

Operating Instructions

Proline Promass A 300

PROFINET

Coriolis flowmeter

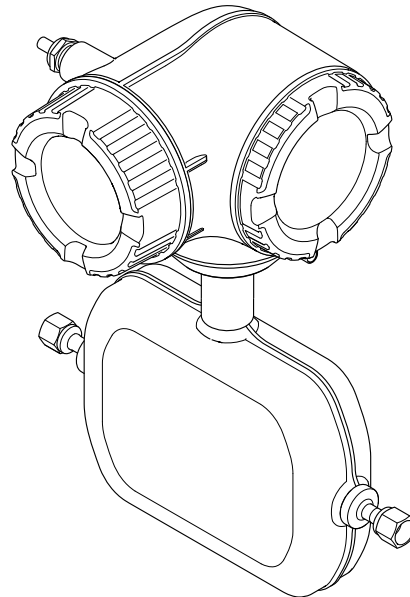

- Make sure the document is stored in a safe place such that it is always available when working on or with the device.
- To avoid danger to individuals or the facility, read the "Basic safety instructions" section carefully, as well as all other safety instructions in the document that are specific to working procedures.
- The manufacturer reserves the right to modify technical data without prior notice. Your Endress+Hauser sales organization will supply you with current information and updates to this manual.

Table of contents

1	About this document	6		
1.1	Document function	6		
1.2	Symbols	6		
1.2.1	Safety symbols	6		
1.2.2	Electrical symbols	6		
1.2.3	Communication-specific symbols	6		
1.2.4	Tool symbols	7		
1.2.5	Symbols for certain types of information	7		
1.2.6	Symbols in graphics	7		
1.3	Documentation	8		
1.4	Registered trademarks	8		
2	Safety instructions	9		
2.1	Requirements for the personnel	9		
2.2	Intended use	9		
2.3	Workplace safety	10		
2.4	Operational safety	10		
2.5	Product safety	10		
2.6	IT security	11		
2.7	Device-specific IT security	11		
2.7.1	Protecting access via hardware write protection	11		
2.7.2	Protecting access via a password	11		
2.7.3	Access via web server	12		
2.7.4	Access via service interface (CDI- RJ45)	12		
3	Product description	14		
3.1	Product design	14		
4	Incoming acceptance and product identification	15		
4.1	Incoming acceptance	15		
4.2	Product identification	15		
4.2.1	Transmitter nameplate	16		
4.2.2	Sensor nameplate	17		
4.2.3	Symbols on the device	18		
5	Storage and transport	19		
5.1	Storage conditions	19		
5.2	Transporting the product	19		
5.2.1	Measuring devices without lifting lugs	19		
5.2.2	Measuring devices with lifting lugs	20		
5.2.3	Transporting with a fork lift	20		
5.3	Packaging disposal	20		
6	Mounting	21		
6.1	Mounting requirements	21		
6.1.1	Installation position	21		
6.1.2	Environmental and process requirements	23		
6.1.3	Special installation instructions	24		
6.2	Mounting the measuring instrument	28		
6.2.1	Required tools	28		
6.2.2	Preparing the measuring instrument	28		
6.2.3	Mounting the measuring device	28		
6.2.4	Turning the transmitter housing	29		
6.2.5	Turning the display module	30		
6.3	Post-installation check	31		
7	Electrical connection	32		
7.1	Electrical safety	32		
7.2	Connecting requirements	32		
7.2.1	Required tools	32		
7.2.2	Requirements for connection cable	32		
7.2.3	Terminal assignment	35		
7.2.4	Available device plugs	35		
7.2.5	device plug pin assignment	35		
7.2.6	Preparing the measuring device	35		
7.3	Connecting the measuring instrument	36		
7.3.1	Connecting the transmitter	36		
7.3.2	Integrating the transmitter into a network	39		
7.3.3	Connecting the remote display and operating module DKX001	41		
7.4	Potential equalization	41		
7.4.1	Requirements	41		
7.5	Special connection instructions	42		
7.5.1	Connection examples	42		
7.6	Hardware settings	45		
7.6.1	Setting the device name	45		
7.6.2	Activating the default IP address	47		
7.7	Ensuring the degree of protection	47		
7.8	Post-connection check	48		
8	Operation options	49		
8.1	Overview of operation options	49		
8.2	Structure and function of the operating menu	50		
8.2.1	Structure of the operating menu	50		
8.2.2	Operating philosophy	51		
8.3	Access to operating menu via local display	52		
8.3.1	Operational display	52		
8.3.2	Navigation view	54		
8.3.3	Editing view	56		
8.3.4	Operating elements	58		
8.3.5	Opening the context menu	58		
8.3.6	Navigating and selecting from list	60		
8.3.7	Calling the parameter directly	60		
8.3.8	Calling up help text	61		
8.3.9	Changing the parameters	61		
8.3.10	User roles and related access authorization	62		

8.3.11	Disabling write protection via access code	62	10.6	Advanced settings	117
8.3.12	Enabling and disabling the keypad lock	63	10.6.1	Using the parameter to enter the access code	118
8.4	Access to operating menu via web browser . . .	63	10.6.2	Calculated process variables	118
8.4.1	Function range	63	10.6.3	Carrying out a sensor adjustment . . .	120
8.4.2	Requirements	64	10.6.4	Configuring the totalizer	126
8.4.3	Connecting the device	65	10.6.5	Carrying out additional display configurations	128
8.4.4	Logging on	67	10.6.6	WLAN configuration	131
8.4.5	User interface	68	10.6.7	Viscosity application package	133
8.4.6	Disabling the Web server	69	10.6.8	Concentration Measurement application package	133
8.4.7	Logging out	69	10.6.9	Petroleum application package	133
8.5	Access to the operating menu via the operating tool	70	10.6.10	Heartbeat Technology application package	133
8.5.1	Connecting the operating tool	70	10.6.11	Configuration management	134
8.5.2	FieldCare	73	10.6.12	Using parameters for device administration	135
8.5.3	DeviceCare	74	10.7	Simulation	136
9	System integration	76	10.8	Protecting settings from unauthorized access	139
9.1	Overview of device description files	76	10.8.1	Write protection via access code . . .	139
9.1.1	Current version data for the device . . .	76	10.8.2	Write protection via write protection switch	140
9.1.2	Operating tools	76	11	Operation	142
9.2	Device master file (GSD)	76	11.1	Reading off the device locking status	142
9.2.1	File name of the manufacturer-specific device master file (GSD)	77	11.2	Adjusting the operating language	142
9.2.2	File name of the PA Profile device master file (GSD)	77	11.3	Configuring the display	142
9.3	Cyclic data transmission	78	11.4	Reading measured values	142
9.3.1	Overview of the modules	78	11.4.1	"Measured variables" submenu	143
9.3.2	Description of the modules	79	11.4.2	Totalizer	145
9.3.3	Status coding	84	11.4.3	"Input values" submenu	146
9.3.4	Factory setting	85	11.4.4	Output values	147
9.4	System redundancy S2	86	11.5	Adapting the measuring device to the process conditions	149
10	Commissioning	87	11.6	Performing a totalizer reset	149
10.1	Post-mounting and post-connection check . . .	87	11.6.1	Function scope of "Control Totalizer" parameter	150
10.2	Switching on the measuring device	87	11.6.2	Function range of "Reset all totalizers" parameter	150
10.3	Connecting via FieldCare	87	11.7	Displaying the measured value history	150
10.4	Setting the operating language	87	11.8	Gas Fraction Handler	153
10.5	Configuring the measuring instrument	88	11.8.1	"Measurement mode" submenu	154
10.5.1	Defining the tag name	89	11.8.2	"Medium index" submenu	154
10.5.2	Displaying the communication interface	89	12	Diagnostics and troubleshooting . .	155
10.5.3	Setting the system units	90	12.1	General troubleshooting	155
10.5.4	Selecting and setting the medium . . .	93	12.2	Diagnostic information via light emitting diodes	157
10.5.5	Configuration of the Analog Inputs . .	95	12.2.1	Transmitter	157
10.5.6	Displaying the I/O configuration	95	12.3	Diagnostic information on local display	159
10.5.7	Configuring the current input	96	12.3.1	Diagnostic message	159
10.5.8	Configuring the status input	97	12.3.2	Calling up remedial measures	161
10.5.9	Configuring the current output	98	12.4	Diagnostic information in the web browser . .	161
10.5.10	Configuring the pulse/frequency/switch output	102	12.4.1	Diagnostic options	161
10.5.11	Configuring the relay output	109	12.4.2	Calling up remedy information	162
10.5.12	Configuring the local display	112			
10.5.13	Configuring the low flow cut off	115			
10.5.14	Configuring partially filled pipe detection	116			

12.5	Diagnostic information in FieldCare or DeviceCare	162	16.7	Mounting	243
12.5.1	Diagnostic options	162	16.8	Environment	243
12.5.2	Calling up remedy information	163	16.9	Process	245
12.6	Adapting the diagnostic information	164	16.10	Mechanical construction	246
12.6.1	Adapting the diagnostic behavior	164	16.11	Operability	250
12.7	Overview of diagnostic information	167	16.12	Certificates and approvals	254
12.7.1	Diagnostic of sensor	167	16.13	Application packages	257
12.7.2	Diagnostic of electronic	174	16.14	Accessories	258
12.7.3	Diagnostic of configuration	191	16.15	Supplementary documentation	258
12.7.4	Diagnostic of process	204			
12.8	Pending diagnostic events	218	Index		260
12.9	Diagnostics list	218			
12.10	Event logbook	219			
12.10.1	Reading out the event logbook	219			
12.10.2	Filtering the event logbook	220			
12.10.3	Overview of information events	220			
12.11	Resetting the measuring device	221			
12.11.1	Function range of "Device reset" parameter	221			
12.12	Device information	222			
12.13	Firmware history	223			
13	Maintenance	224			
13.1	Maintenance work	224			
13.1.1	Exterior cleaning	224			
13.1.2	Internal cleaning	224			
13.2	Measuring and test equipment	224			
13.3	Endress+Hauser services	224			
14	Repair	225			
14.1	General notes	225			
14.1.1	Repair and conversion concept	225			
14.1.2	Notes for repair and conversion	225			
14.2	Spare parts	225			
14.3	Endress+Hauser services	225			
14.4	Return	225			
14.5	Disposal	226			
14.5.1	Removing the measuring device	226			
14.5.2	Disposing of the measuring device	226			
15	Accessories	227			
15.1	Device-specific accessories	227			
15.1.1	For the transmitter	227			
15.1.2	For the sensor	228			
15.2	Communication-specific accessories	228			
15.3	Service-specific accessories	229			
15.4	System components	229			
16	Technical data	230			
16.1	Application	230			
16.2	Function and system design	230			
16.3	Input	231			
16.4	Output	233			
16.5	Power supply	238			
16.6	Performance characteristics	239			

1 About this document

1.1 Document function

These Operating Instructions contain all the information required in the various life cycle phases of the device: from product identification, incoming acceptance and storage, to installation, connection, operation and commissioning, through to troubleshooting, maintenance and disposal.

1.2 Symbols

1.2.1 Safety symbols

DANGER

This symbol alerts you to a dangerous situation. Failure to avoid this situation will result in serious or fatal injury.

WARNING

This symbol alerts you to a potentially dangerous situation. Failure to avoid this situation can result in serious or fatal injury.





CAUTION

This symbol alerts you to a potentially dangerous situation. Failure to avoid this situation can result in minor or medium injury.

NOTICE

This symbol alerts you to a potentially harmful situation. Failure to avoid this situation can result in damage to the product or something in its vicinity.



1.2.2 Electrical symbols

Symbol	Meaning
	Direct current
	Alternating current
	Direct current and alternating current
	Ground connection A grounded terminal which, as far as the operator is concerned, is grounded via a grounding system.
	Potential equalization connection (PE: protective earth) Ground terminals that must be connected to ground prior to establishing any other connections. The ground terminals are located on the interior and exterior of the device: <ul style="list-style-type: none"> ▪ Interior ground terminal: potential equalization is connected to the supply network. ▪ Exterior ground terminal: device is connected to the plant grounding system.













1.2.3 Communication-specific symbols

Symbol	Meaning
	Wireless Local Area Network (WLAN) Communication via a wireless, local network.





1.2.4 Tool symbols

Symbol	Meaning
	Flat-blade screwdriver
	Allen key
	Open-ended wrench

1.2.5 Symbols for certain types of information

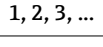
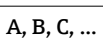
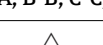
Symbol	Meaning
	Permitted Procedures, processes or actions that are permitted.
	Preferred Procedures, processes or actions that are preferred.
	Forbidden Procedures, processes or actions that are forbidden.
	Tip Indicates additional information.
	Reference to documentation
	Reference to page
	Reference to graphic
	Notice or individual step to be observed
	Series of steps
	Result of a step
	Help in the event of a problem
	Visual inspection

1.2.6 Symbols in graphics

Symbol	Meaning
	Item numbers
	Series of steps
	Views
	Sections
	Hazardous area
	Safe area (non-hazardous area)
	Flow direction

1.3 Documentation

 For an overview of the scope of the associated Technical Documentation, refer to the following:

- *Device Viewer* (www.endress.com/deviceviewer): Enter the serial number from the nameplate
- *Endress+Hauser Operations app*: Enter serial number from nameplate or scan matrix code on nameplate.

The following documentation may be available depending on the device version ordered:

Document type	Purpose and content of the document
Technical Information (TI)	Planning aid for your device The document contains all the technical data on the device and provides an overview of the accessories and other products that can be ordered for the device.
Brief Operating Instructions (KA)	Guide that takes you quickly to the 1st measured value The Brief Operating Instructions contain all the essential information from incoming acceptance to initial commissioning.
Operating Instructions (BA)	Your reference document These Operating Instructions contain all the information that is required in the various life cycle phases of the device: from product identification, incoming acceptance and storage, to mounting, connection, operation and commissioning, through to troubleshooting, maintenance and disposal.
Description of Device Parameters (GP)	Reference for your parameters The document provides a detailed explanation of each individual parameter. The description is aimed at those who work with the device over the entire life cycle and perform specific configurations.
Safety Instructions (XA)	Depending on the approval, safety instructions for electrical equipment in hazardous areas are also supplied with the device. The Safety Instructions are a constituent part of the Operating Instructions.  Information on the Safety Instructions (XA) that are relevant for the device is provided on the nameplate.
Supplementary device-dependent documentation (SD/FY)	Always comply strictly with the instructions in the relevant supplementary documentation. The supplementary documentation is a constituent part of the device documentation.

1.4 Registered trademarks

PROFINET®

Registered trademark of the PROFIBUS Nutzerorganisation e.V. (PROFIBUS User Organization), Karlsruhe, Germany

TRI-CLAMP®

Registered trademark of Ladish & Co., Inc., Kenosha, USA

2 Safety instructions

2.1 Requirements for the personnel

The personnel for installation, commissioning, diagnostics and maintenance must fulfill the following requirements:

- ▶ Trained, qualified specialists must have a relevant qualification for this specific function and task.
- ▶ Are authorized by the plant owner/operator.
- ▶ Are familiar with federal/national regulations.
- ▶ Before starting work, read and understand the instructions in the manual and supplementary documentation as well as the certificates (depending on the application).
- ▶ Follow instructions and comply with basic conditions.

The operating personnel must fulfill the following requirements:

- ▶ Are instructed and authorized according to the requirements of the task by the facility's owner-operator.
- ▶ Follow the instructions in this manual.

2.2 Intended use

Application and media

The measuring instrument described in this manual is intended only for the flow measurement of liquids and gases.

Depending on the version ordered, the measuring instrument can also be used to measure potentially explosive ¹⁾, flammable, toxid and oxidizing media.

Measuring instruments for use in hazardous areas, in hygienic applications, or where there is an increased risk due to pressure, are specially labeled on the nameplate.

To ensure that the measuring instrument is in perfect condition during operation:

- ▶ Only use the measuring instrument in full compliance with the data on the nameplate and the general conditions listed in the Operating Instructions and supplementary documentation.
- ▶ Using the nameplate, check whether the ordered device is permitted for the intended use in the hazardous area (e.g. explosion protection, pressure vessel safety).
- ▶ Use the measuring instrument only for media to which the process-wetted materials are sufficiently resistant.
- ▶ Keep within the specified pressure and temperature range.
- ▶ Keep within the specified ambient temperature range.
- ▶ Protect the measuring instrument permanently against corrosion from environmental influences.

Incorrect use

Non-designated use can compromise safety. The manufacturer is not liable for damage caused by improper or non-designated use.

WARNING

Danger of breakage due to corrosive or abrasive fluids and ambient conditions!

- ▶ Verify the compatibility of the process fluid with the sensor material.
- ▶ Ensure the resistance of all fluid-wetted materials in the process.
- ▶ Keep within the specified pressure and temperature range.

1) Not applicable for IO-Link measuring instruments

NOTICE**Verification for borderline cases:**

- ▶ For special fluids and fluids for cleaning, Endress+Hauser is glad to provide assistance in verifying the corrosion resistance of fluid-wetted materials, but does not accept any warranty or liability as minute changes in the temperature, concentration or level of contamination in the process can alter the corrosion resistance properties.

Residual risks**⚠ CAUTION**

Risk of hot or cold burns! The use of media and electronics with high or low temperatures can produce hot or cold surfaces on the device.

- ▶ Mount suitable touch protection.

⚠ WARNING

Danger of housing breaking due to measuring tube breakage!

If a measuring tube ruptures, the pressure inside the sensor housing will rise according to the operating process pressure.

- ▶ Use a rupture disk.

⚠ WARNING

Danger from medium escaping!

For device versions with a rupture disk: medium escaping under pressure can cause injury or material damage.

- ▶ Take precautions to prevent injury and material damage if the rupture disk is actuated.

2.3 Workplace safety

When working on and with the device:

- ▶ Wear the required personal protective equipment as per national regulations.

2.4 Operational safety

Damage to the device!

- ▶ Operate the device in proper technical condition and fail-safe condition only.
- ▶ The operator is responsible for the interference-free operation of the device.

Modifications to the device

Unauthorized modifications to the device are not permitted and can lead to unforeseeable dangers!

- ▶ If modifications are nevertheless required, consult with the manufacturer.

Repair

To ensure continued operational safety and reliability:

- ▶ Carry out repairs on the device only if they are expressly permitted.
- ▶ Observe federal/national regulations pertaining to the repair of an electrical device.
- ▶ Use only original spare parts and accessories.

2.5 Product safety

This measuring device is designed in accordance with good engineering practice to meet state-of-the-art safety requirements, has been tested, and left the factory in a condition in which it is safe to operate.

It meets general safety standards and legal requirements. It also complies with the EU directives listed in the device-specific EU Declaration of Conformity. The manufacturer confirms this by affixing the CE mark to the device..





2.6 IT security

The manufacturer warranty is valid only if the product is installed and used as described in the Operating Instructions. The product is equipped with security mechanisms to protect it against any inadvertent changes to the settings.

IT security measures, which provide additional protection for the product and associated data transfer, must be implemented by the operators themselves in line with their security standards.

2.7 Device-specific IT security

The device offers a range of specific functions to support protective measures on the operator's side. These functions can be configured by the user and guarantee greater in-operation safety if used correctly. The following list provides an overview of the most important functions:

Function/interface	Factory setting	Recommendation
Write protection via hardware write protection switch →  11	Not enabled	On an individual basis following risk assessment
Access code (also applies to web server login or FieldCare connection) →  12	Not enabled (0000)	Assign a customized access code during commissioning
WLAN (order option in display module)	Enabled	On an individual basis following risk assessment
WLAN security mode	Enabled (WPA2-PSK)	Do not change
WLAN passphrase (Password) →  12	Serial number	Assign an individual WLAN passphrase during commissioning
WLAN mode	Access point	On an individual basis following risk assessment
Web server →  12	Enabled	On an individual basis following risk assessment
Service interface CDI-RJ45 →  12	–	On an individual basis following risk assessment

2.7.1 Protecting access via hardware write protection

Write access to the parameters of the device via the local display, web browser or operating tool (e.g. FieldCare, DeviceCare) can be disabled via a write protection switch (DIP switch on the main electronics module). When hardware write protection is enabled, only read access to the parameters is possible.

Hardware write protection is disabled when the device is delivered →  140.

2.7.2 Protecting access via a password

Different passwords are available to protect write access to the device parameters or access to the device via the WLAN interface.

- **User-specific access code**
Protect write access to the device parameters via the local display, web browser or operating tool (e.g. FieldCare, DeviceCare). Access authorization is clearly regulated through the use of a user-specific access code.
- **WLAN passphrase**
The network key protects a connection between an operating unit (e.g. notebook or tablet) and the device via the WLAN interface which can be ordered as an option.
- **Infrastructure mode**
When the device is operated in infrastructure mode, the WLAN passphrase corresponds to the WLAN passphrase configured on the operator side.

User-specific access code

Write access to the device parameters via the local display, web browser or operating tool (e.g. FieldCare, DeviceCare) can be protected by the modifiable, user-specific access code (→  139).

When the device is delivered, the device does not have an access code and is equivalent to 0000 (open).

WLAN passphrase: Operation as WLAN access point

A connection between an operating unit (e.g. notebook or tablet) and the device via the WLAN interface (→  72), which can be ordered as an optional extra, is protected by the network key. The WLAN authentication of the network key complies with the IEEE 802.11 standard.

When the device is delivered, the network key is pre-defined depending on the device. It can be changed via the **WLAN settings** submenu in the **WLAN passphrase** parameter (→  132).

Infrastructure mode

A connection between the device and WLAN access point is protected by means of an SSID and passphrase on the system side. Please contact the relevant system administrator for access.

General notes on the use of passwords

- The access code and network key supplied with the device should be changed during commissioning for safety reasons.
- Follow the general rules for generating a secure password when defining and managing the access code and network key.
- The user is responsible for the management and careful handling of the access code and network key.
- For information on configuring the access code or on what to do if you lose the password, for example, see "Write protection via access code" →  139.

2.7.3 Access via web server

The integrated web server can be used to operate and configure the device via a web browser →  63. The connection is established via the service interface (CDI-RJ45), the terminal connection for signal transmission with PROFINET (RJ45 plug) or the WLAN interface.

The web server is enabled when the device is delivered. The web server can be disabled via the **Web server functionality** parameter if necessary (e.g., after commissioning).

The device and status information can be hidden on the login page. This prevents unauthorized access to the information.



Detailed information on the device parameters:
"Description of device parameters" document .

2.7.4 Access via service interface (CDI-RJ45)



The device can be connected to a network via the service interface (CDI-RJ45). Device-specific functions guarantee the secure operation of the device in a network.

The use of relevant industrial standards and guidelines that have been defined by national and international safety committees, such as IEC/ISA62443 or the IEEE, is recommended.

This includes organizational security measures such as the assignment of access authorization as well as technical measures such as network segmentation.

 Transmitters with an Ex de approval may not be connected via the service interface (CDI-RJ45)!

Order code for "Approval transmitter + sensor", options (Ex de): BA, BB, C1, C2, GA, GB, MA, MB, NA, NB BB, C2, GB, MB, NB

 The device can be integrated into a ring topology. The device is integrated via the terminal connection for signal transmission (output 1) and the connection to the service interface (CDI-RJ45) →  40.

3 Product description

The device consists of a transmitter and a sensor.

The device is available as a compact version:

The transmitter and sensor form a mechanical unit.

3.1 Product design

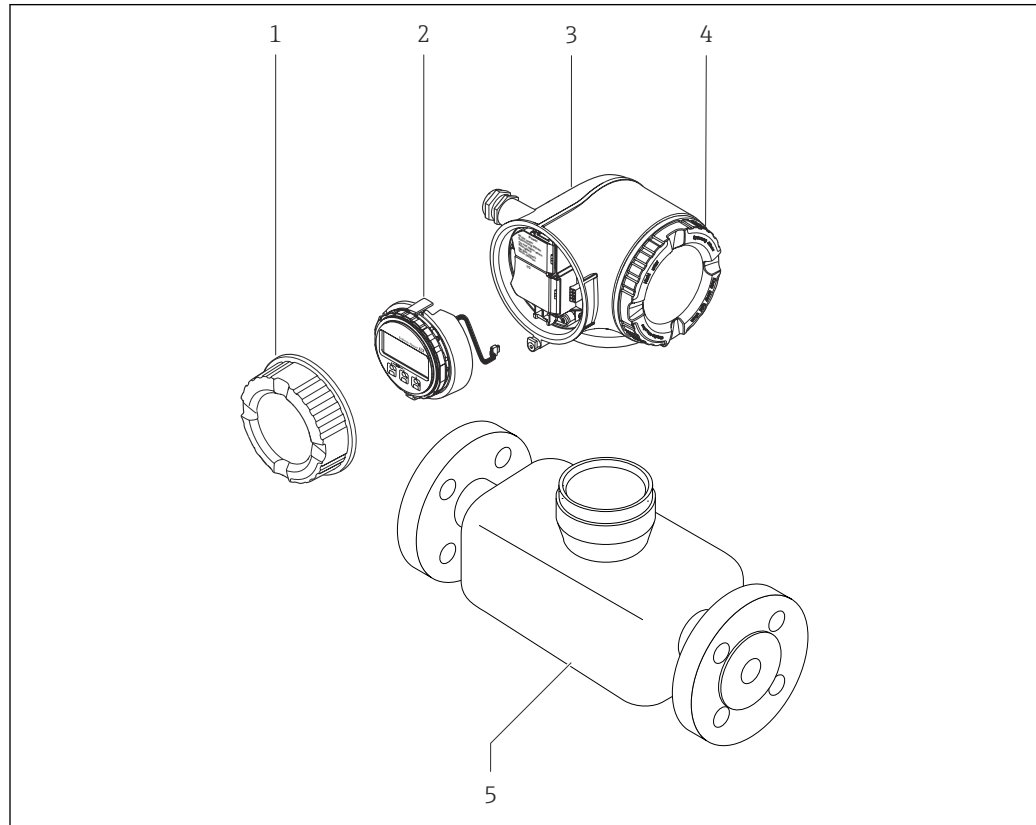

A0029586

☐ 1 *Important components of a measuring device*

- 1 *Connection compartment cover*
- 2 *Display module*
- 3 *Transmitter housing*
- 4 *Electronics compartment cover*
- 5 *Sensor*

4 Incoming acceptance and product identification

4.1 Incoming acceptance

On receipt of the delivery:

1. Check the packaging for damage.
 - ↳ Report all damage immediately to the manufacturer.
Do not install damaged components.
2. Check the scope of delivery using the delivery note.
3. Compare the data on the nameplate with the order specifications on the delivery note.
4. Check the technical documentation and all other necessary documents, e.g. certificates, to ensure they are complete.

 If one of the conditions is not satisfied, contact the manufacturer.

4.2 Product identification

The device can be identified in the following ways:

- Nameplate
- Order code with details of the device features on the delivery note
- Enter the serial numbers from the nameplates in the *Device Viewer* (www.endress.com/deviceviewer): all the information about the device is displayed.
- Enter the serial numbers from the nameplates into the *Endress+Hauser Operations app* or scan the DataMatrix code on the nameplate with the *Endress+Hauser Operations app*: all the information about the device is displayed.

For an overview of the scope of the associated Technical Documentation, refer to the following:

- The "Additional standard device documentation" and "Supplementary device-dependent documentation" sections
- The *Device Viewer*: Enter the serial number from the nameplate (www.endress.com/deviceviewer)
- The *Endress+Hauser Operations app*: Enter the serial number from the nameplate or scan the DataMatrix code on the nameplate.

4.2.1 Transmitter nameplate

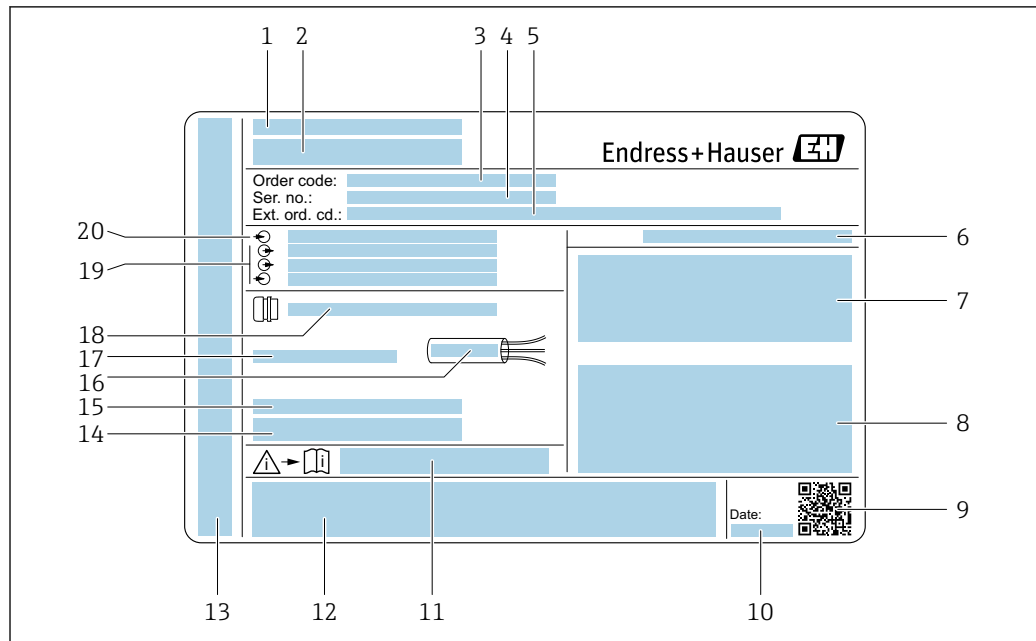

A0029192

 2 Example of a transmitter nameplate

- 1 Manufacturer address/certificate holder
- 2 Name of the transmitter
- 3 Order code
- 4 Serial number
- 5 Extended order code
- 6 Degree of protection
- 7 Space for approvals: use in hazardous areas
- 8 Electrical connection data: available inputs and outputs
- 9 2-D matrix code
- 10 Date of manufacture: year-month
- 11 Document number of safety-related supplementary documentation
- 12 Space for approvals and certificates: e.g. CE mark, RCM tick
- 13 Space for degree of protection of connection and electronics compartment when used in hazardous areas
- 14 Firmware version (FW) and device revision (Dev. rev.) from the factory
- 15 Space for additional information in the case of special products
- 16 Permitted temperature range for cable
- 17 Permitted ambient temperature (T_a)
- 18 Information on cable gland
- 19 Available inputs and outputs, supply voltage
- 20 Electrical connection data: supply voltage

4.2.2 Sensor nameplate

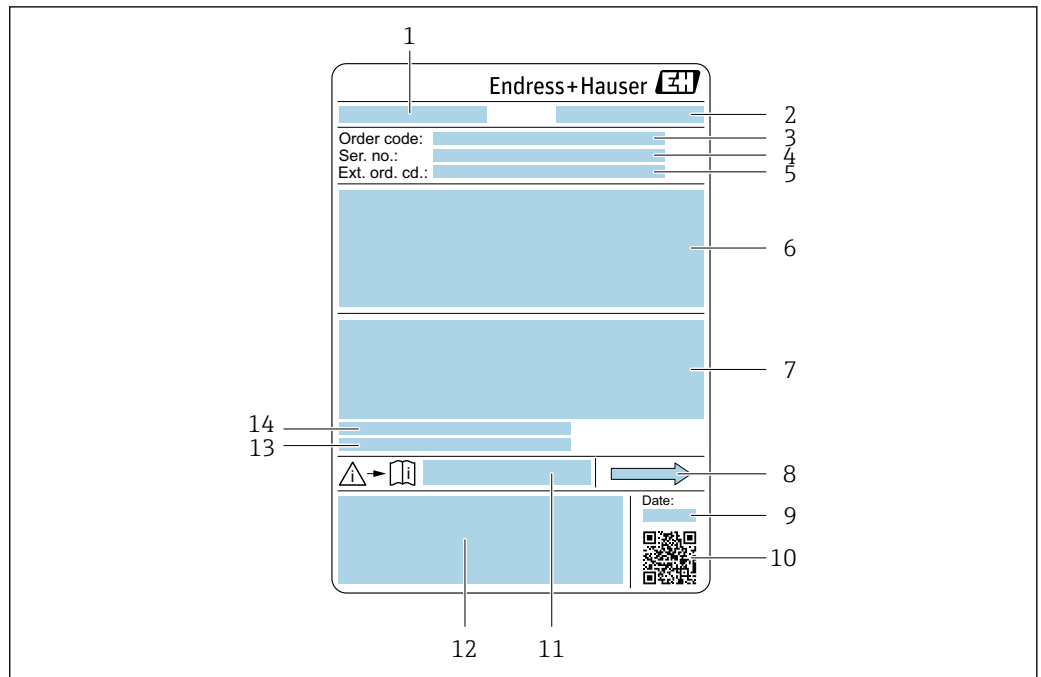

A0029199

 3 Example of a sensor nameplate

- 1 Name of the sensor
- 2 Manufacturer address/certificate holder
- 3 Order code
- 4 Serial number (Ser. no.)
- 5 Extended order code (Ext. ord. cd.)
- 6 Nominal diameter of the sensor; flange nominal diameter/nominal pressure; sensor test pressure; medium temperature range; material of measuring tube and manifold; sensor-specific information: e.g. pressure range of sensor housing, wide-range density specification (special density calibration)
- 7 Approval information for explosion protection, Pressure Equipment Directive and degree of protection
- 8 Flow direction
- 9 Date of manufacture: year-month
- 10 2-D matrix code
- 11 Document number of safety-related supplementary documentation
- 12 CE mark, RCM-Tick mark
- 13 Surface roughness
- 14 Allowable ambient temperature (T_a)





Order code

The measuring device is reordered using the order code.

Extended order code

- The device type (product root) and basic specifications (mandatory features) are always listed.
- Of the optional specifications (optional features), only the safety and approval-related specifications are listed (e.g. LA). If other optional specifications are also ordered, these are indicated collectively using the # placeholder symbol (e.g. #LA#).
- If the ordered optional specifications do not include any safety and approval-related specifications, they are indicated by the + placeholder symbol (e.g. XXXXXX-ABCDE+).

4.2.3 Symbols on the device

Symbol	Meaning
	WARNING! This symbol alerts you to a dangerous situation. Failure to avoid this situation can result in serious or fatal injury. Please consult the documentation for the measuring instrument to discover the type of potential danger and measures to avoid it.
	Reference to documentation Refers to the corresponding device documentation.
	Protective ground connection A terminal that must be connected to the ground prior to establishing any other connections.

5 Storage and transport

5.1 Storage conditions

Observe the following notes for storage:

- ▶ Store in the original packaging to ensure protection from shock.
- ▶ Do not remove protective covers or protective caps installed on process connections. They prevent mechanical damage to the sealing surfaces and contamination in the measuring tube.
- ▶ Protect from direct sunlight. Avoid unacceptably high surface temperatures.
- ▶ Store in a dry and dust-free place.
- ▶ Do not store outdoors.

Storage temperature →  243

5.2 Transporting the product

Transport the measuring device to the measuring point in the original packaging.

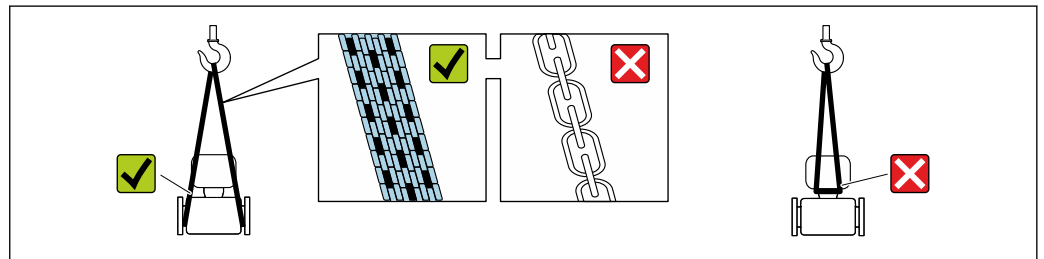

A0029252

-  Do not remove protective covers or caps installed on process connections. They prevent mechanical damage to the sealing surfaces and contamination in the measuring tube.

5.2.1 Measuring devices without lifting lugs

WARNING

Center of gravity of the measuring device is higher than the suspension points of the webbing slings.

Risk of injury if the measuring device slips.

- ▶ Secure the measuring device against slipping or turning.
- ▶ Observe the weight specified on the packaging (stick-on label).



A0029214

5.2.2 Measuring devices with lifting lugs

⚠ CAUTION

Special transportation instructions for devices with lifting lugs

- ▶ Only use the lifting lugs fitted on the device or flanges to transport the device.
- ▶ The device must always be secured at two lifting lugs at least.

5.2.3 Transporting with a fork lift

If transporting in wood crates, the floor structure enables the crates to be lifted lengthwise or at both sides using a forklift.

5.3 Packaging disposal

All packaging materials are environmentally friendly and 100% recyclable:

- Outer packaging of device
 - Stretch wrap made of polymer in accordance with EU Directive 2002/95/EC (RoHS)
- Packaging
 - Wood crate treated in accordance with ISPM 15 standard, confirmed by IPPC logo
 - Cardboard box in accordance with European packaging guideline 94/62/EC, recyclability confirmed by Resy symbol
- Transport material and fastening fixtures
 - Disposable plastic pallet
 - Plastic straps
 - Plastic adhesive strips
- Filler material
 - Paper pads

6 Mounting

6.1 Mounting requirements

6.1.1 Installation position

Installation point

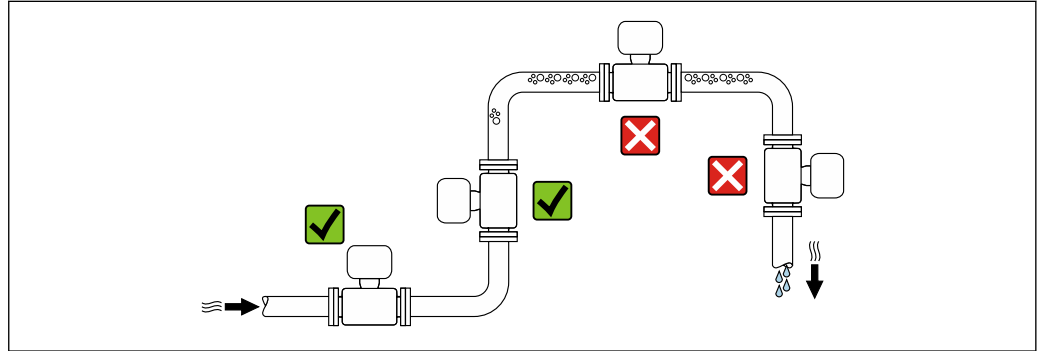

A0028772

To prevent measuring errors arising from accumulation of gas bubbles in the measuring pipe, avoid the following mounting locations in the piping:

- Highest point of a pipeline.
- Directly upstream of a free pipe outlet in a down pipe.

Installation in down pipes

However, the following installation suggestion allows for installation in an open vertical pipeline. Pipe restrictions or the use of an orifice with a smaller cross-section than the nominal diameter prevent the sensor running empty while measurement is in progress.

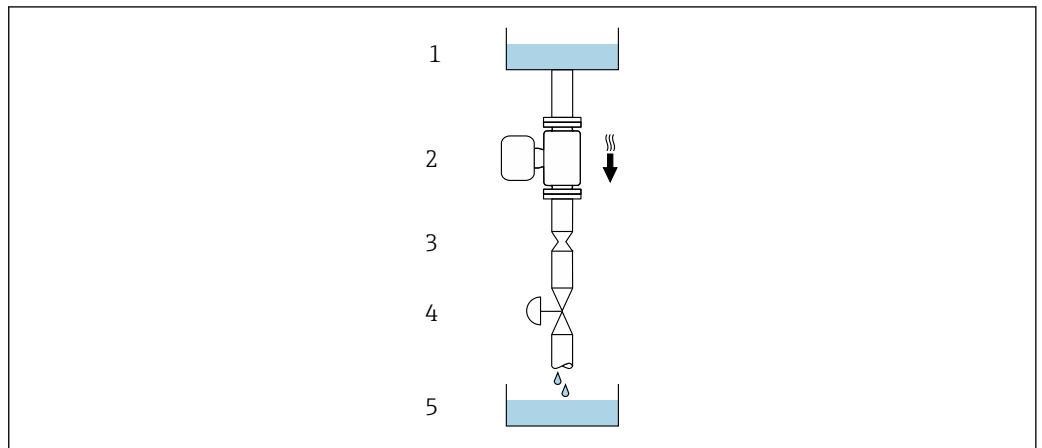

A0028773



4 Installation in a down pipe (e.g. for batching applications)

- 1 Supply tank
- 2 Sensor
- 3 Orifice plate, pipe restriction
- 4 Valve
- 5 Filling vessel

DN		Ø orifice plate, pipe restriction	
[mm]	[in]	[mm]	[in]
1	1/24	0.8	0.03
2	1/12	1.5	0.06
4	1/8	3.0	0.12

Orientation

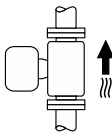
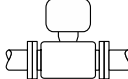
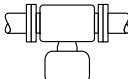
The direction of the arrow on the sensor nameplate helps you to install the sensor according to the flow direction (direction of medium flow through the piping).

Orientation			Recommendation
A	Vertical orientation	 A0015591	✓✓ ¹⁾
B	Horizontal orientation, transmitter at top	 A0015589	✓ ²⁾
C	Horizontal orientation, transmitter at bottom	 A0015590	✓ ³⁾
D	Horizontal orientation, transmitter at side	 A0015592	✓

- 1) This orientation is recommended to ensure self-draining.
- 2) Applications with low process temperatures may reduce the ambient temperature. To maintain the minimum ambient temperature for the transmitter, this orientation is recommended.
- 3) Applications with high process temperatures may increase the ambient temperature. To maintain the maximum ambient temperature for the transmitter, this orientation is recommended.

If a sensor is installed horizontally with a curved measuring tube, match the position of the sensor to the fluid properties.

Inlet and outlet runs

No special precautions need to be taken for fittings that create turbulence, such as valves, elbows or T-pieces, as long as no cavitation occurs → 23.

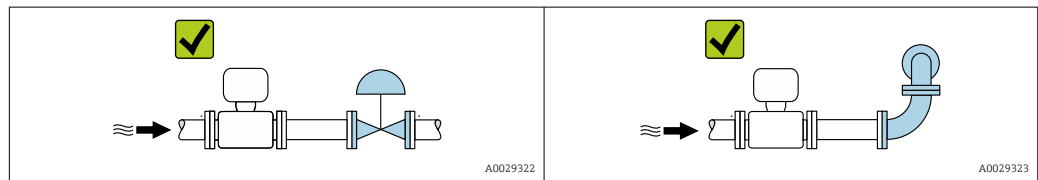

Installation dimensions

 For the dimensions and installation lengths of the device, see the "Technical Information" document, "Mechanical construction" section

6.1.2 Environmental and process requirements

Ambient temperature range

Measuring device	<ul style="list-style-type: none"> ■ -40 to +60 °C (-40 to +140 °F) ■ Order code for "Test, certificate", option JP: -50 to +60 °C (-58 to +140 °F)
Readability of the local display	-20 to +60 °C (-4 to +140 °F) The readability of the display may be impaired at temperatures outside the temperature range.

 Dependency of ambient temperature on medium temperature →  245

- ▶ If operating outdoors:
Avoid direct sunlight, particularly in warm climatic regions.

Static pressure

It is important that cavitation does not occur, or that gases entrained in the liquids do not outgas.

Cavitation is caused if the pressure drops below the vapor pressure:

- In liquids that have a low boiling point (e.g. hydrocarbons, solvents, liquefied gases)
- In suction lines
- ▶ Ensure the static pressure is sufficiently high to prevent cavitation and outgassing.

For this reason, the following mounting locations are recommended:

- At the lowest point in a vertical pipe
- Downstream from pumps (no danger of vacuum)

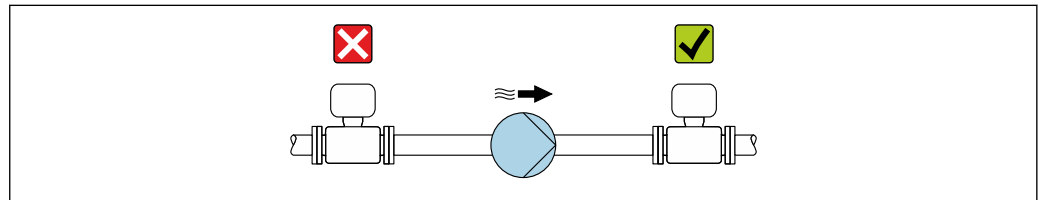

A0028777

Thermal insulation

In the case of some fluids, it is important to keep the heat radiated from the sensor to the transmitter to a low level. A wide range of materials can be used for the required insulation.

NOTICE

Electronics overheating on account of thermal insulation!

- ▶ Recommended orientation: horizontal orientation, transmitter housing pointing downwards.
- ▶ Do not insulate the transmitter housing .
- ▶ Maximum permissible temperature at the lower end of the transmitter housing: 80 °C (176 °F)
- ▶ Regarding thermal insulation with an exposed extended neck: We advise against insulating the extended neck to ensure optimal heat dissipation.

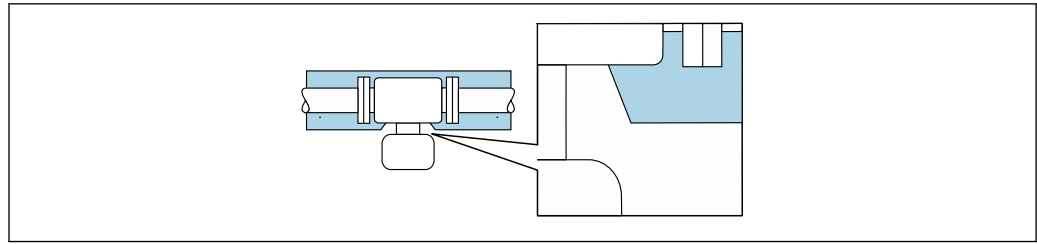

5 Thermal insulation with exposed extended neck

Heating

NOTICE

Electronics can overheat due to elevated ambient temperature!

- ▶ Observe maximum permitted ambient temperature for the transmitter.
- ▶ Depending on the medium temperature, take the device orientation requirements into account.

NOTICE

Danger of overheating when heating

- ▶ Ensure that the temperature at the lower end of the transmitter housing does not exceed 80 °C (176 °F).
- ▶ Ensure that sufficient convection takes place at the transmitter neck.
- ▶ Ensure that a sufficiently large area of the transmitter neck remains exposed. The uncovered part serves as a radiator and protects the electronics from overheating and excessive cooling.
- ▶ When using in potentially explosive atmospheres, observe the information in the device-specific Ex documentation. For detailed information on the temperature tables, see the separate document entitled "Safety Instructions" (XA) for the device.
- ▶ Consider the "830 ambient temperature too high" and "832 electronics temperature too high" process diagnostics if overheating cannot be ruled out based on a suitable system design.

Heating options

If a fluid requires that no heat loss should occur at the sensor, users can avail of the following heating options:

- Electrical heating, e.g. with electric band heaters ²⁾
- Via pipes carrying hot water or steam
- Via heating jackets

Vibrations

The high oscillation frequency of the measuring tubes ensures that the correct operation of the measuring system is not influenced by plant vibrations.

6.1.3 Special installation instructions



Drainability

When the device is installed in a vertical position, the measuring tube can be drained completely and protected against deposit buildup if the properties of the measured liquid allow this. Furthermore, as only one measuring tube is used the flow is not impeded and the risk of product being retained in the measuring device is reduced to a minimum. The

2) The use of parallel electric band heaters is generally recommended (bidirectional electricity flow). Particular considerations must be made if a single-wire heating cable is to be used. For additional information, refer to EA01339D "Installation Instructions for Electrical Trace Heating Systems".

larger internal diameter of the measuring tube ³⁾ also reduces the risk of particles getting trapped in the measuring system. Due to the larger cross-section of the individual measuring tube, the tube is also generally less susceptible to clogging.

Hygienic compatibility

-  ■ When installing in hygienic applications, please refer to the information in the "Certificates and approvals/hygienic compatibility" section →  255
- In the case of measuring devices with the order code for "Housing", option B "Stainless, hygienic", to seal the connection compartment cover, screw it closed finger-tight and tighten it by another 45° (corresponds to 15 Nm).

Rupture disk

Process-related information: →  245.

WARNING



Danger from medium escaping!

Medium escaping under pressure can cause injury or material damage.

- ▶ Take precautions to prevent danger to persons and damage if the rupture disk is actuated.
- ▶ Observe the information on the rupture disk sticker.
- ▶ Make sure that the function and operation of the rupture disk is not impeded through the installation of the device.
- ▶ Do not remove or damage the rupture disk, drain connection and warning signs.

The position of the rupture disk is indicated by an affixed sticker. In versions without a drain connection (order option CU), the sticker is destroyed if the rupture disk is triggered. The disk can therefore be visually monitored.

To allow any escaping medium to drain in a controlled manner, a drain connection is available for the rupture disk integrated in the sensor: order code for "Sensor option", option CU "Drain connection for rupture disk". This connection is intended for a pipe connection with a 1/4" NPT thread and sealed with a grip plug for protection. To guarantee the function of the rupture disk with a drain connection, the drain connection must be connected to the drain system in a hermetically tight manner.

-  The drain connection is firmly mounted in place by the manufacturer and may not be removed.
-  It is not possible to use the holder with a measuring device with a drain connection for a rupture disk: order code for "Sensor option", option CU "Drain connection for rupture disk"
-  It is not possible to use a heating jacket if the drain connection is used: order code for "Sensor option", option CU "Drain connection for rupture disk"

3) Compared with the double-tube design with a similar flow capacity and measuring tubes with a smaller internal diameter

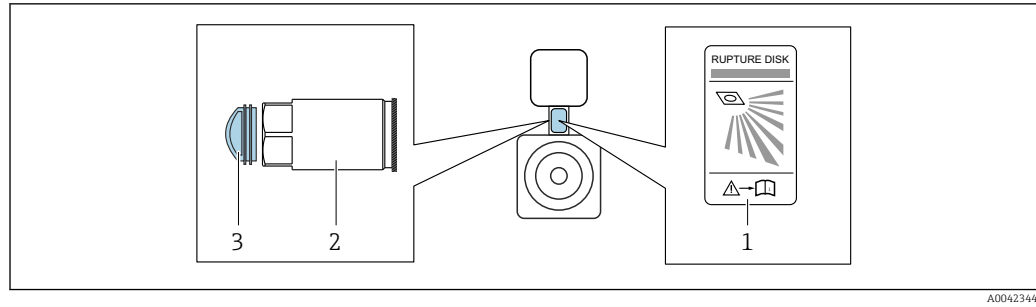

- 1 Rupture disk label
 2 Drain connection for rupture disk with 1/4" NPT internal thread and 17mm width across flats (AF): order code for "Sensor option", option CU, drain connection for rupture disk
 3 Transportation guard

 For information on the dimensions, see the "Technical Information" document, "Mechanical construction" section (accessories).

Zero verification and zero adjustment

All measuring instruments are calibrated in accordance with state-of-the-art technology. Calibration takes place under reference conditions →  239. Therefore, a zero adjustment in the field is generally not required.

Experience shows that zero adjustment is advisable only in special cases:

- To achieve maximum measurement accuracy even with low flow rates.
- Under extreme process or operating conditions (e.g. very high process temperatures or very high-viscosity fluids).
- For gas applications with low pressure

 To achieve the highest possible measurement accuracy at low flow rates, the installation must protect the sensor from mechanical stresses during operation.

To get a representative zero point, ensure that:

- any flow in the device is prevented during the adjustment
- the process conditions (e.g. pressure, temperature) are stable and representative

Verification and adjustment cannot be carried out if the following process conditions are present:

- Gas pockets
 Ensure that the system has been sufficiently flushed with the medium. Repeat flushing can help to eliminate gas pockets
- Thermal circulation
 In the event of temperature differences (e.g. between the measuring tube inlet and outlet section), induced flow can occur even if the valves are closed due to thermal circulation in the device
- Leaks at the valves
 If the valves are not leak-tight, flow is not sufficiently prevented when determining the zero point

If these conditions cannot be avoided, it is advisable to keep the factory setting for the zero point.

Sensor holder

The sensor holder is used to secure the device to a wall, tabletop or pipe (order code for "Accessory enclosed", option PR).

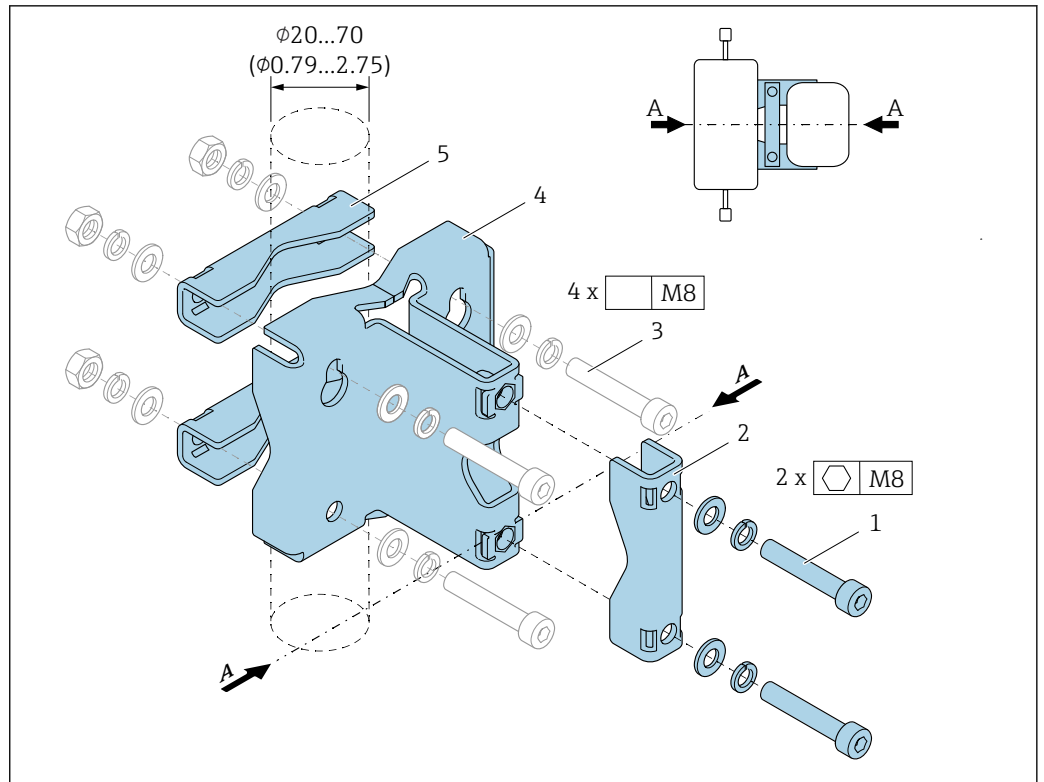

A0036471

- 1 2 x Allen screw M8 x 50, washer and spring washer A4
- 2 1 x clamp (measuring instrument neck)
- 3 4 x securing screw for wall, tabletop or pipe mounting (not supplied)
- 4 1 x base profile
- 5 2 x clamp (pipe mounting)
- A Measuring instrument central line

If the holder is used with a measuring instrument fitted with a rupture disk, it is important to ensure that the rupture disk in the neck is not covered over and that the cover of the rupture disk is not damaged.

⚠ WARNING

Strain on pipes!

Excessive strain on an unsupported pipe can cause the pipe to break.

- ▶ Install the sensor in a sufficiently supported pipe. In addition to the use of the sensor holder, for maximum mechanical stability the sensor can also be supported on the inlet and outlet sides onsite at the installation location with the use of pipe clamps, for example.

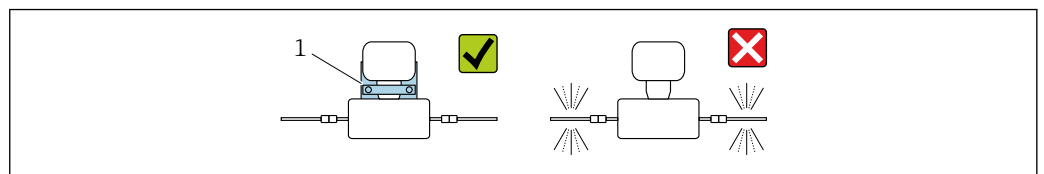

A0036492

- 1 Sensor holder (Order code for "Accessories enclosed", option PR)

The following mounting versions are recommended for the installation:

- i** Lubricate all threaded joints prior to mounting. The screws for wall, tabletop or pipe mounting are not supplied with the device and must be chosen to suit the individual installation position.

Wall mounting

Screw the sensor holder to the wall with four screws. Two of the four holes to secure the holder are designed to hook into the screws.

Mounting on a table

Screw the sensor holder onto the tabletop with four screws.

Pipe mounting

Secure the sensor holder to the pipe with two clamps.

⚠ WARNING

Failure to comply with the specifications for vibration and shock resistance can damage the measuring instrument!

- ▶ During operation, transportation and storage, ensure compliance with the specifications for maximum vibration and shock resistance →  244.

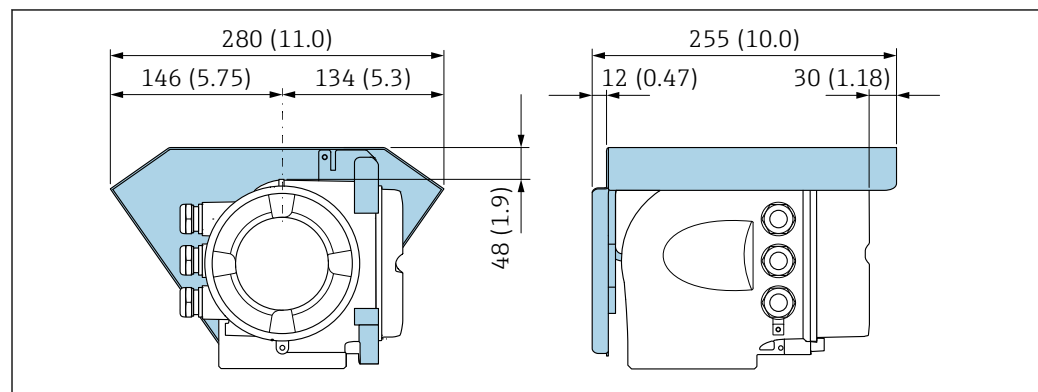
Weather protection cover

 6 Engineering unit mm (in)

6.2 Mounting the measuring instrument

6.2.1 Required tools

For sensor

For flanges and other process connections: Use a suitable mounting tool.

6.2.2 Preparing the measuring instrument

1. Remove all remaining transport packaging.
2. Remove any protective covers or protective caps present from the sensor.
3. Remove stick-on label on the electronics compartment cover.

6.2.3 Mounting the measuring device

⚠ WARNING

Danger due to improper process sealing!

- ▶ Ensure that the inside diameters of the gaskets are greater than or equal to that of the process connections and piping.
- ▶ Ensure that the seals are clean and undamaged.
- ▶ Secure the seals correctly.

1. Ensure that the direction of the arrow on the nameplate of the sensor matches the flow direction of the medium.
2. Install the measuring device or turn the transmitter housing so that the cable entries do not point upwards.

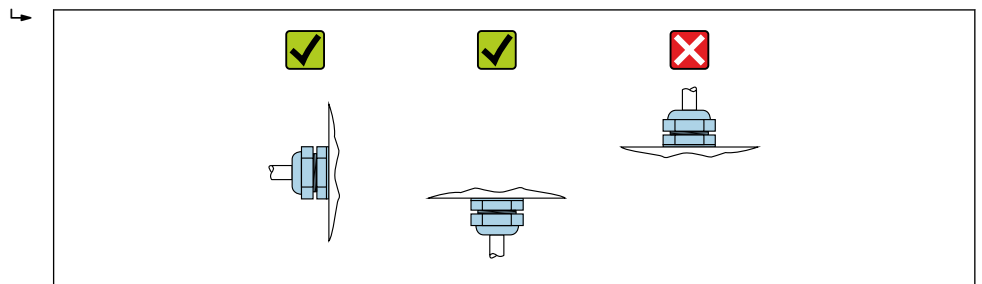

A0029263

6.2.4 Turning the transmitter housing

To provide easier access to the connection compartment or display module, the transmitter housing can be turned.

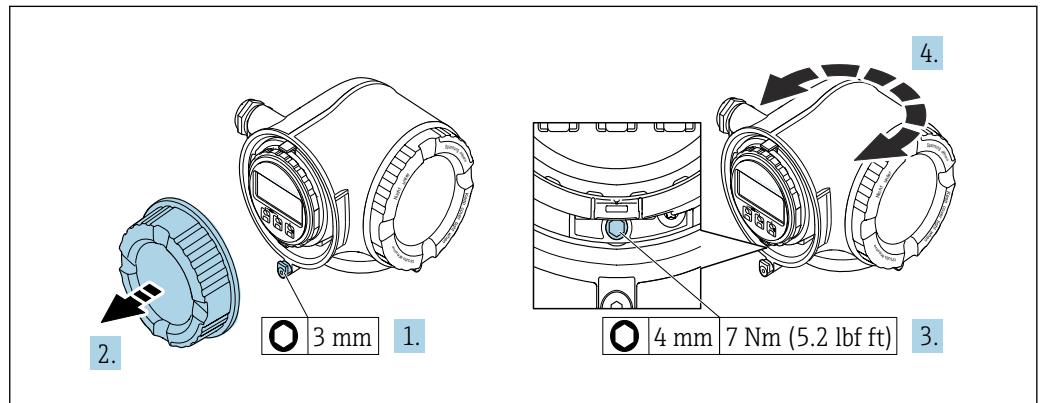

A0029993

7 Housing in non-Ex version

1. Depending on the device version: Loosen the securing clamp of the connection compartment cover.
2. Unscrew the connection compartment cover.
3. Loosen the fixing screw.
4. Turn the housing to the desired position.
5. Tighten the securing screw.
6. Screw on the connection compartment cover.
7. Depending on the device version: Attach the securing clamp of the connection compartment cover.

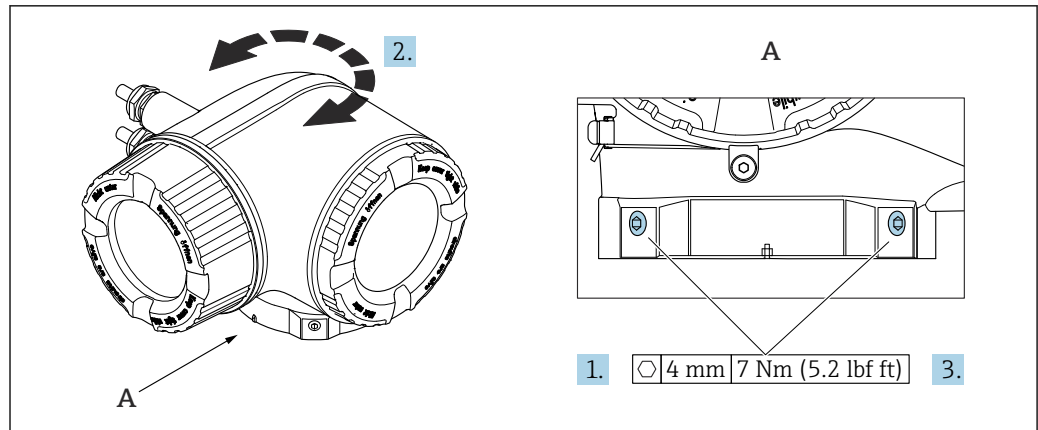

8 Ex housing

1. Loosen the fixing screws.
2. Turn the housing to the desired position.
3. Tighten the securing screws.

6.2.5 Turning the display module

The display module can be turned to optimize display readability and operability.

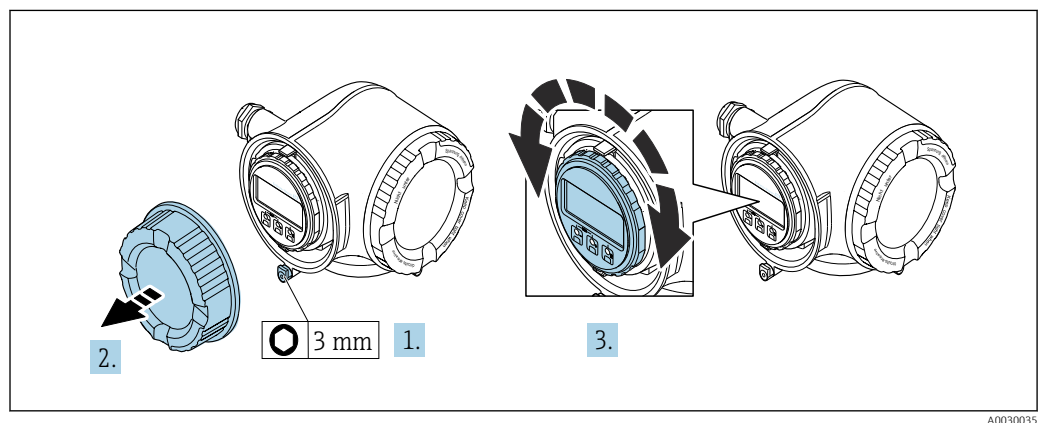

1. Depending on the device version: Loosen the securing clamp of the connection compartment cover.
2. Unscrew the connection compartment cover.
3. Turn the display module to the desired position: max. $8 \times 45^\circ$ in each direction.
4. Screw on the connection compartment cover.
5. Depending on the device version: Attach the securing clamp of the connection compartment cover.

6.3 Post-installation check

Is the device undamaged (visual inspection)?	<input type="checkbox"/>
Does the measuring instrument correspond to the measuring point specifications? For example: <ul style="list-style-type: none"> ▪ Process temperature → 245 ▪ Pressure (refer to the "Pressure-temperature ratings" section of the "Technical Information" document). ▪ Ambient temperature ▪ Measuring range 	<input type="checkbox"/>
Has the correct orientation for the sensor been selected → 22? <ul style="list-style-type: none"> ▪ According to sensor type ▪ According to medium temperature ▪ According to medium properties (outgassing, with entrained solids) 	<input type="checkbox"/>
Does the arrow on the sensor match the direction of flow of the medium? → 22?	<input type="checkbox"/>
Is the tag name and labeling correct (visual inspection)?	<input type="checkbox"/>
Is the device sufficiently protected from precipitation and direct sunlight?	<input type="checkbox"/>
Are the securing screw and securing clamp tightened securely?	<input type="checkbox"/>

7 Electrical connection

WARNING

Live parts! Incorrect work performed on the electrical connections can result in an electric shock.

- ▶ Set up a disconnecting device (switch or power-circuit breaker) to easily disconnect the device from the supply voltage.
- ▶ In addition to the device fuse, include an overcurrent protection unit with max. 10 A in the plant installation.

7.1 Electrical safety

In accordance with applicable national regulations.

7.2 Connecting requirements

7.2.1 Required tools

- For cable entries: Use corresponding tools
- For securing clamp: Allen key 3 mm
- Wire stripper
- When using stranded cables: Crimper for wire end ferrule
- For removing cables from terminal: Flat blade screwdriver ≤ 3 mm (0.12 in)

7.2.2 Requirements for connection cable

The connecting cables provided by the customer must fulfill the following requirements.

Protective grounding cable for the outer ground terminal

Conductor cross-section < 2.1 mm² (14 AWG)

The use of a cable lug enables the connection of larger cross-sections.

The grounding impedance must be less than 2 Ω .

Permitted temperature range

- The installation guidelines that apply in the country of installation must be observed.
- The cables must be suitable for the minimum and maximum temperatures to be expected.

Power supply cable (incl. conductor for the inner ground terminal)

Standard installation cable is sufficient.

Signal cable

-  For custody transfer, all signal lines must be shielded cables (tinned copper braiding, optical coverage ≥ 85 %). The cable shield must be connected on both sides.

PROFINET

Only PROFINET cables.

-  See <https://www.profibus.com> "PROFINET Planning guideline".

Ethernet-APL

Shielded twisted-pair cable. Cable type A is recommended.



See <https://www.profibus.com> Ethernet-APL White Paper "

Current output 0 /4 to 20 mA (excluding HART)

Standard installation cable is sufficient.

Pulse /frequency /switch output

Standard installation cable is sufficient.

Relay output

Standard installation cable is sufficient.

Current input 4 to 20 mA

Standard installation cable is sufficient.

Status input

Standard installation cable is sufficient.

Cable diameter

- Cable glands supplied:
M20 × 1.5 with cable Ø 6 to 12 mm (0.24 to 0.47 in)
- Spring-loaded terminals: Suitable for strands and strands with ferrules.
Conductor cross-section 0.2 to 2.5 mm² (24 to 12 AWG).

Requirements for connecting cable – remote display and operating module DKX001*Optionally available connecting cable*

A cable is supplied depending on the order option

- Order code for measuring device: order code **030** for "Display; operation", option **O** or
- Order code for measuring device: order code **030** for "Display; operation", option **M** and
- Order code for DKX001: order code **040** for "Cable", option **A, B, D, E**

Standard cable	2 × 2 × 0.34 mm ² (22 AWG) PVC cable with common shield (2 pairs, pair-stranded)
Flame resistance	According to DIN EN 60332-1-2
Oil resistance	According to DIN EN 60811-2-1
Shield	Tin-plated copper braid, optical cover ≥ 85 %
Capacitance: core/shield	≤ 200 pF/m
L/R	≤ 24 µH/Ω
Available cable length	5 m (15 ft)/10 m (35 ft)/20 m (65 ft)/30 m (100 ft)
Operating temperature	When mounted in a fixed position: -50 to +105 °C (-58 to +221 °F); when cable can move freely: -25 to +105 °C (-13 to +221 °F)

Standard cable - customer-specific cable

With the following order option, no cable is supplied with the device and must be provided by the customer:

Order code for DKX001: Order code **040** for "Cable", option **1** "None, provided by customer, max 300 m"

A standard cable with the following minimum requirements can be used as the connecting cable, even in the hazardous area (Zone 2, Class I, Division 2 and Zone 1, Class I, Division 1):



Standard cable	4 wires (2 pairs); pair-stranded with common shield, minimum wire cross-section 0.34 mm ² (22 AWG)
Shield	Tin-plated copper braid, optical cover \geq 85 %
Cable impedance (pair)	Minimum 80 Ω
Cable length	Maximum 300 m (1 000 ft), maximum loop impedance 20 Ω
Capacitance: core/shield	Maximum 1 000 nF for Zone 1, Class I, Division 1
L/R	Maximum 24 μ H/ Ω for Zone 1, Class I, Division 1

7.2.3 Terminal assignment

Transmitter: supply voltage, input/outputs

The terminal assignment of the inputs and outputs depends on the individual order version of the device. The device-specific terminal assignment is documented on an adhesive label in the terminal cover.

Supply voltage		Input/output 1	Input/output 2		Input/output 3	
1 (+)	2 (-)	PROFINET (RJ45 connector)	24 (+)	25 (-)	22 (+)	23 (-)
Device-specific terminal assignment: adhesive label in terminal cover.						

 Terminal assignment of the remote display and operating module →  41.

7.2.4 Available device plugs

 Device plugs may not be used in hazardous areas!

Order code for "Input; output 1", option RA "PROFINET"

Order code for "Electrical connection"	Cable entry/connection	
	2	3
L, N, P, U	Connector M12 × 1	-
R ^{1) 2)} , S ^{1) 2)} , T ^{1) 2)} , V ^{1) 2)}	Connector M12 × 1	Connector M12 × 1

- 1) Cannot be combined with an external WLAN antenna (order code for "Enclosed accessories", option P8) of an RJ45 M12 adapter for the service interface (order code for "Accessories mounted", option NB) or of the remote display and operating module DKX001.
- 2) Suitable for integrating the device in a ring topology.

7.2.5 device plug pin assignment

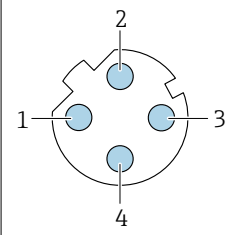
 <p style="text-align: right; font-size: small;">A0032047</p>	Pin	Assignment	
	1	+	TD +
	2	+	RD +
	3	-	TD -
	4	-	RD -
	Coding		Plug/socket
D		Socket	

7.2.6 Preparing the measuring device

NOTICE

Insufficient sealing of the housing!

Operational reliability of the measuring device could be compromised.

- ▶ Use suitable cable glands corresponding to the degree of protection.

1. Remove dummy plug if present.

2. If the measuring device is supplied without cable glands:
Provide suitable cable gland for corresponding connecting cable.
3. If the measuring device is supplied with cable glands:
Observe requirements for connecting cables →  32.

7.3 Connecting the measuring instrument

NOTICE

An incorrect connection compromises electrical safety!

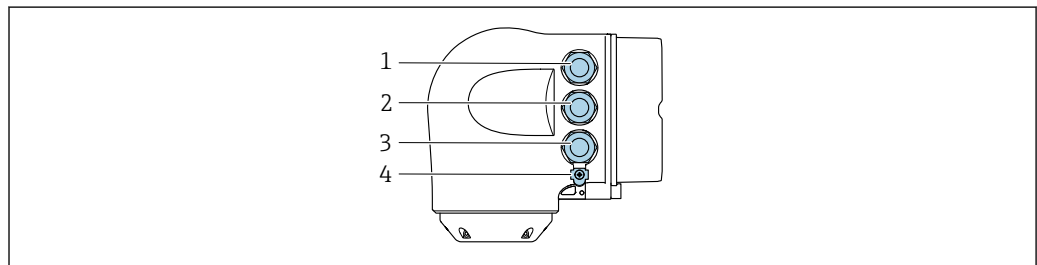

- ▶ Only properly trained specialist staff may perform electrical connection work.
- ▶ Observe applicable federal/national installation codes and regulations.
- ▶ Comply with local workplace safety regulations.
- ▶ Always connect the protective ground cable ⊕ before connecting additional cables.
- ▶ When using in potentially explosive atmospheres, observe the information in the device-specific Ex documentation.

7.3.1 Connecting the transmitter



A0026781

- 1 Terminal connection for supply voltage
- 2 Terminal connection for signal transmission, input/output
- 3 Terminal connection for signal transmission, input/output or terminal connection for network connection via service interface (CDI-RJ45); optional: connection for external WLAN antenna or remote display and operating module DKX001
- 4 Protective earth (PE)

-  In addition to connecting the device via PROFINET with Ethernet-APL and the available inputs/outputs, an additional connection option is also available:
Integrate into a network via the service interface (CDI-RJ45) →  39.

Connecting PROFINET with Ethernet-APL connector

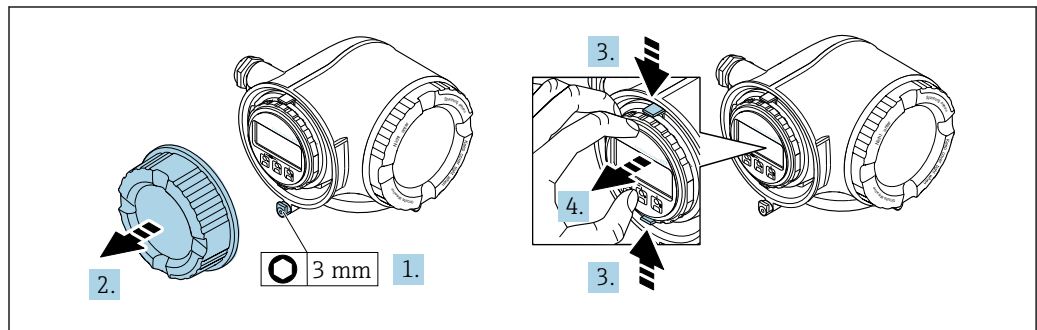

A0029813

1. Loosen the securing clamp of the connection compartment cover.
2. Unscrew the connection compartment cover.
3. Squeeze the tabs of the display module holder together.
4. Remove the display module holder.

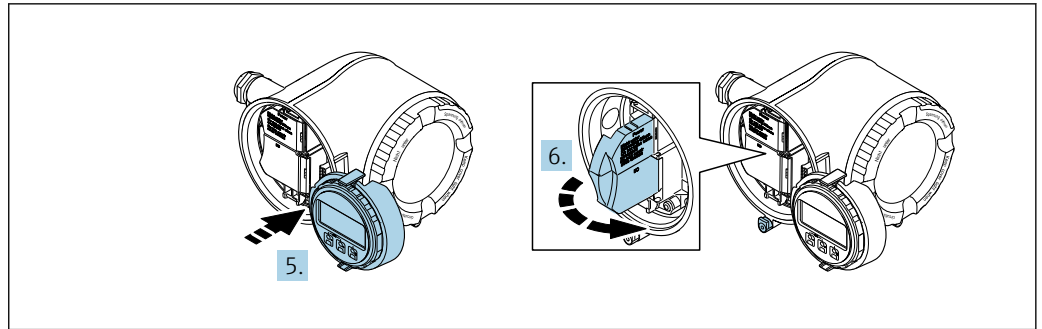

A0029814

- 5. Attach the holder to the edge of the electronics compartment.
- 6. Open the terminal cover.

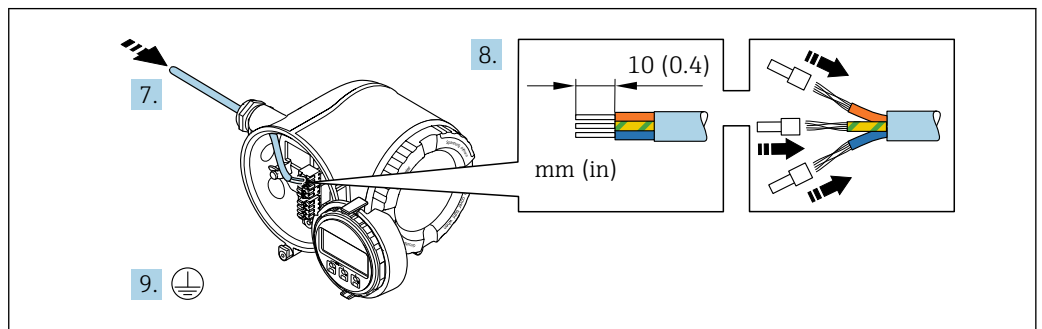

A0029815

- 7. Push the cable through the cable entry. To ensure tight sealing, do not remove the sealing ring from the cable entry.
- 8. Strip the cable and cable ends and connect to terminals 26-27. In the case of stranded cables, also fit ferrules.
- 9. Connect protective earth (PE).
- 10. Firmly tighten the cable glands.
 - ↳ This concludes the connection via the APL port.

Connecting the supply voltage and additional inputs/outputs

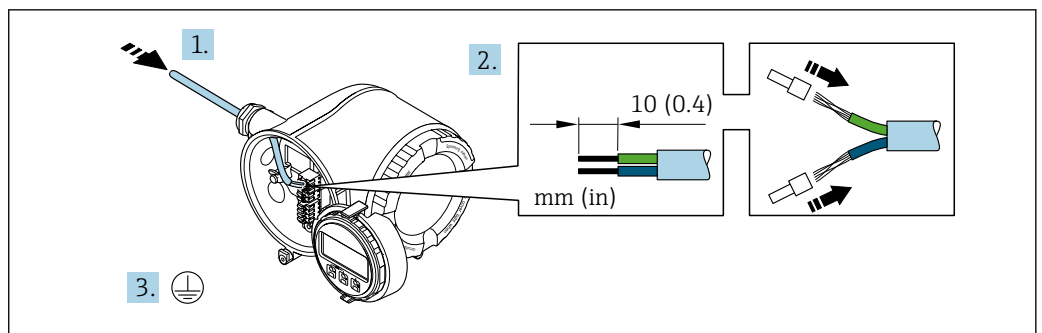

A003983

- 1. Push the cable through the cable entry. To ensure tight sealing, do not remove the sealing ring from the cable entry.
- 2. Strip the cable and cable ends. In the case of stranded cables, also fit ferrules.
- 3. Connect the protective ground.

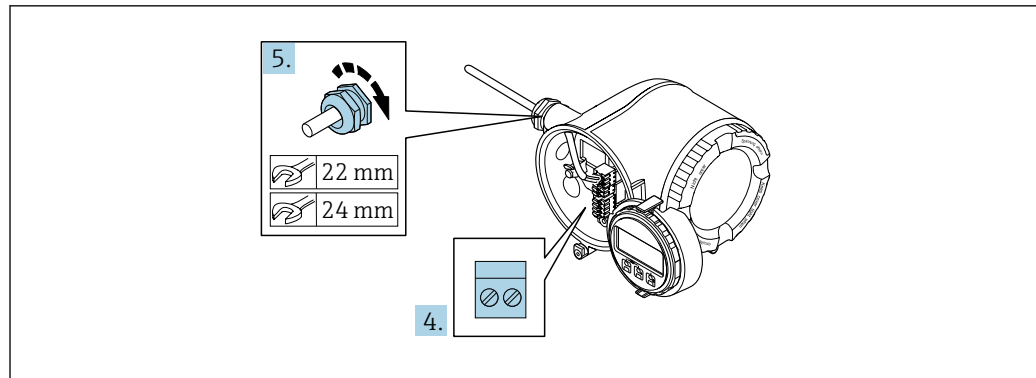

A0033984

4. Connect the cable according to the terminal assignment.
 - ↳ **Signal cable terminal assignment:** The device-specific terminal assignment is documented on an adhesive label in the terminal cover.
 - Supply voltage terminal assignment:** Adhesive label in the terminal cover or → 35.
5. Firmly tighten the cable glands.
 - ↳ This concludes the cable connection process.
6. Close the terminal cover.
7. Fit the display module holder in the electronics compartment.
8. Screw on the connection compartment cover.
9. Secure the securing clamp of the connection compartment cover.

Removing a cable

To remove a cable from the terminal:

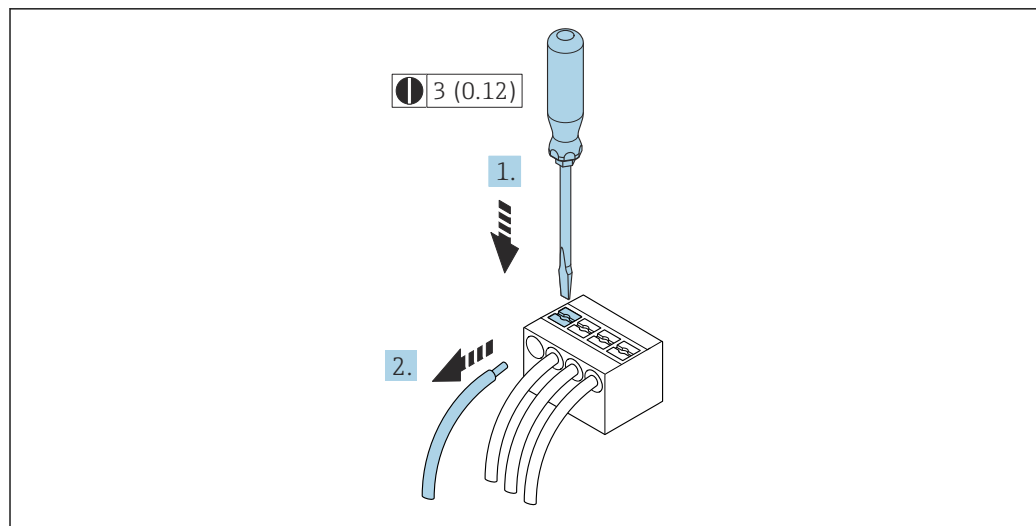

A0029598

9 Engineering unit mm (in)

1. Use a flat-blade screwdriver to press down on the slot between the two terminal holes.
2. Remove the cable end from the terminal.

7.3.2 Integrating the transmitter into a network

This section only presents the basic options for integrating the device into a network.

For information on the procedure to follow to connect the transmitter correctly →  36.

Integrating via the service interface

The device is integrated via the connection to the service interface (CDI-RJ45).

Note the following when connecting:

- Recommended cable: CAT 5e, CAT 6 or CAT 7, with shielded connector (e.g. brand: YAMAICHI ; Part No Y-ConProfixPlug63 / Prod. ID: 82-006660)
- Maximum cable thickness: 6 mm
- Length of plug including anti-bend protection: 42 mm
- Bending radius: 5 x cable thickness

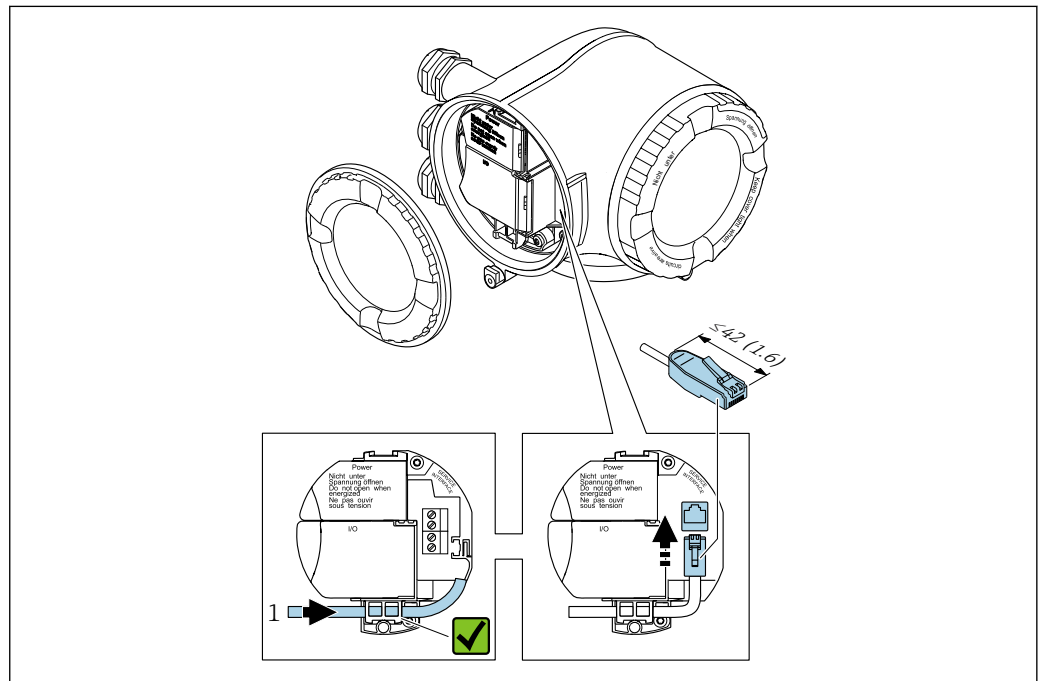

1 Service interface (CDI-RJ45)

-  An adapter for the RJ45 to the M12 plug is optionally available:
Order code for "Accessories", option **NB**: "Adapter RJ45 M12 (service interface)"

The adapter connects the service interface (CDI-RJ45) to an M12 plug mounted in the cable entry. The connection to the service interface can thus be established via an M12 plug without opening the device.

Integrating into a ring topology

The device is integrated via the terminal connection for signal transmission (output 1) and the connection to the service interface (CDI-RJ45).

Note the following when connecting:

- Recommended cable: CAT5e, CAT6 or CAT7, with shielded connector (e.g. brand: YAMAICHI ; Part No Y-ConProfixPlug63 / Prod. ID: 82-006660)
- Maximum cable thickness: 6 mm
- Length of plug including anti-bend protection: 42 mm
- Bending radius: 2.5 x cable thickness

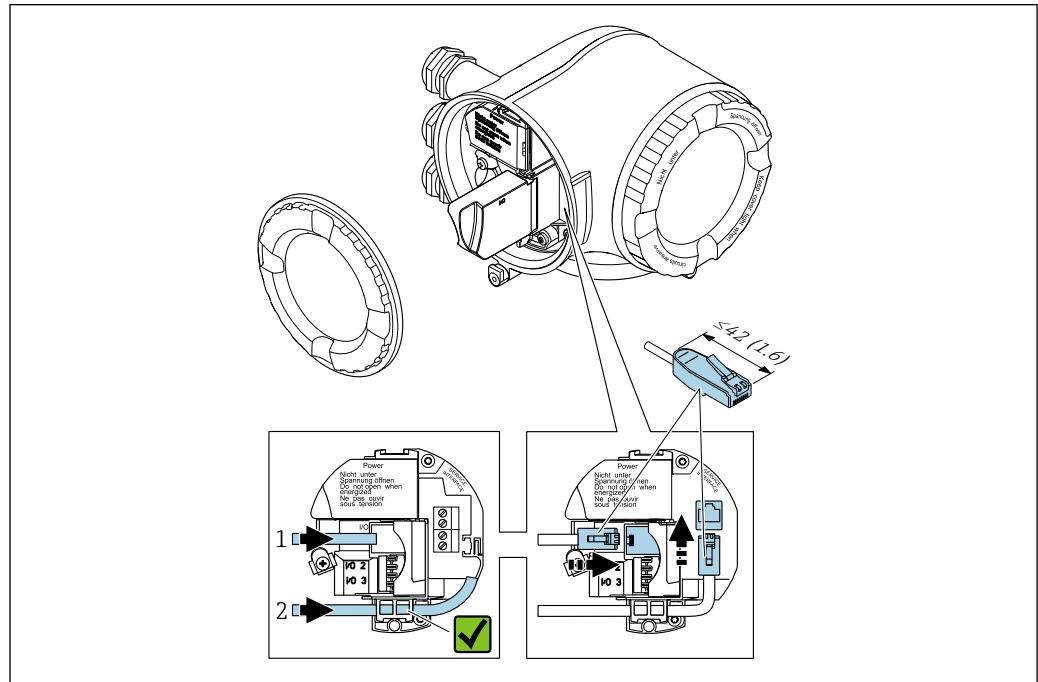

A0033717

- 1 PROFINET connection
- 2 Service interface (CDI-RJ45)

i An adapter for the RJ45 to the M12 plug is optionally available:
Order code for "Accessories", option **NB**: "Adapter RJ45 M12 (service interface)"

The adapter connects the service interface (CDI-RJ45) to an M12 plug mounted in the cable entry. The connection to the service interface can thus be established via an M12 plug without opening the device.

7.3.3 Connecting the remote display and operating module DKX001

i The remote display and operating module DKX001 is available as an optional extra → 227..

- The remote display and operating module DKX001 is only available for the following housing version: order code for "Housing": option A "Aluminum, coated"
- The measuring instrument is always supplied with a dummy cover when the remote display and operating module DKX001 is ordered directly with the measuring instrument. Display or operation at the transmitter is not possible in this case.
- If ordered subsequently, the remote display and operating module DKX001 may not be connected at the same time as the existing measuring instrument display module. Only one display or operation unit may be connected to the transmitter at any one time.

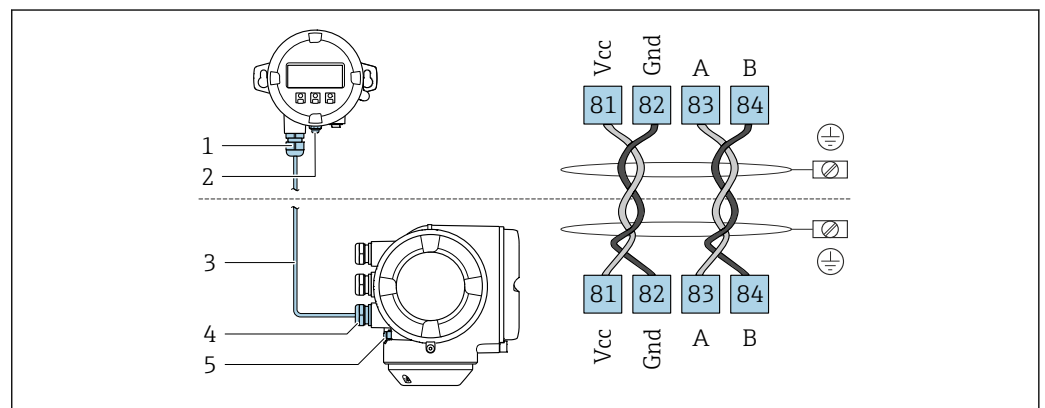

A0027518

- 1 Remote display and operating module DKX001
- 2 Terminal connection for potential equalization (PE)
- 3 Connecting cable
- 4 Measuring instrument
- 5 Terminal connection for potential equalization (PE)

7.4 Potential equalization

7.4.1 Requirements

For potential equalization:

- Pay attention to in-house grounding concepts
- Take account of operating conditions, such as the pipe material and grounding
- Connect the medium, sensor and transmitter to the same electric potential
- Use a ground cable with a minimum cross-section of 6 mm² (10 AWG) and a cable lug for potential equalization connections

7.5 Special connection instructions

7.5.1 Connection examples

PROFINET

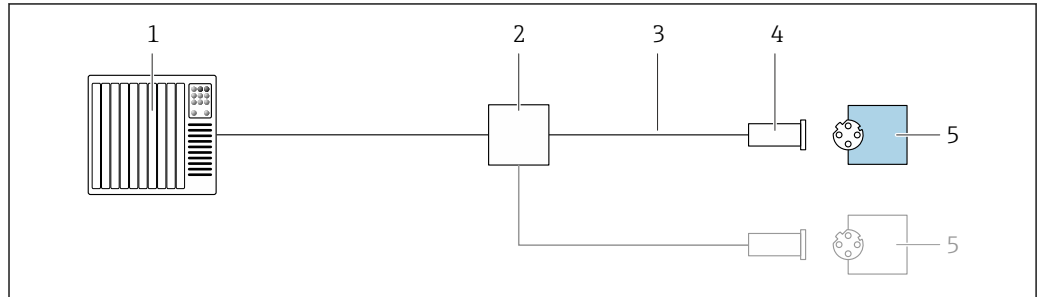

A0028767

 10 Connection example for PROFINET

- 1 Control system (e.g. PLC)
- 2 Ethernet switch
- 3 Observe cable specifications
- 4 Device plug
- 5 Transmitter

PROFINET: MRP (Media Redundancy Protocol)

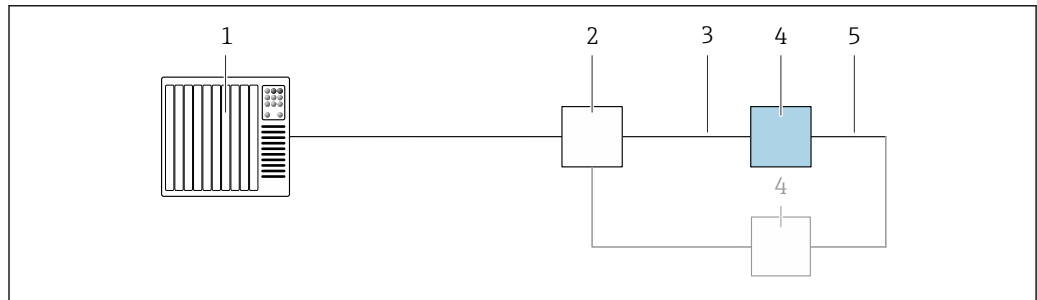

A0027544

- 1 Control system (e.g. PLC)
- 2 Ethernet switch
- 3 Observe cable specifications →  32
- 4 Transmitter
- 5 Connecting cable between the two transmitters

PROFINET: system redundancy S2

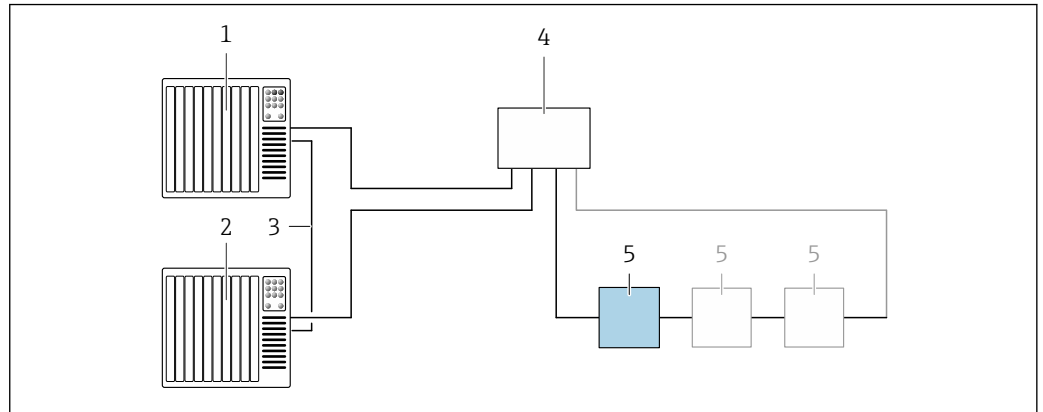

A0039553

11 Connection example for system redundancy S2

- 1 Control system 1 (e.g. PLC)
- 2 Synchronization of control systems
- 3 Control system 2 (e.g. PLC)
- 4 Industrial Ethernet Managed Switch
- 5 Transmitter

Current output 4-20 mA

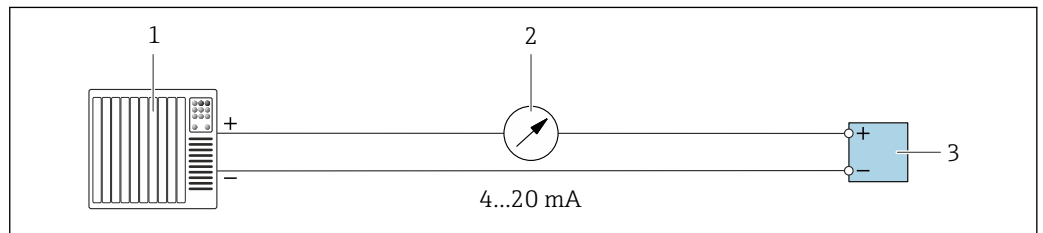

A0028758

12 Connection example for 4-20 mA current output (active)

- 1 Automation system with current input (e.g. PLC)
- 2 Analog display unit: observe maximum load
- 3 Transmitter

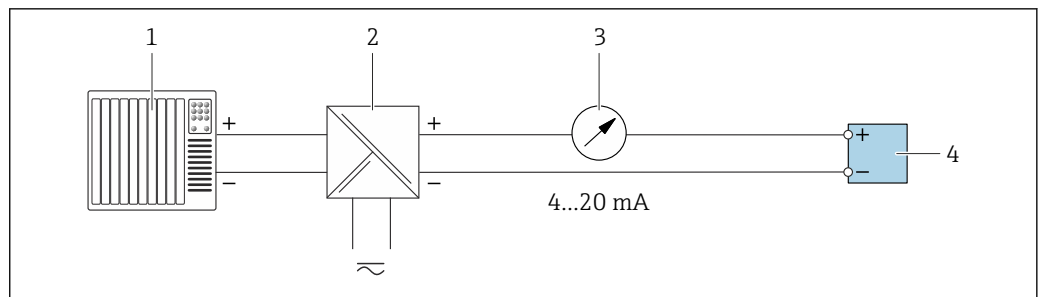

A0028759

13 Connection example for 4-20 mA current output (passive)

- 1 Automation system with current input (e.g. PLC)
- 2 Active barrier for power supply (e.g. RN221N)
- 3 Analog display unit: observe maximum load
- 4 Transmitter

Pulse/frequency output

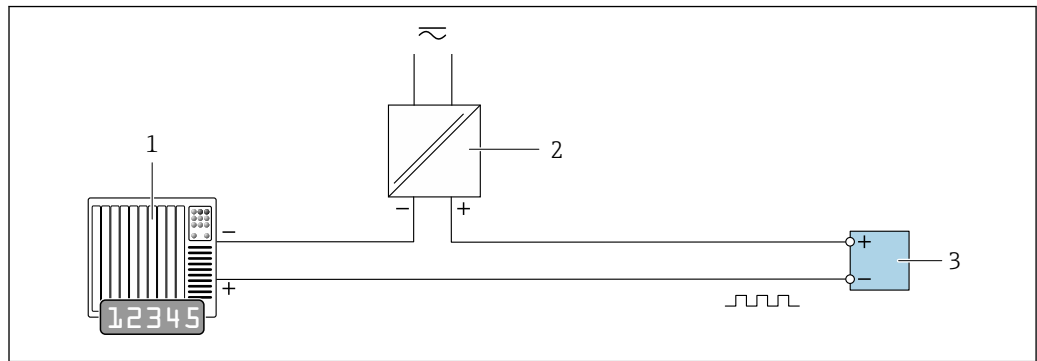

A0028761

14 Connection example for pulse/frequency output (passive)

- 1 Automation system with pulse/frequency input (e.g. PLC with 10 k Ω pull-up or pull-down resistor)
- 2 Power supply
- 3 Transmitter: observe input values → 233

Switch output

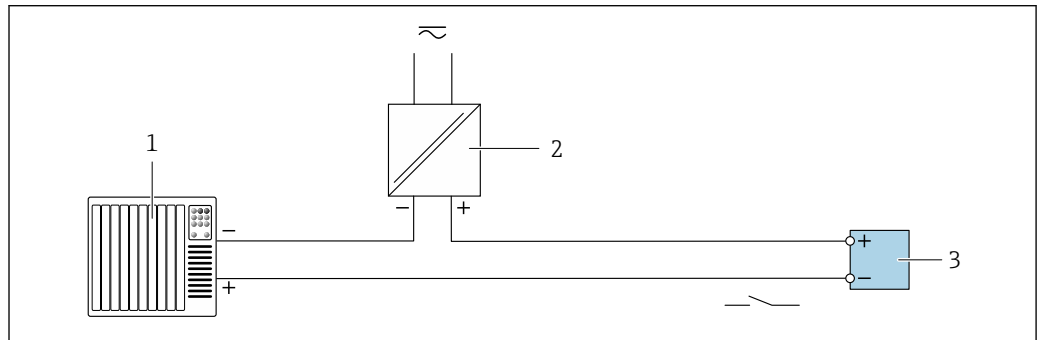

A0028760

15 Connection example for switch output (passive)

- 1 Automation system with switch input (e.g. PLC with a 10 k Ω pull-up or pull-down resistor)
- 2 Power supply
- 3 Transmitter: observe input values → 233

Relay output

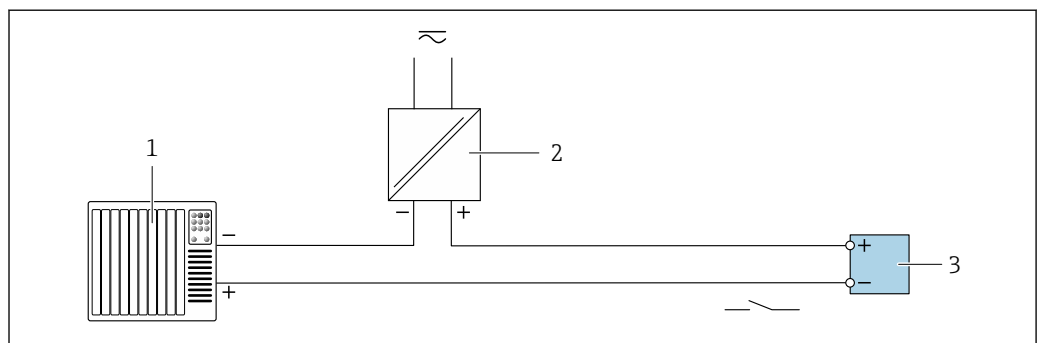

A0028760

16 Connection example for relay output (passive)

- 1 Automation system with relay input (e.g. PLC)
- 2 Power supply
- 3 Transmitter: observe input values → 235

Current input

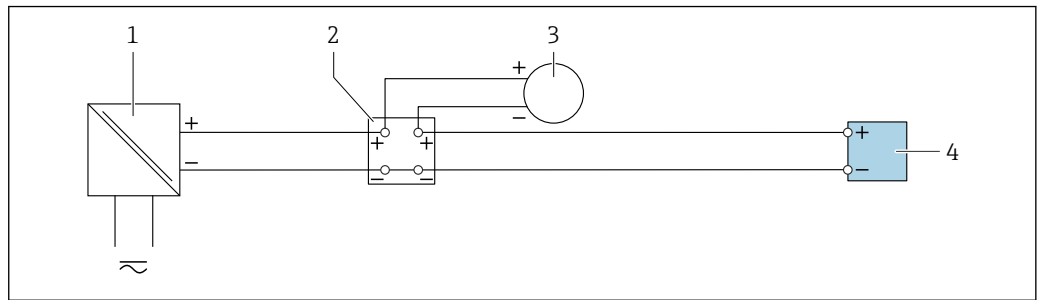

A0028915

17 Connection example for 4 to 20 mA current input

- 1 Power supply
- 2 Terminal box
- 3 External measuring device (to read in pressure or temperature, for instance)
- 4 Transmitter

Status input

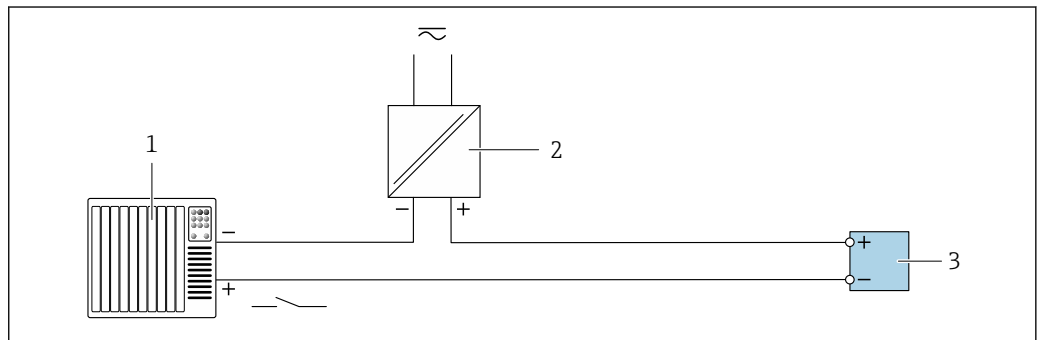

A0028764

18 Connection example for status input

- 1 Automation system with status output (e.g. PLC)
- 2 Power supply
- 3 Transmitter

7.6 Hardware settings

7.6.1 Setting the device name

A measuring point can be quickly identified within a plant on the basis of the tag name. The tag name is equivalent to the device name (name of station of the PROFINET specification). The factory-assigned device name can be changed using the DIP switches or the automation system.

Example of device name (factory setting): EH-Promass300-XXXX

EH	Endress+Hauser
Promass	Instrument family
300	Transmitter
XXXX	Serial number of the device

The device name currently used is displayed in Setup → Name of station is also displayed.

Setting the device name using the DIP switches

The last part of the device name can be set using DIP switches 1-8. The address range is between 1 and 254 (factory setting: serial number of the device)

Overview of the DIP switches

DIP switch	Bit	Description
1	128	Configurable part of the device name
2	64	
3	32	
4	16	
5	8	
6	4	
7	2	
8	1	

Example: Setting the device name EH-PROMASS300-065

DIP switch	ON/OFF	Bit	Device name
1	OFF	-	EH-PROMASS300-065
2	ON	64	
3...7	OFF	-	
8	ON	1	
Serial number of the device:		065	

Setting the device name

Risk of electric shock when opening the transmitter housing.

- ▶ Before opening the transmitter housing:
- ▶ Disconnect the device from the power supply.

i The default IP address may **not** be activated → 47.

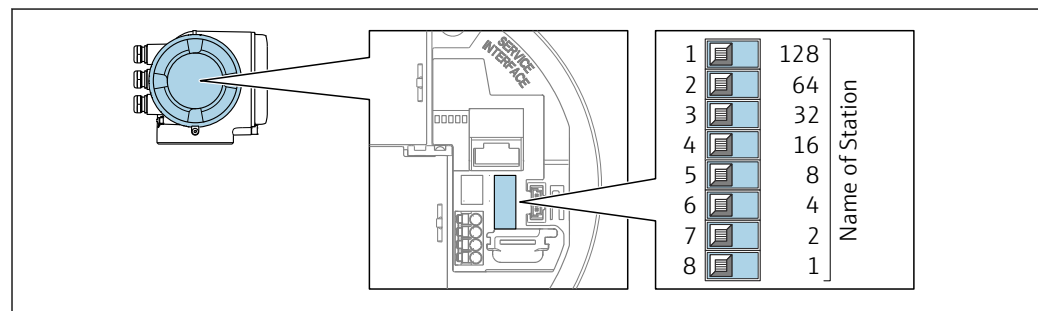

1. Depending on the housing version, loosen the securing clamp or fixing screw of the housing cover.
2. Depending on the housing version, unscrew or open the housing cover and disconnect the local display from the main electronics module where necessary .
3. Set the desired device name using the corresponding DIP switches on the I/O electronics module.
4. Reverse the removal procedure to reassemble the transmitter.

5. Reconnect the device to the power supply.
 - ↳ The configured device address is used once the device is restarted.

Setting the device name via the automation system

DIP switches 1-8 must all be set to **OFF** (factory setting) or all be set to **ON** to be able to set the device name via the automation system.

The complete device name (name of station) can be changed individually via the automation system.

- i** The serial number used as part of the device name in the factory setting is not saved. It is not possible to reset the device name to the factory setting with the serial number. The value "0" is used instead of the serial number.
- When assigning the device name via the automation system:
 - assign the device name in lower case letters.

7.6.2 Activating the default IP address

Activating the default IP address by DIP switch

Risk of electric shock when opening the transmitter housing.

- ▶ Before opening the transmitter housing:
- ▶ Disconnect the device from the power supply.

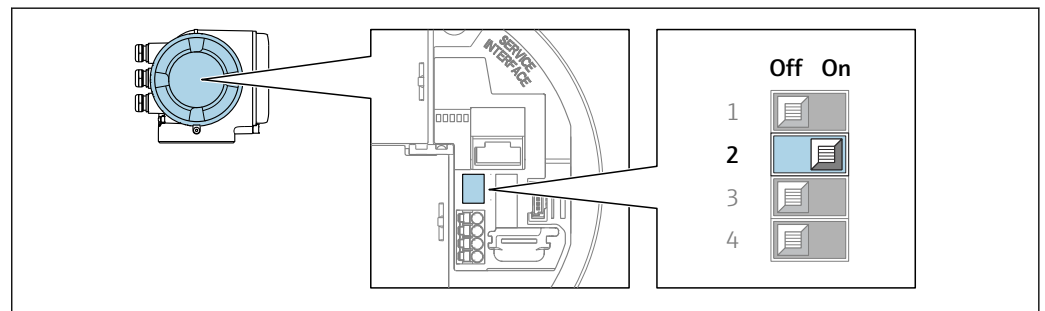

1. Depending on the housing version, loosen the securing clamp or fixing screw of the housing cover.
2. Depending on the housing version, unscrew or open the housing cover and disconnect the local display from the main electronics module where necessary .
3. Set DIP switch no. 2 on the I/O electronics module from **OFF** → **ON**.
4. Reassemble the transmitter in the reverse order.
5. Reconnect the device to the power supply.
 - ↳ The default IP address is used once the device is restarted.

7.7 Ensuring the degree of protection

The measuring instrument fulfills all the requirements for the degree of protection IP66/67, Type 4X enclosure.

To guarantee the degree of protection IP66/67, Type 4X enclosure, carry out the following steps after the electrical connection:

1. Check that the housing seals are clean and fitted correctly.
2. Dry, clean or replace the seals if necessary.
3. Tighten all housing screws and screw covers.
4. Firmly tighten the cable glands.

5. To ensure that moisture does not enter the cable entry:
Route the cable so that it loops down before the cable entry ("water trap").

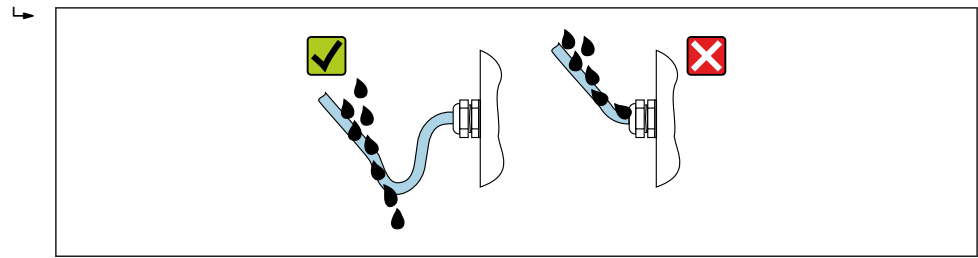

A0029278

6. The cable glands supplied do not ensure housing protection when not in use. They must therefore be replaced by dummy plugs corresponding to the housing protection.

7.8 Post-connection check

Are the device and cable undamaged (visual inspection)?	<input type="checkbox"/>
Is the protective earthing established correctly?	<input type="checkbox"/>
Do the cables used comply with the requirements ?	<input type="checkbox"/>
Are the installed cables strain-relieved and securely routed?	<input type="checkbox"/>
Are all cable glands installed, securely tightened and leak-tight? Cable run with "water trap" → 47?	<input type="checkbox"/>
Is the terminal assignment correct ?	<input type="checkbox"/>
If supply voltage is present: Does an indication appear on the display module?	<input type="checkbox"/>
Are dummy plugs inserted in unused cable entries and have transportation plugs been replaced with dummy plugs?	<input type="checkbox"/>

8 Operation options

8.1 Overview of operation options

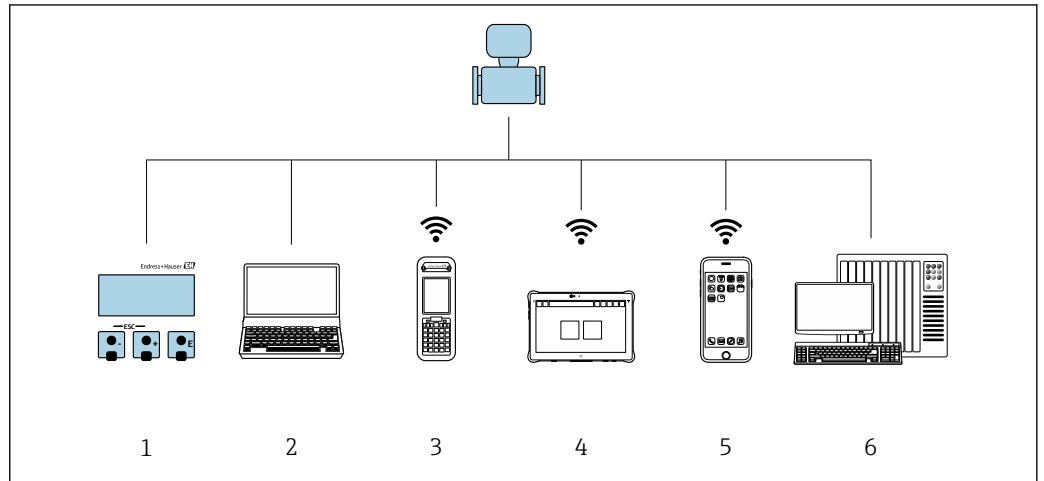

A0034513

- 1 Local operation via display module
- 2 Computer with web browser or operating tool (e.g. FieldCare, DeviceCare, AMS Device Manager, SIMATIC PDM)
- 3 Field Xpert SFX350 or SFX370
- 4 Field Xpert SMT70
- 5 Mobile handheld terminal
- 6 Automation system (e.g. PLC)

8.2 Structure and function of the operating menu

8.2.1 Structure of the operating menu

 For an overview of the operating menu for experts: see the "Description of Device Parameters" document supplied with the device

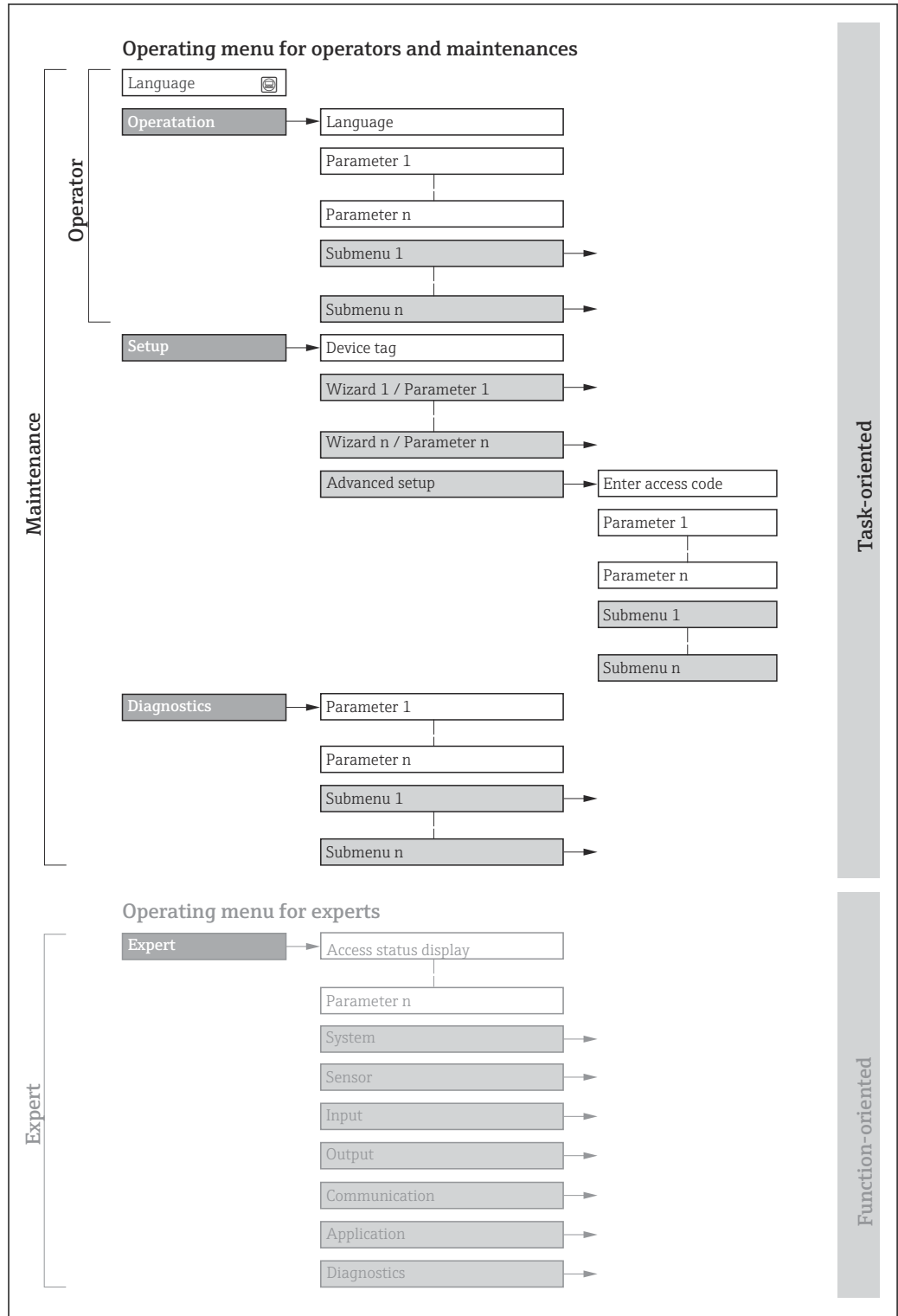

 19 Schematic structure of the operating menu

A0018237-EN

8.2.2 Operating philosophy

The individual parts of the operating menu are assigned to certain user roles (e.g. operator, maintenance etc.). Each user role contains typical tasks within the device life cycle.

Menu/parameter		User role and tasks	Content/meaning
Language	Task-oriented	Role "Operator", "Maintenance" Tasks during operation: <ul style="list-style-type: none"> ▪ Configuration of the operational display ▪ Reading measured values 	<ul style="list-style-type: none"> ▪ Defining the operating language ▪ Defining the Web server operating language ▪ Resetting and controlling totalizers
Operation			<ul style="list-style-type: none"> ▪ Configuration of the operational display (e.g. display format, display contrast) ▪ Resetting and controlling totalizers
Setup		"Maintenance" role Commissioning: <ul style="list-style-type: none"> ▪ Configuration of the measurement ▪ Configuration of the inputs and outputs ▪ Configuration of the communication interface 	Wizards for fast commissioning: <ul style="list-style-type: none"> ▪ Configuring the system units ▪ Configuration of the communication interface ▪ Definition of the medium ▪ Displaying the I/O configuration ▪ Configuring the inputs ▪ Configuring the outputs ▪ Configuration of the operational display ▪ Configuring the low flow cut off ▪ Configuring partial and empty pipe detection Advanced setup <ul style="list-style-type: none"> ▪ For more customized configuration of the measurement (adaptation to special measuring conditions) ▪ Configuration of totalizers ▪ Configuration of WLAN settings ▪ Administration (define access code, reset measuring device)
Diagnostics		"Maintenance" role Troubleshooting: <ul style="list-style-type: none"> ▪ Diagnostics and elimination of process and device errors ▪ Measured value simulation 	Contains all parameters for error detection and analyzing process and device errors: <ul style="list-style-type: none"> ▪ Diagnostic list Contains up to 5 currently pending diagnostic messages. ▪ Event logbook Contains event messages that have occurred. ▪ Device information Contains information for identifying the device ▪ Measured values Contains all current measured values. ▪ Data logging submenu with the "Extended HistoROM" order option Storage and visualization of measured values ▪ Heartbeat Technology Verification of device functionality on request and documentation of verification results ▪ Simulation Used to simulate measured values or output values.

Menu/parameter	User role and tasks	Content/meaning
Expert	Function-oriented	<p>Tasks that require detailed knowledge of the function of the device:</p> <ul style="list-style-type: none"> ▪ Commissioning measurements under difficult conditions ▪ Optimal adaptation of the measurement to difficult conditions ▪ Detailed configuration of the communication interface ▪ Error diagnostics in difficult cases <p>Contains all of the device parameters and allows direct access to these by means of an access code. The structure of this menu is based on the function blocks of the device:</p> <ul style="list-style-type: none"> ▪ System Contains all higher-level device parameters that do not affect measurement or measured value communication ▪ Sensor Configuration of the measurement. ▪ Input Configuration of the status input ▪ Output Configuration of the analog current outputs as well as the pulse/frequency and switch output ▪ Communication Configuration of the digital communication interface and the Web server ▪ Application Configuration of the functions that go beyond the actual measurement (e.g. totalizer) ▪ Diagnostics Error detection and analysis of process and device errors and for device simulation and Heartbeat Technology.

8.3 Access to operating menu via local display

8.3.1 Operational display

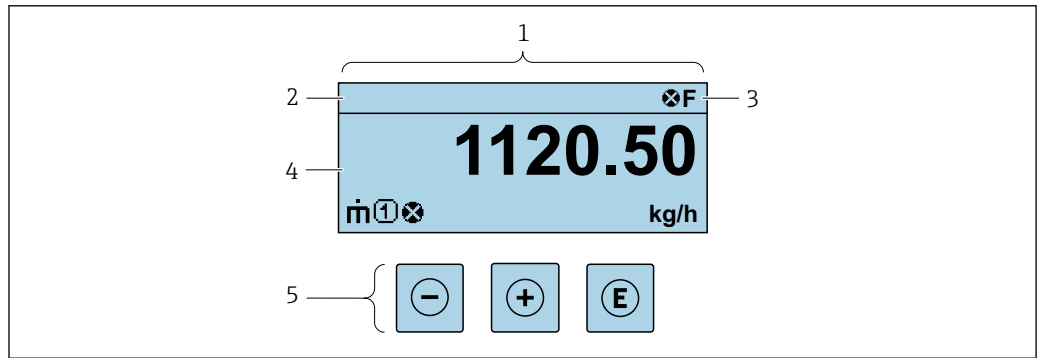

- 1 Operational display
- 2 Device tag
- 3 Status area
- 4 Display range for measured values (up to 4 lines)
- 5 Operating elements → 58

Status area

The following symbols appear in the status area of the operational display at the top right:

- Status signals → 159
 - F: Failure
 - C: Function check
 - S: Out of specification
 - M: Maintenance required
- Diagnostic behavior → 160
 - ⊗: Alarm
 - ⚠: Warning
 - 🔒: Locking (the device is locked via the hardware)
 - ↔: Communication (communication via remote operation is active)

Display area

In the display area, each measured value is prefaced by certain symbol types for further description:

Measured variables

Symbol	Meaning
	Mass flow
	<ul style="list-style-type: none"> Volume flow Corrected volume flow
	<ul style="list-style-type: none"> Density Reference density
	Temperature

The number and display format of the measured variables can be configured via the **Format display** parameter (→ 113).

Totalizer

Symbol	Meaning
	Totalizer The measurement channel number indicates which of the three totalizers is displayed.

Input

Symbol	Meaning
	Status input

Measurement channel numbers

Symbol	Meaning
	Measurement channel 1 to 4 The measurement channel number is displayed only if more than one channel is present for the same measured variable type (e.g. totalizer 1 to 3).

Diagnostic behavior

Symbol	Meaning
	Alarm <ul style="list-style-type: none"> Measurement is interrupted. Signal outputs and totalizers assume the defined alarm condition. A diagnostic message is generated.
	Warning <ul style="list-style-type: none"> Measurement is resumed. The signal outputs and totalizers are not affected. A diagnostic message is generated.

The diagnostic behavior pertains to a diagnostic event that is relevant to the displayed measured variable.

8.3.2 Navigation view

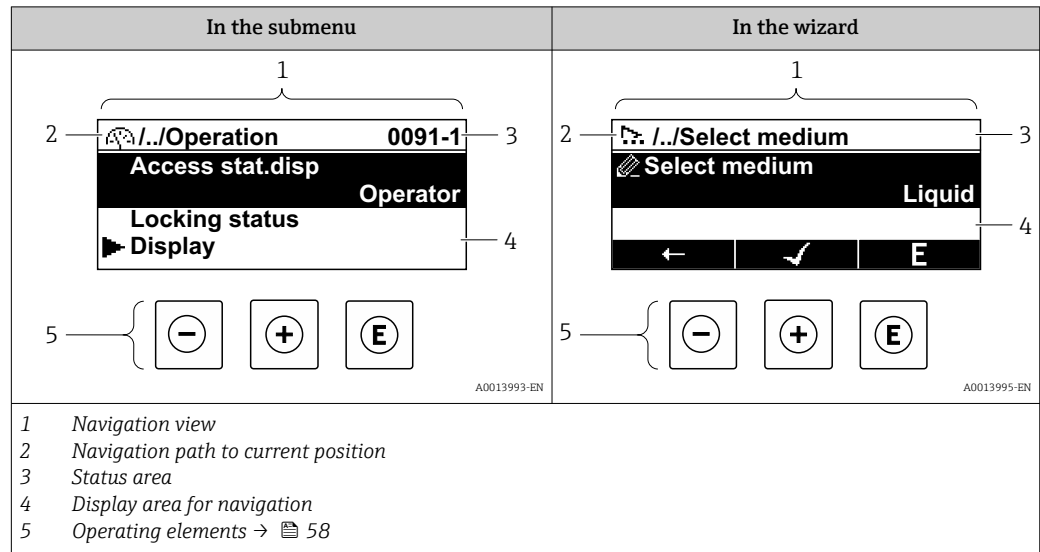

Navigation path

The navigation path to the current position is displayed at the top left in the navigation view and consists of the following elements:

- The display symbol for the menu/submenu (▶) or the wizard (🔍).
- An omission symbol (/../) for operating menu levels in between.
- Name of the current submenu, wizard or parameter

	Display symbol	Omission symbol	Parameter
	↓	↓	↓
Example	▶	/ ../	Indication

For more information about the icons in the menu, refer to the "Display area" section → 54

Status area

The following appears in the status area of the navigation view in the top right corner:



- In the submenu
 - The direct access code to the parameter (e.g., 0022-1)
 - If a diagnostic event is present, the diagnostic behavior and status signal
- In the wizard
 - If a diagnostic event is present, the diagnostic behavior and status signal

- For information on the diagnostic behavior and status signal → 159
- For information on the function and entry of the direct access code → 60





Display area

Menus

Symbol	Meaning
	<p>Operation Is displayed:</p> <ul style="list-style-type: none"> ▪ In the menu next to the "Operation" selection ▪ At the left in the navigation path in the Operation menu

	<p>Setup Is displayed:</p> <ul style="list-style-type: none"> ▪ In the menu next to the "Setup" selection ▪ At the left in the navigation path in the Setup menu
	<p>Diagnosis Is displayed:</p> <ul style="list-style-type: none"> ▪ In the menu next to the "Diagnostics" selection ▪ At the left in the navigation path in the Diagnostics menu
	<p>Expert Is displayed:</p> <ul style="list-style-type: none"> ▪ In the menu next to the "Expert" selection ▪ At the left in the navigation path in the Expert menu



Submenus, wizards, parameters

Symbol	Meaning
	Submenu
	Wizards
	Parameters within a wizard  No display symbol exists for parameters in submenus.

Locking procedure

Symbol	Meaning
	<p>Parameter locked When displayed in front of a parameter name, indicates that the parameter is locked.</p> <ul style="list-style-type: none"> ▪ By a user-specific access code ▪ By the hardware write protection switch

Wizards

Symbol	Meaning
	Switches to the previous parameter.
	Confirms the parameter value and switches to the next parameter.
	Opens the editing view of the parameter.

8.3.3 Editing view

Numeric editor

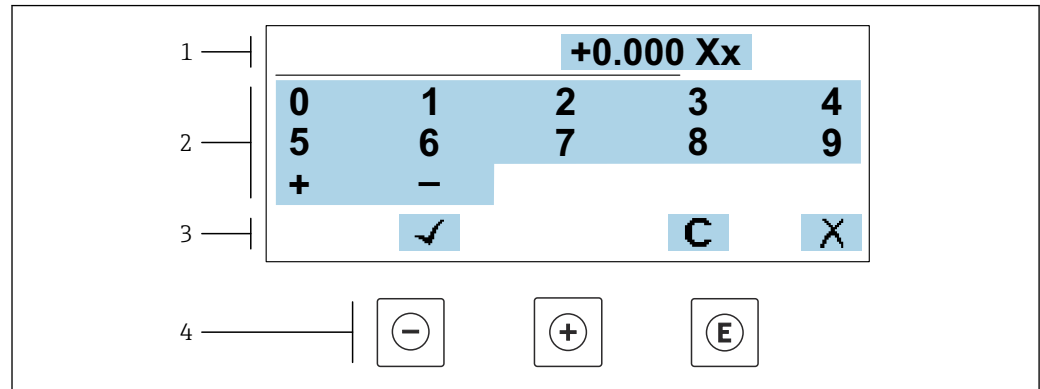

A0034250

20 For entering values in parameters (e.g. limit values)

- 1 Entry display area
- 2 Input screen
- 3 Confirm, delete or reject entry
- 4 Operating elements

Text editor

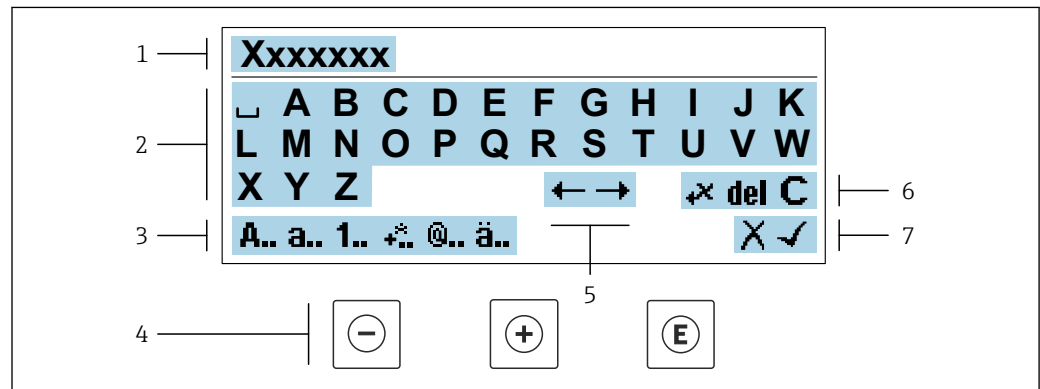

A0034114

21 For entering text in parameters (e.g. device tag)

- 1 Entry display area
- 2 Current input screen
- 3 Change input screen
- 4 Operating elements
- 5 Move entry position
- 6 Delete entry
- 7 Reject or confirm entry

Using the operating elements in the editing view



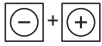

Operating key	Meaning
	Minus key Move the entry position to the left.
	Plus key Move the entry position to the right.

Operating key	Meaning
	Enter key <ul style="list-style-type: none"> Pressing the key briefly confirms your selection. Pressing the key for 2 s confirms your entry.
	Escape key combination (press keys simultaneously) Close the editing view without accepting a change.





Input screens

Symbol	Meaning
A..	Upper case
a..	Lower case
1..	Numbers
+..	Punctuation marks and special characters: = + - * / ² ³ ¼ ½ ¾ () [] < > { }
@..	Punctuation marks and special characters: " ' ^ . , ; : ? ! % μ ° € \$ £ ¥ § @ # / \ ~ & _
ä..	Umlauts and accents

Controlling data entries

Symbol	Meaning
	Move entry position
	Reject entry
	Confirm entry
	Delete character immediately to the left of the entry position
del	Delete character immediately to the right of the entry position
C	Clear all the characters entered

8.3.4 Operating elements

Operating key	Meaning
	<p>Minus key</p> <p><i>In menu, submenu</i> Moves the selection bar upwards in a picklist</p> <p><i>In wizards</i> Goes to previous parameter</p> <p><i>In the text and numeric editor</i> Move the entry position to the left.</p>
	<p>Plus key</p> <p><i>In menu, submenu</i> Moves the selection bar downwards in a picklist</p> <p><i>In wizards</i> Goes to the next parameter</p> <p><i>In the text and numeric editor</i> Move the entry position to the right.</p>
	<p>Enter key</p> <p><i>In the operational display</i> Pressing the key briefly opens the operating menu.</p> <p><i>In menu, submenu</i></p> <ul style="list-style-type: none"> ▪ Pressing the key briefly: <ul style="list-style-type: none"> ▪ Opens the selected menu, submenu or parameter. ▪ Starts the wizard. ▪ If help text is open, closes the help text of the parameter. ▪ Pressing the key for 2 s in a parameter: <ul style="list-style-type: none"> ▪ If present, opens the help text for the function of the parameter. <p><i>In wizards</i> Opens the editing view of the parameter and confirms the parameter value</p> <p><i>In the text and numeric editor</i></p> <ul style="list-style-type: none"> ▪ Pressing the key briefly confirms your selection. ▪ Pressing the key for 2 s confirms your entry.
	<p>Escape key combination (press keys simultaneously)</p> <p><i>In menu, submenu</i></p> <ul style="list-style-type: none"> ▪ Pressing the key briefly: <ul style="list-style-type: none"> ▪ Exits the current menu level and takes you to the next higher level. ▪ If help text is open, closes the help text of the parameter. ▪ Pressing the key for 2 s returns you to the operational display ("home position"). <p><i>In wizards</i> Exits the wizard and takes you to the next higher level</p> <p><i>In the text and numeric editor</i> Exits the Editing view without applying the changes.</p>
	<p>Minus/Enter key combination (press and hold down the keys simultaneously)</p> <ul style="list-style-type: none"> ▪ If keypad lock is active: <ul style="list-style-type: none"> ▪ Pressing the key for 3 s deactivates the keypad lock. ▪ If keypad lock is not active: <ul style="list-style-type: none"> ▪ Pressing the key for 3 s opens the context menu including the option for activating the keypad lock.



8.3.5 Opening the context menu

Using the context menu, the user can call up the following menus quickly and directly from the operational display:

- Setup
- Data backup
- Simulation



Calling up and closing the context menu

The user is in the operational display.

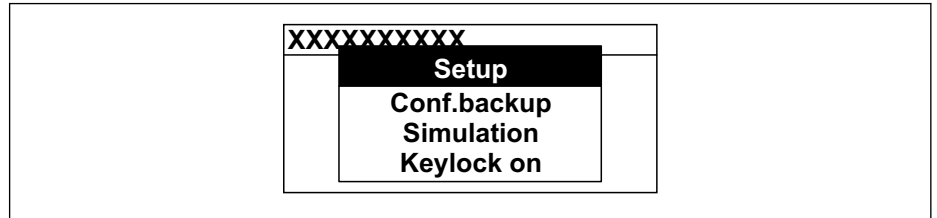

1. Press the  and  keys for longer than 3 seconds.
 - ↳ The context menu opens.



A0034608-EN

2. Press  +  simultaneously.
 - ↳ The context menu is closed and the operational display appears.

Calling up the menu via the context menu

1. Open the context menu.
2. Press  to navigate to the desired menu.
3. Press  to confirm the selection.
 - ↳ The selected menu opens.

8.3.6 Navigating and selecting from list

Different operating elements are used to navigate through the operating menu. The navigation path is displayed on the left in the header. Icons are displayed in front of the individual menus. These icons are also shown in the header during navigation.

i For an explanation of the navigation view with symbols and operating elements → 54

Example: Setting the number of displayed measured values to "2 values"

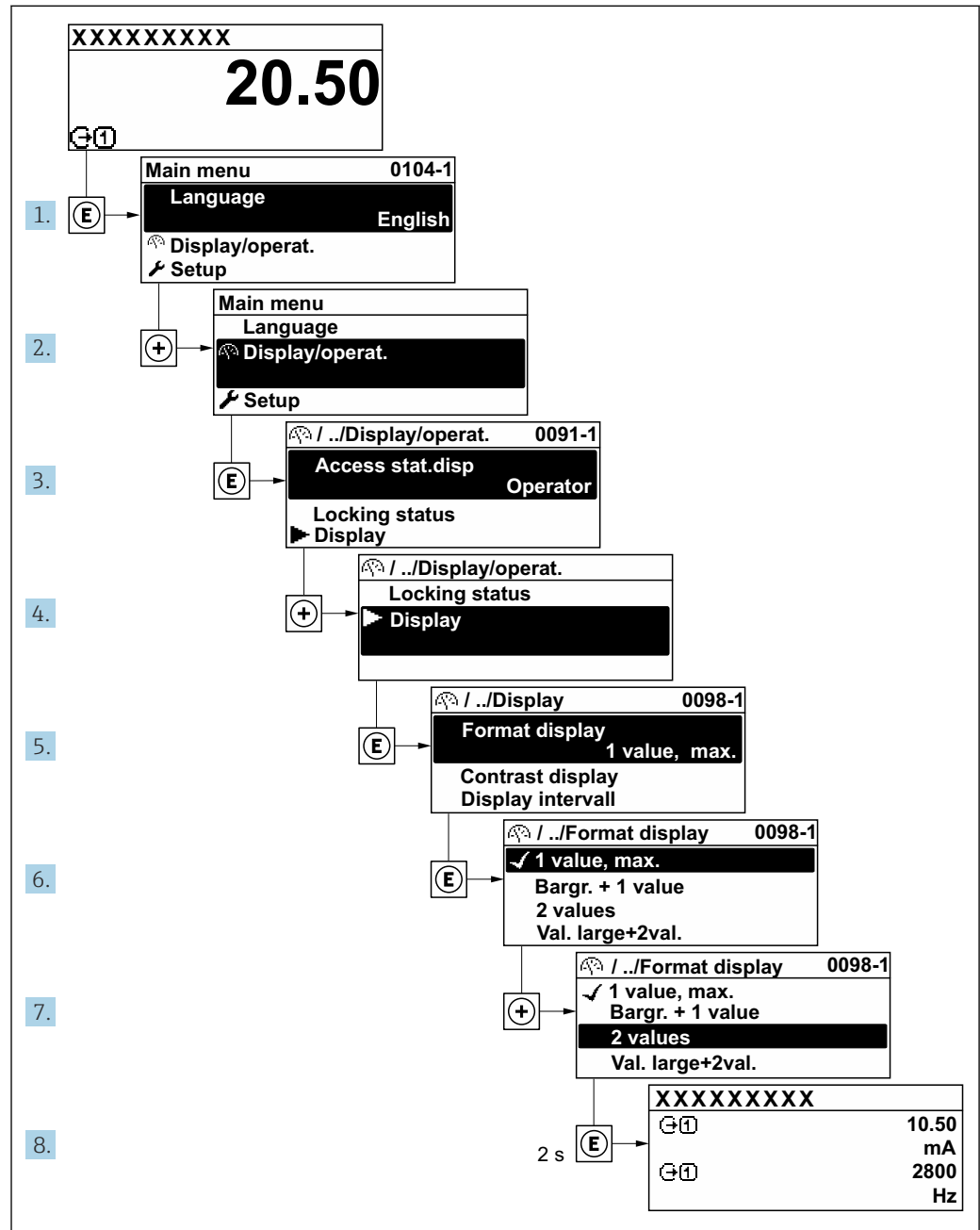

A0029562-EN

8.3.7 Calling the parameter directly

A parameter number is assigned to every parameter to be able to access a parameter directly via the onsite display. Entering this access code in the **Direct access** parameter calls up the desired parameter directly.

Navigation path

Expert → Direct access

The direct access code consists of a 5-digit number (at maximum) and the channel number, which identifies the channel of a process variable: e.g. 00914-2. In the navigation view, this appears on the right-hand side in the header of the selected parameter.

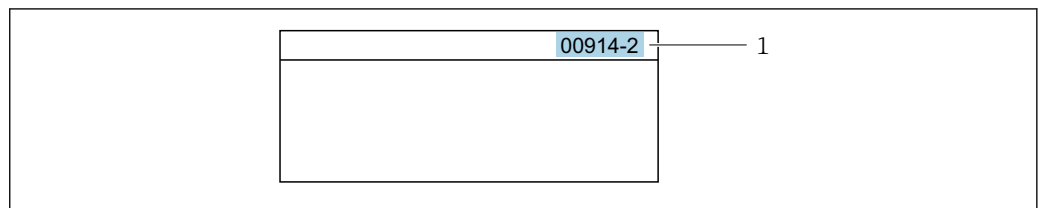

A0029414

1 Direct access code

Note the following when entering the direct access code:

- The leading zeros in the direct access code do not have to be entered.
Example: Enter "914" instead of "00914"
- If no channel number is entered, channel 1 is opened automatically.
Example: Enter 00914 → **Assign process variable** parameter
- If a different channel is opened: Enter the direct access code with the corresponding channel number.
Example: Enter 00914-2 → **Assign process variable** parameter



For the direct access codes of the individual parameters, see the "Description of Device Parameters" document for the device

8.3.8 Calling up help text

Help text is available for some parameters and can be called up from the navigation view. The help text provides a brief explanation of the parameter function and thereby supports swift and safe commissioning.

Calling up and closing the help text

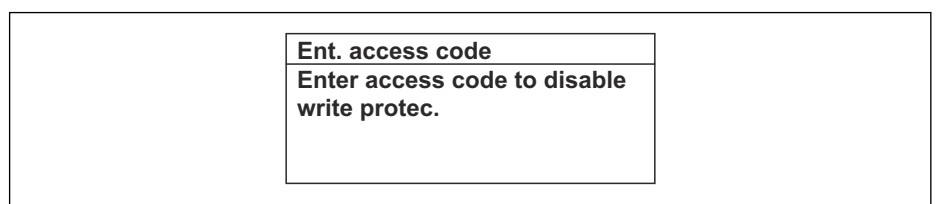

The user is in the navigation view and the selection bar is on a parameter.

1. Press  for 2 s.
 - ↳ The help text for the selected parameter opens.



A0014002-EN

 22 Example: Help text for parameter "Enter access code"

2. Press  +  simultaneously.
 - ↳ The help text is closed.

8.3.9 Changing the parameters

Parameters can be changed via the numeric editor or text editor.

- Numeric editor: Change values in a parameter, e.g. specifications for limit values.
- Text editor: Enter text in a parameter, e.g. tag name.

A message is displayed if the value entered is outside the permitted value range.

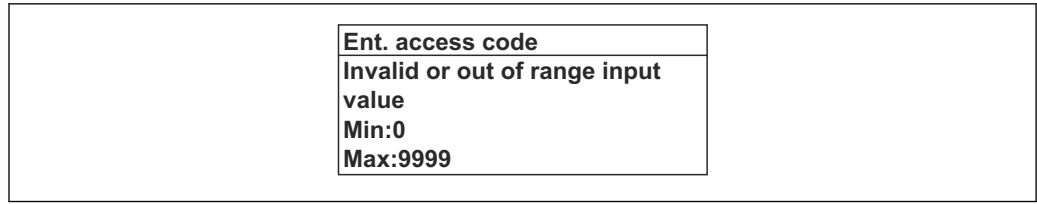

A0014049-EN

i For a description of the editing view - consisting of the text editor and numeric editor - with symbols → 56, for a description of the operating elements → 58

8.3.10 User roles and related access authorization

The two user roles "Operator" and "Maintenance" have different write access to the parameters if the customer defines a user-specific access code. This protects the device configuration via the local display from unauthorized access → 139.

Defining access authorization for user roles

An access code is not yet defined when the device is delivered from the factory. Access authorization (read and write access) to the device is not restricted and corresponds to the "Maintenance" user role.

- ▶ Define the access code.
 - ↳ The "Operator" user role is redefined in addition to the "Maintenance" user role. Access authorization differs for the two user roles.

Access authorization to parameters: "Maintenance" user role

Access code status	Read access	Write access
An access code has not yet been defined (factory setting).	✓	✓
After an access code has been defined.	✓	✓ ¹⁾

1) The user only has write access after entering the access code.

Access authorization to parameters: "Operator" user role

Access code status	Read access	Write access
After an access code has been defined.	✓	- ¹⁾

1) Despite the defined access code, certain parameters can always be modified and thus are excluded from the write protection as they do not affect the measurement: write protection via access code → 139

i The user role with which the user is currently logged on is indicated by the **Access status** parameter. Navigation path: Operation → Access status

8.3.11 Disabling write protection via access code

If the -symbol appears on the local display in front of a parameter, the parameter is write-protected by a user-specific access code and its value cannot be changed at the moment using local operation → 139.

Parameter write protection via local operation can be disabled by entering the user-specific access code in the **Enter access code** parameter (→ 118) via the respective access option.

1. After you press , the input prompt for the access code appears.

2. Enter the access code.
 - ↳ The -symbol in front of the parameters disappears; all previously write-protected parameters are now re-enabled.

8.3.12 Enabling and disabling the keypad lock



The keypad lock makes it possible to block access to the entire operating menu via local operation. As a result, it is no longer possible to navigate through the operating menu or change the values of individual parameters. Users can only read the measured values on the operational display.

The keypad lock is switched on and off via the context menu.

Switching on the keypad lock



-  The keypad lock is switched on automatically:
- If the device has not been operated via the display for > 1 minute.
 - Each time the device is restarted.

To activate the keylock manually:

1. The device is in the measured value display.
Press the  and  keys for 3 seconds.
 - ↳ A context menu appears.
2. In the context menu select the **Keylock on** option.
 - ↳ The keypad lock is switched on.

-  If the user attempts to access the operating menu while the keypad lock is active, the **Keylock on** message appears.

Switching off the keypad lock



- ▶ The keypad lock is switched on.
Press the  and  keys for 3 seconds.
 - ↳ The keypad lock is switched off.

8.4 Access to operating menu via web browser

8.4.1 Function range

With the integrated web server, the device can be operated and configured via a web browser and via the service interface (CDI-RJ45) or WLAN interface. The structure of the operating menu is the same as for the local display. In addition to the measured values, status information on the device is displayed and can be used to monitor device health. Furthermore the device data can be managed and the network parameters can be configured.

A device that has a WLAN interface (can be ordered as an option) is required for the WLAN connection: order code for "Display; operation", option G "4-line, illuminated; touch control + WLAN". The device acts as an Access Point and enables communication by computer or a mobile handheld terminal.

-  For additional information on the web server, see the Special Documentation for the device. →  259

8.4.2 Requirements

Computer hardware



Hardware	Interface	
	CDI-RJ45	WLAN
Interface	The computer must have a RJ45 interface. ¹⁾	The operating unit must have a WLAN interface.
Connection	Standard Ethernet cable	Connection via Wireless LAN.
Screen	Recommended size: ≥12" (depends on the screen resolution)	

- 1) Recommended cable: CAT5e, CAT6 or CAT7, with shielded plug (e.g. YAMAICHI product; part no. Y-ConProfixPlug63/Prod. ID: 82-006660)

Computer software



Software	Interface	
	CDI-RJ45	WLAN
Recommended operating systems	<ul style="list-style-type: none"> ▪ Microsoft Windows 8 or higher. ▪ Mobile operating systems: <ul style="list-style-type: none"> ▪ iOS ▪ Android <p> Microsoft Windows XP and Windows 7 is supported.</p>	
Web browsers supported	<ul style="list-style-type: none"> ▪ Microsoft Internet Explorer 8 or higher ▪ Microsoft Edge ▪ Mozilla Firefox ▪ Google Chrome ▪ Safari 	

Computer settings



Settings	Interface	
	CDI-RJ45	WLAN
User rights	Appropriate user rights (e.g. administrator rights) for TCP/IP and proxy server settings are necessary (e.g. for adjusting the IP address, subnet mask etc.).	
Proxy server settings of the web browser	The web browser setting <i>Use a proxy server for your LAN</i> must be disabled .	
JavaScript	JavaScript must be enabled.  If JavaScript cannot be enabled: Enter <code>http://192.168.1.212/servlet/basic.html</code> in the address bar of the web browser. A fully functional but simplified version of the operating menu structure starts in the web browser.  When installing a new firmware version: To enable correct data display, clear the temporary memory (cache) under Internet options in the web browser.	JavaScript must be enabled.  The WLAN display requires JavaScript support.
Network connections	Only use the active network connections to the measuring device.	
	Switch off all other network connections such as WLAN for example.	Switch off all other network connections.

 In the event of connection problems: →  156

Measuring device: Via CDI-RJ45 service interface

Device	CDI-RJ45 service interface
Measuring device	The measuring device has an RJ45 interface.
Web server	Web server must be enabled; factory setting: ON  For information on enabling the Web server →  69

Measuring device: via WLAN interface

Device	WLAN interface
Measuring device	The measuring device has a WLAN antenna: <ul style="list-style-type: none"> ▪ Transmitter with integrated WLAN antenna ▪ Transmitter with external WLAN antenna
Web server	Web server and WLAN must be enabled; factory setting: ON  For information on enabling the Web server →  69

8.4.3 Connecting the device

Via service interface (CDI-RJ45)

Preparing the measuring device

1. Depending on the housing version:
Loosen the securing clamp or fixing screw of the housing cover.
2. Depending on the housing version:
Unscrew or open the housing cover.
3. Connect the computer to the RJ45 plug via the standard Ethernet connecting cable..

Configuring the Internet protocol of the computer

The IP address can be assigned to the measuring device in a variety of ways:

- Dynamic Configuration Protocol (DCP), factory setting:
The IP address is automatically assigned to the measuring device by the automation system (e.g. Siemens S7).
- Hardware addressing:
The IP address is set via DIP switches .
- Software addressing:
The IP address is entered via the **IP address** parameter (→  90) .
- DIP switch for "Default IP address":
To establish the network connection via the service interface (CDI-RJ45): the fixed IP address 192.168.1.212 is used .

The device works with the Dynamic Configuration Protocol (DCP) ex-works, i.e. the IP address of the measuring device is automatically assigned by the automation system (e.g. Siemens S7).

To establish a network connection via the service interface (CDI-RJ45): set the "Default IP address" DIP switch to **ON**. The measuring device then has the fixed IP address: 192.168.1.212. The fixed IP address 192.168.1.212 can now be used to establish the connection to the network.

1. Via DIP switch 2, activate the default IP address 192.168.1.212: .
2. Switch on the measuring device.
3. Connect the computer to the RJ45 plug via the standard Ethernet cable →  71.

4. If a 2nd network card is not used, close all the applications on the notebook.
 - ↳ Applications requiring Internet or a network, such as e-mail, SAP applications, Internet or Windows Explorer.
5. Close any open Internet browsers.
6. Configure the properties of the Internet protocol (TCP/IP) as defined in the table:

IP address	192.168.1.XXX; for XXX all numerical sequences except: 0, 212 and 255 → e.g. 192.168.1.213
Subnet mask	255.255.255.0
Default gateway	192.168.1.212 or leave cells empty

Via WLAN interface

Configuring the Internet protocol of the mobile terminal

NOTICE

If the WLAN connection is lost during the configuration, settings made may be lost.

- ▶ Make sure that the WLAN connection is not disconnected while configuring the device.

NOTICE

Note the following to avoid a network conflict:

- ▶ Avoid accessing the measuring device simultaneously from the same mobile terminal via the service interface (CDI-RJ45) and the WLAN interface.
- ▶ Only activate one service interface (CDI-RJ45 or WLAN interface).
- ▶ If simultaneous communication is necessary: configure different IP address ranges, e.g. 192.168.0.1 (WLAN interface) and 192.168.1.212 (CDI-RJ45 service interface).

Preparing the mobile terminal

- ▶ Enable WLAN on the mobile terminal.

Establishing a WLAN connection from the mobile terminal to the measuring device

1. In the WLAN settings of the mobile terminal:
Select the measuring device using the SSID (e.g. EH_Promass_300_A802000).
2. If necessary, select the WPA2 encryption method.
3. Enter the password:
Serial number of the measuring device ex-works (e.g. L100A802000).
 - ↳ The LED on the display module flashes. It is now possible to operate the measuring device with the web browser, FieldCare or DeviceCare.



The serial number can be found on the nameplate.



To ensure the safe and swift assignment of the WLAN network to the measuring point, it is advisable to change the SSID name. It should be possible to clearly assign the new SSID name to the measuring point (e.g. tag name) because it is displayed as the WLAN network.

Terminating the WLAN connection

- ▶ After configuring the device:
Terminate the WLAN connection between the mobile terminal and measuring device.

Starting the web browser

1. Start the web browser on the computer.

2. Enter the IP address of the web server in the address line of the web browser:
192.168.1.212
↳ The login page appears.

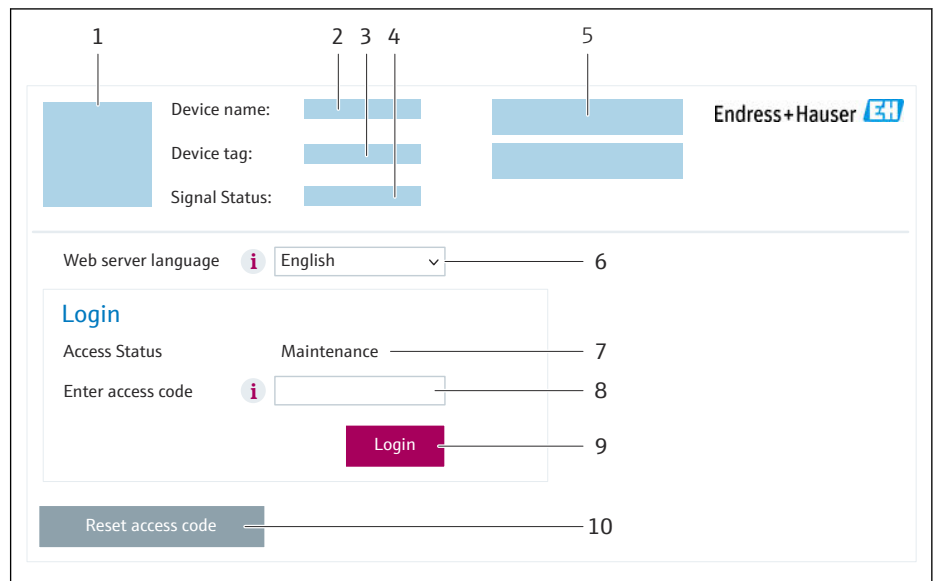

A0053670

- 1 Picture of device
- 2 Device name
- 3 Device tag
- 4 Status signal
- 5 Current measured values
- 6 Operating language
- 7 User role
- 8 Access code
- 9 Login
- 10 Reset access code (→ 136)

i If a login page does not appear, or if the page is incomplete → 156

8.4.4 Logging on

1. Select the preferred operating language for the Web browser.
2. Enter the user-specific access code.
3. Press **OK** to confirm your entry.

Access code	0000 (factory setting); can be changed by customer
--------------------	--

i If no action is performed for 10 minutes, the Web browser automatically returns to the login page.

8.4.5 User interface

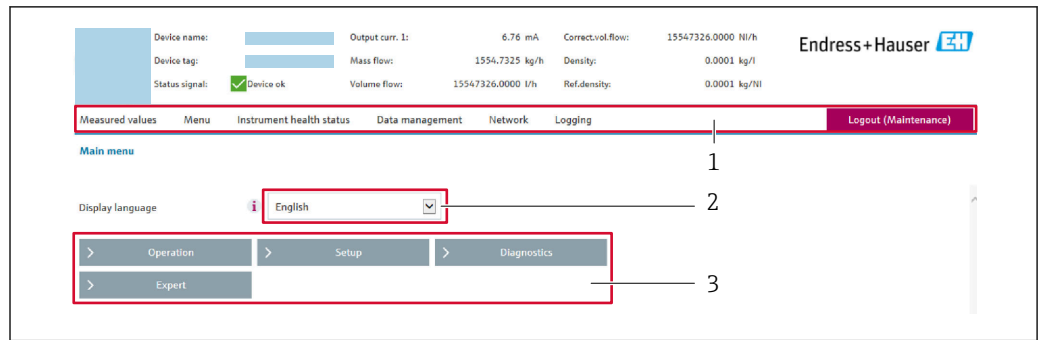

A0029418

- 1 Function row
- 2 Local display language
- 3 Navigation area

Header

The following information appears in the header:

- Device name
- Device tag
- Device status with status signal → 162
- Current measured values

Function row

Functions	Meaning
Measured values	Displays the measured values of the device
Menu	<ul style="list-style-type: none"> ■ Access to the operating menu from the measuring device ■ The structure of the operating menu is the same as for the local display  Detailed information on the operating menu structure: Description of Device Parameters
Device status	Displays the diagnostic messages currently pending, listed in order of priority
Data management	Data exchange between computer and measuring device: <ul style="list-style-type: none"> ■ Device configuration: <ul style="list-style-type: none"> ■ Load settings from the device (XML format, save configuration) ■ Save settings to the device (XML format, restore configuration) ■ Logbook - Export Event logbook (.csv file) ■ Documents - Export documents: <ul style="list-style-type: none"> ■ Export backup data record (.csv file, create documentation of the measuring point configuration) ■ Verification report (PDF file, only available with the "Heartbeat Verification" application package) ■ File for system integration - If using fieldbuses, upload device drivers for system integration from the measuring device: <ul style="list-style-type: none"> PROFINET: GSD file ■ Firmware update - Flashing a firmware version
Network	Configuration and checking of all the parameters required for establishing the connection to the measuring device: <ul style="list-style-type: none"> ■ Network settings (e.g. IP address, MAC address) ■ Device information (e.g. serial number, firmware version)
Logout	End the operation and call up the login page

Navigation area

The menus, the associated submenus and parameters can be selected in the navigation area.

Working area

Depending on the selected function and the related submenus, various actions can be performed in this area:

- Configuring parameters
- Reading measured values
- Calling up help text
- Starting an upload/download

8.4.6 Disabling the Web server

The Web server of the measuring device can be switched on and off as required using the **Web server functionality** parameter.

Navigation

"Expert" menu → Communication → Web server

Parameter overview with brief description

Parameter	Description	Selection
Web server functionality	Switch the Web server on and off.	<ul style="list-style-type: none"> ▪ Off ▪ HTML Off ▪ On

Function scope of the "Web server functionality" parameter

Option	Description
Off	<ul style="list-style-type: none"> ▪ The Web server is completely disabled. ▪ Port 80 is locked.
HTML Off	The HTML version of the Web server is not available.
On	<ul style="list-style-type: none"> ▪ The complete Web server functionality is available. ▪ JavaScript is used. ▪ The password is transferred in an encrypted state. ▪ Any change to the password is also transferred in an encrypted state.

Enabling the Web server

If the Web server is disabled it can only be re-enabled with the **Web server functionality** parameter via the following operating options:

- Via local display
- Via Bedientool "FieldCare"
- Via "DeviceCare" operating tool

8.4.7 Logging out

 Before logging out, perform a data backup via the **Data management** function (upload configuration from device) if necessary.

1. Select the **Logout** entry in the function row.
 - ↳ The home page with the Login box appears.
2. Close the Web browser.

3. If no longer needed:
Reset the modified properties of the Internet protocol (TCP/IP) →  65.

 If communication with the web server was established via the default IP address 192.168.1.212, DIP switch no. 10 must be reset (from **ON** → **OFF**). Afterwards, the IP address of the device is active again for network communication.

8.5 Access to the operating menu via the operating tool

The structure of the operating menu in the operating tools is the same as for operation via the local display.

8.5.1 Connecting the operating tool

Via PROFINET network

This communication interface is available in device versions with PROFINET.

Star topology

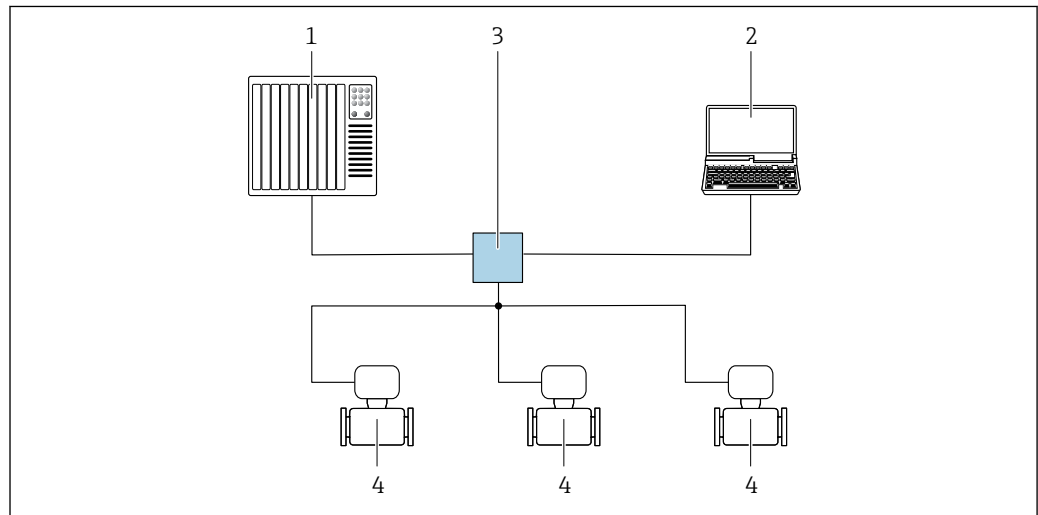

A0026545

 23 Options for remote operation via PROFINET network: star topology

- 1 Automation system, e.g. Simatic S7 (Siemens)
- 2 Computer with Web browser (e.g. Internet Explorer) for accessing the integrated Web server or computer with operating tool (e.g. FieldCare, DeviceCare, SIMATIC PDM) with COM DTM "CDI Communication TCP/IP"
- 3 Standard Ethernet switch, e.g. Scalance X204 (Siemens)
- 4 Measuring device

Ring topology

The device is integrated via the terminal connection for signal transmission (output 1) and the service interface (CDI-RJ45).

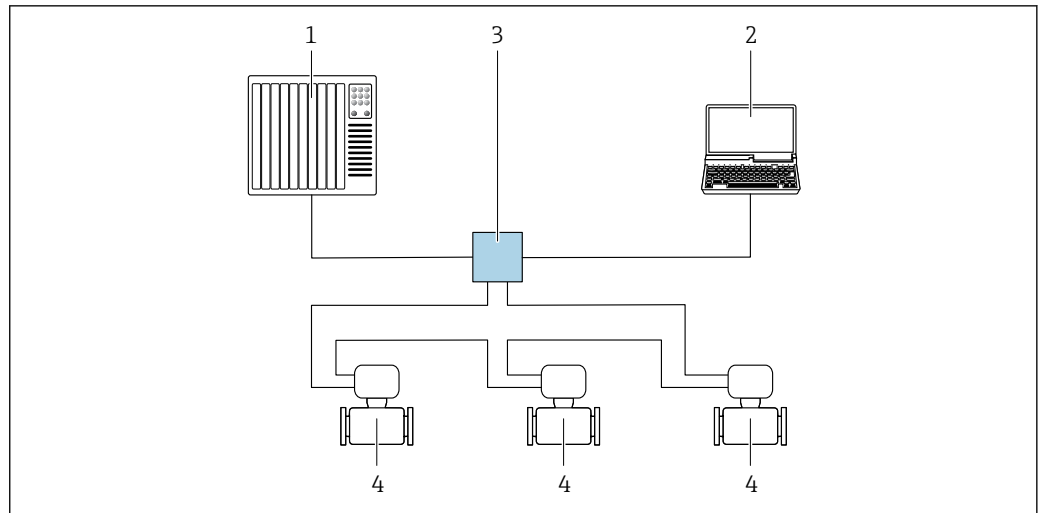

A0033719

24 Options for remote operation via PROFINET network: ring topology

- 1 Automation system, e.g. Simatic S7 (Siemens)
- 2 Computer with Web browser (e.g. Internet Explorer) for accessing the integrated Web server or computer with operating tool (e.g. FieldCare, DeviceCare, SIMATIC PDM) with COM DTM "CDI Communication TCP/IP"
- 3 Standard Ethernet switch, e.g. Scalance X204 (Siemens)
- 4 Measuring device

Service interface

Via service interface (CDI-RJ45)

A point-to-point connection can be established to configure the device onsite. With the housing open, the connection is established directly via the service interface (CDI-RJ45) of the device.

i An adapter for the RJ45 to the M12 plug is optionally available for the non-hazardous area:

Order code for "Accessories", option **NB**: "Adapter RJ45 M12 (service interface)"

The adapter connects the service interface (CDI-RJ45) to an M12 plug mounted in the cable entry. The connection to the service interface can be established via an M12 plug without opening the device.

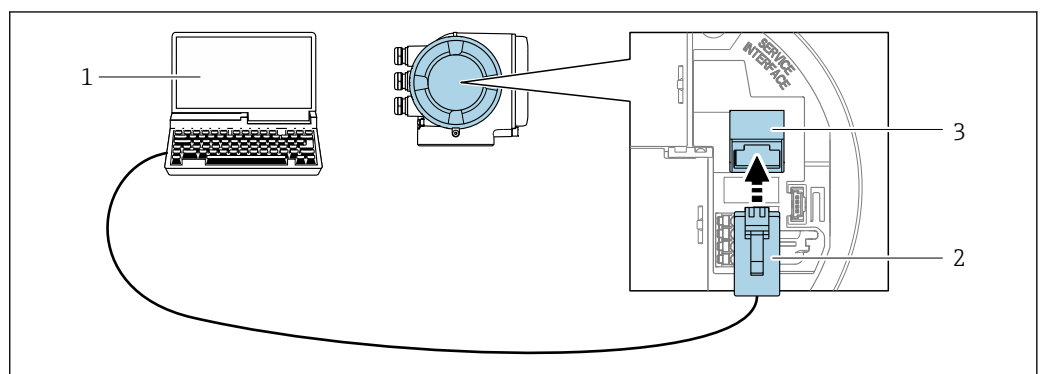

A0027563

25 Connection via service interface (CDI-RJ45)

- 1 Computer with web browser (e.g. Microsoft Internet Explorer, Microsoft Edge) for accessing the integrated web server or with "FieldCare" operating tool, "DeviceCare" with COM DTM "CDI Communication TCP/IP"
- 2 Standard Ethernet connecting cable with RJ45 plug
- 3 Service interface (CDI-RJ45) of the measuring device with access to the integrated Web server

Via WLAN interface

The optional WLAN interface is available on the following device version:

Order code for "Display; operation", option G "4-line, illuminated; touch control + WLAN"

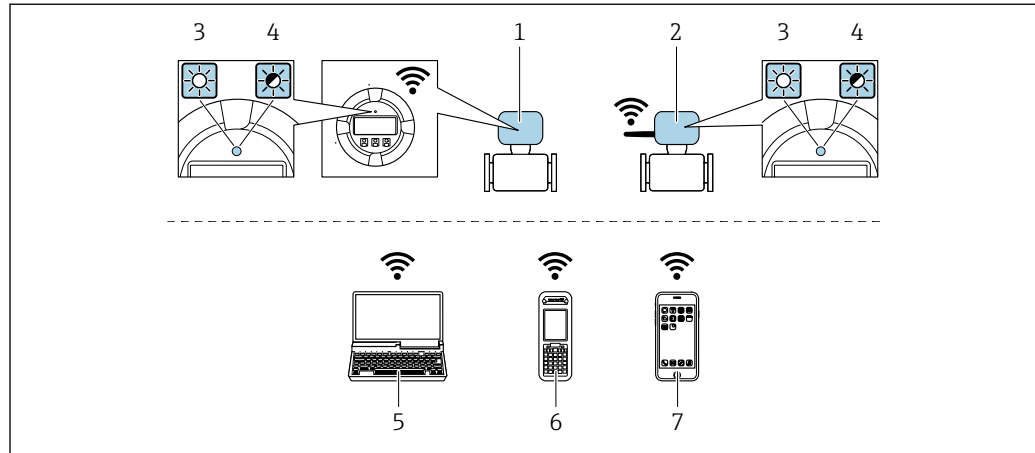

A0034570

- 1 Transmitter with integrated WLAN antenna
- 2 Transmitter with external WLAN antenna
- 3 LED lit constantly: WLAN reception is enabled on measuring device
- 4 LED flashing: WLAN connection established between operating unit and measuring device
- 5 Computer with WLAN interface and web browser (e.g. Microsoft Internet Explorer, Microsoft Edge) for accessing the integrated device web server or with operating tool (e.g. FieldCare, DeviceCare)
- 6 Mobile handheld terminal with WLAN interface and web browser (e.g. Microsoft Internet Explorer, Microsoft Edge) for accessing the integrated device web server or operating tool (e.g. FieldCare, DeviceCare)
- 7 Smart phone or tablet (e.g. Field Xpert SMT70)

Function	WLAN: IEEE 802.11 b/g (2.4 GHz)
Encryption	WPA2-PSK AES-128 (in accordance with IEEE 802.11i)
Configurable WLAN channels	1 to 11
Degree of protection	IP67
Available antennas	<ul style="list-style-type: none"> ▪ Internal antenna ▪ External antenna (optional) <p>In the event of poor transmission/reception conditions at the place of installation.</p> <p> Only 1 antenna is active at any one time!</p>
Range	<ul style="list-style-type: none"> ▪ Internal antenna: typically 10 m (32 ft) ▪ External antenna: typically 50 m (164 ft)
Materials (external antenna)	<ul style="list-style-type: none"> ▪ Antenna: ASA plastic (acrylonitrile styrene acrylate) and nickel-plated brass ▪ Adapter: Stainless steel and nickel-plated brass ▪ Cable: Polyethylene ▪ Plug: Nickel-plated brass ▪ Angle bracket: Stainless steel

Configuring the Internet protocol of the mobile terminal

NOTICE

If the WLAN connection is lost during the configuration, settings made may be lost.

- ▶ Make sure that the WLAN connection is not disconnected while configuring the device.

NOTICE**Note the following to avoid a network conflict:**

- ▶ Avoid accessing the measuring device simultaneously from the same mobile terminal via the service interface (CDI-RJ45) and the WLAN interface.
- ▶ Only activate one service interface (CDI-RJ45 or WLAN interface).
- ▶ If simultaneous communication is necessary: configure different IP address ranges, e.g. 192.168.0.1 (WLAN interface) and 192.168.1.212 (CDI-RJ45 service interface).

Preparing the mobile terminal

- ▶ Enable WLAN on the mobile terminal.

Establishing a WLAN connection from the mobile terminal to the measuring device

1. In the WLAN settings of the mobile terminal:
Select the measuring device using the SSID (e.g. EH_Promass_300_A802000).
2. If necessary, select the WPA2 encryption method.
3. Enter the password:
Serial number of the measuring device ex-works (e.g. L100A802000).
↳ The LED on the display module flashes. It is now possible to operate the measuring device with the web browser, FieldCare or DeviceCare.



The serial number can be found on the nameplate.



To ensure the safe and swift assignment of the WLAN network to the measuring point, it is advisable to change the SSID name. It should be possible to clearly assign the new SSID name to the measuring point (e.g. tag name) because it is displayed as the WLAN network.

Terminating the WLAN connection

- ▶ After configuring the device:
Terminate the WLAN connection between the mobile terminal and measuring device.

8.5.2 FieldCare

Function range

FDT-based (Field Device Technology) plant asset management tool from Endress+Hauser. It can configure all smart field units in a system and helps you manage them. By using the status information, it is also a simple but effective way of checking their status and condition.

Access is via:

- CDI-RJ45 service interface → 71
- WLAN interface → 72

Typical functions:

- Transmitter parameter configuration
- Loading and saving of device data (upload/download)
- Documentation of the measuring point
- Visualization of the measured value memory (line recorder) and event logbook



- Operating Instructions BA00027S
- Operating Instructions BA00059S



Source for device description files → 76

Establishing a connection

1. Start FieldCare and launch the project.

2. In the network: Add a device.
↳ The **Add device** window opens.
3. Select the **CDI Communication TCP/IP** option from the list and press **OK** to confirm.
4. Right-click **CDI Communication TCP/IP** and select the **Add device** option in the context menu that opens.
5. Select the desired device from the list and press **OK** to confirm.
↳ The **CDI Communication TCP/IP (Configuration)** window opens.
6. Enter the device address in the **IP address** field: 192.168.1.212 and press **Enter** to confirm.
7. Establish the online connection to the device.

- 
 - Operating Instructions BA00027S
 - Operating Instructions BA00059S

User interface

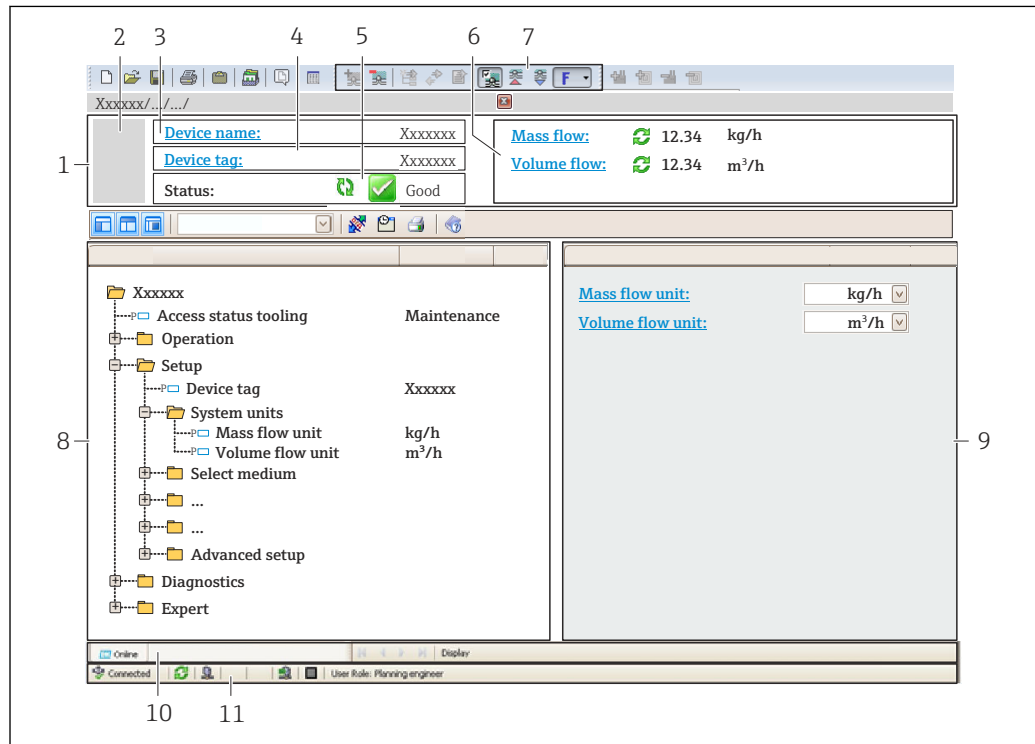

A0021051-EN

- 1 Header
- 2 Picture of device
- 3 Device name
- 4 Device tag
- 5 Status area with status signal →  162
- 6 Display area for current measured values
- 7 Editing toolbar with additional functions such as save/load, event list and create documentation
- 8 Navigation area with operating menu structure
- 9 Work area
- 10 Action area
- 11 Status area

8.5.3 DeviceCare

Function range

Tool for connecting and configuring Endress+Hauser field devices.

The fastest way to configure Endress+Hauser field devices is with the dedicated "DeviceCare" tool. Together with the device type managers (DTMs) it presents a convenient, comprehensive solution.



Innovation brochure IN01047S



Source for device description files →  76

9 System integration

9.1 Overview of device description files

9.1.1 Current version data for the device

Firmware version	01.01.zz	<ul style="list-style-type: none"> ▪ On the title page of the manual ▪ On the transmitter nameplate ▪ Firmware version Diagnostics → Device information → Firmware version
Release date of firmware version	07.2019	–
Manufacturer ID	0x11	Manufacturer ID Diagnostics → Device information → Manufacturer ID
Device ID	0x843B	Device ID Expert → Communication → PROFINET configuration → PROFINET information → Device ID
Device type ID	Promass 300	Device Type Expert → Communication → PROFINET configuration → PROFINET information → Device Type
Device revision	2	Device revision Expert → Communication → PROFINET configuration → PROFINET information → Device revision
PROFINET version	2.3.x	–



For an overview of the various firmware versions for the device → 223

9.1.2 Operating tools

The suitable device description file for the individual operating tools is listed in the table below, along with information on where the file can be acquired.

Operating tool via Service interface (CDI-RJ45)	Sources for obtaining device descriptions
FieldCare	<ul style="list-style-type: none"> ▪ www.endress.com → Downloads area ▪ USB stick (contact Endress+Hauser) ▪ DVD (contact Endress+Hauser)
DeviceCare	<ul style="list-style-type: none"> ▪ www.endress.com → Downloads area ▪ CD-ROM (contact Endress+Hauser) ▪ DVD (contact Endress+Hauser)

9.2 Device master file (GSD)

In order to integrate field devices into a bus system, the PROFIBUS system needs a description of the device parameters, such as output data, input data, data format and data volume.

These data are available in the device master file (GSD) which is provided to the automation system when the communication system is commissioned. In addition device bit maps, which appear as icons in the network structure, can also be integrated.

The device master file (GSD) is in XML format, and the file is created in the GSDML description markup language.

With the PA Profile 4.02 device master file (GSD) it is possible to exchange field devices made by different manufacturers without having to reconfigure.

Two different device master files (GSD) can be used: Manufacturer-specific GSD and PA Profile GSD.

9.2.1 File name of the manufacturer-specific device master file (GSD)

Example of the name of a device master file:

GSDML-V2.3.x-EH-PROMASS 300-yyyymmdd.xml

GSDML	Description language
V2.3.x	Version of the PROFINET specification
EH	Endress+Hauser
PROMASS	Instrument family
300	Transmitter
yyyymmdd	Date of issue (yyyy: year, mm: month, dd: day)
.xml	File name extension (XML file)

9.2.2 File name of the PA Profile device master file (GSD)

9.3 Cyclic data transmission

9.3.1 Overview of the modules

The following graphic shows which modules are available to the device for cyclic data transfer. Cyclic data transfer is performed with an automation system.

API	Measuring device		Sub-slot	Direction Data flow	Control system
	Modules	Slot			
0x9700	Analog Input 1 (Mass flow)	1	1	→	PROFINET
	Analog Input 2 (Density)	2	1	→	
	Analog Input 3 (Temperature)	3	1	→	
	Analog Input 4	20	1	→	
	Analog Input 5	21	1	→	
	Analog Input 6	22	1	→	
	Analog Input 7	23	1	→	
	Analog Input 8	24	1	→	
	Analog Input 9	25	1	→	
	Analog Input 10	26	1	→	
	Analog Input 11	27	1	→	
	Analog Input 12	28	1	→	
	Analog Input 13	29	1	→	
	Analog Input 14	30	1	→	
	Analog Input 15	31	1	→	
	Analog Input 16	32	1	→	
	Totalizer 1 (Mass)	4	1	→ ←	
	Totalizer 2	70	1	→ →	
	Totalizer 3	71	1	→ ←	
	Binary Input 1 (Heartbeat)	80	1	→	
	Binary Input 2	81	1	→	
	Analog Output 1 (Pressure)	160	1	←	
	Analog Output 2 (Temperature)	161	1	←	
	Analog Output 3 (Ref. density)	162	1	←	
	Analog Output 4 (% Sediment and water)	163	1	←	
	Analog Output 5 (Water cut percentage)	164	1	←	
	Analog Output 6 (Appl. Spec. out 0)	165	1	←	
	Analog Output 7 (Appl. Spec. out 1)	166	1	←	
	Binary Output 1 (Heartbeat)	210	1	→	
	Binary Output 2	211	1	←	
	Enumerated Output	240	1	←	

9.3.2 Description of the modules

Analog Input module

Data structure

Output data of Analog Output

Byte 1	Byte 2	Byte 3	Byte 4	Byte 5
Measured value: floating point number (IEEE 754)				Status ¹⁾

1) Status coding →  84

Application-specific Input module

Transmit compensation values from the measuring device to the automation system.

The Application-specific Input module cyclically transmits compensation values, including the status, from the measuring device to the automation system. The compensation value is depicted in the first four bytes in the form of a floating point number as per the IEEE 754 standard. The fifth byte contains standardized status information pertaining to the compensation value.

Assigned compensation values

 The configuration is performed via: Expert → Application → Application specific calculations → Process variables

Slot	Compensation value
31	Application-specific Input module
32	Application-specific Input module

Data structure

Input data of Application-specific Input module

Byte 1	Byte 2	Byte 3	Byte 4	Byte 5
Measured value: floating point number (IEEE 754)				Status ¹⁾

1) Status coding →  84

Failsafe mode

A failsafe mode can be defined for using the compensation values.

If the status is GOOD or UNCERTAIN, the compensation values transmitted by the automation system are used. If the status is BAD, the failsafe mode is activated for the use of the compensation values.

Parameters are available per compensation value to define the failsafe mode: Expert → Application → Application specific calculations → Process variables

Fail safe type parameter

- **Fail-safe value** option: The value defined in the Fail safe value parameter is used.
- **Fallback value** option: The last valid value is used.
- **Off** option: Failsafe mode is disabled.

Fail safe value parameter

Use this parameter to enter the compensation value which is used if the Fail safe value option is selected in the Fail safe type parameter.

Binary input module

Transmit binary input variables from the measuring device to the automation system.

Selection: device function, binary input, slot 80

Slot	Sub-slot	Bit	Device function	Status (meaning)
80	1	0	Verification was not performed.	<ul style="list-style-type: none"> ▪ 0 (device function not active) ▪ 1 (device function active)
		1	The device has failed the verification.	
		2	Currently performing verification.	
		3	Verification ended.	
		4	The device has failed the verification.	
		5	Verification carried out successfully.	
		6	Verification was not performed.	
		7	Reserved	

Selection: device function, binary input, slot 81

Data structure

Input data of Binary Input

Byte 1	Byte 2
Binary Input	Status ¹⁾

1) Status coding →  84

Mass module

Transmit mass counter value from the measuring device to the automation system.

Selection: input variable

Slot	Sub-slot	Input variables
4	1	Mass

Data structure

Volume input data

Byte 1	Byte 2	Byte 3	Byte 4	Byte 5
Measured value: floating point number (IEEE 754)				Status ¹⁾

1) Status coding →  84

Mass Totalizer Control module

Transmit totalizer value from the measuring device to the automation system.

Selection: input variable

Slot	Sub-slot	Input variable
4	1	Mass

Data structure

Mass Totalizer Control input data

Byte 1	Byte 2	Byte 3	Byte 4	Byte 5
Measured value: floating point number (IEEE 754)				Status ¹⁾

1) Status coding → 84

Selection: output variable

Transmit the control value from the automation system to the measuring device.

Slot	Sub-slot	Value	Input variable
70...71	1	1	Reset to "0"
		2	Preset value
		3	Stop
		4	Totalize

Data structure

Mass Totalizer Control output data

Byte 1
Control variable

Totalizer module

Transmit totalizer value from the measuring device to the automation system.

Data structure

Totalizer input data

Byte 1	Byte 2	Byte 3	Byte 4	Byte 5
Measured value: floating point number (IEEE 754)				Status ¹⁾

1) Status coding → 84

Totalizer Control module

Transmit totalizer value from the measuring device to the automation system.

Selection: input variable

Data structure

Totalizer Control input data

Byte 1	Byte 2	Byte 3	Byte 4	Byte 5
Measured value: floating point number (IEEE 754)				Status ¹⁾

1) Status coding → 84

Selection: output variable

Transmit the control value from the automation system to the measuring device.

Slot	Sub-slot	Value	Input variable
70 to 71	1	1	Reset to "0"
		2	Preset value
		3	Stop
		4	Totalize

Data structure

Totalizer Control output data

Byte 1
Control variable

Analog Output module

Transmit a compensation value from the automation system to the measuring device.

Analog Output modules cyclically transmit compensation values, including the status and associated unit, from the automation system to the measuring device. The compensation value is depicted in the first four bytes in the form of a floating point number as per the IEEE 754 standard. The fifth byte contains standardized status information pertaining to the compensation value.

Assigned compensation values



The selection is made via: Expert → Sensor → External compensation

Data structure

Output data of Analog Output

Byte 1	Byte 2	Byte 3	Byte 4	Byte 5
Measured value: floating point number (IEEE 754)				Status ¹⁾

1) Status coding → 84

Failsafe mode

A failsafe mode can be defined for using the compensation values.

If the status is GOOD or UNCERTAIN, the compensation values transmitted by the automation system are used. If the status is BAD, the failsafe mode is activated for the use of the compensation values.

Parameters are available per compensation value to define the failsafe mode: Expert → Sensor → External compensation

Fail safe type parameter

- Fail safe value option: The value defined in the Fail safe value parameter is used.
- Fallback value option: The last valid value is used.
- Off option: The failsafe mode is disabled.

Fail safe value parameter

Use this parameter to enter the compensation value which is used if the Fail safe value option is selected in the Fail safe type parameter.

Binary output module

Transmit binary output values from the automation system to the measuring device.

Selection: device function, binary output, slot 210

Slot	Sub-slot	Bit	Device function	Status (meaning)
210	1	0	Start the verification.	A change of status from 0 to 1 starts the Heartbeat Verification ¹⁾
		1	Reserved	
		2	Reserved	
		3	Reserved	
		4	Reserved	
		5	Reserved	
		6	Reserved	
		7	Reserved	

1) Only available with the Heartbeat application package

Selection: device function, binary output, slot 211

Data structure

Binary Output input data

Byte 1	Byte 2
Binary Output	Status ^{1) 2)}

1) Status coding → 84

2) If the status is BAD, the control variable is not adopted.

Concentration module

 Only available with the Concentration Measurement application package.

Assigned device functions

Slot	Input variables
28	Selection of the liquid type

Data structure

Concentration output data

Byte 1
Control variable

Liquid type	Enum code
Off	0
Sucrose in water	5
Glucose in water	2
Fructose in water	1

Liquid type	Enum code
Invert sugar in water	6
Corn syrup HFCS42	15
Corn syrup HFCS55	16
Corn syrup HFCS90	17
Original wort	18
Ethanol in water	11
Methanol in water	12
Hydrogen peroxide in water	4
Hydrochloric acid	24
Sulfuric acid	25
Nitric acid	7
Phosphoric acid	8
Sodium hydroxide	10
Potassium hydroxide	9
Ammonium nitrate in water	13
Iron(III) chloride in water	14
% mass / % volume	19
User Profile Coef Set No. 1	21
User Profile Coef Set No. 2	22
User Profile Coef Set No. 3	23

9.3.3 Status coding

Status	Coding (hex)	Meaning
BAD - Maintenance alarm	0x24 to 0x27	A measured value is not available because a device error has occurred.
BAD - Process related	0x28 to 0x2B	A measured value is not available because the process conditions are not within the device's technical specification limits.
BAD - Function check	0x3C to 0x3F	A function check is active (e.g. cleaning or calibration)
UNCERTAIN - Initial value	0x4F to 0x4F	A predefined value is output until a correct measured value is available again or corrective measures have been performed that change this status.
UNCERTAIN - Maintenance demanded	0x68 to 0x6B	Signs of wear and tear have been detected on the measuring instrument. Short-term maintenance is needed to ensure that the measuring instrument remains operational. The measured value might be invalid. The use of the measured value depends on the application.
UNCERTAIN - Process related	0x78 to 0x7B	The process conditions are not within the device's technical specification limits. This could have a negative impact on the quality and accuracy of the measured value. The use of the measured value depends on the application.
GOOD - OK	0x80 to 0x83	No error has been diagnosed.
GOOD - Maintenance required	0xA4 to 0xA7	The measured value is valid. Maintenance of the device due in the near future.

Status	Coding (hex)	Meaning
GOOD - Maintenance demanded	0xA8 to 0xAB	The measured value is valid. It is highly advisable to service the device in the near future.
GOOD - Function check	0xBC to 0xBF	The measured value is valid. The measuring instrument is performing an internal function check. The function check does not have any noticeable effect on the process.

9.3.4 Factory setting

The slots are already assigned in the automation system for initial commissioning.

Assigned slots

Slot	Factory setting
1	Mass flow
2	Volume flow
3	Corrected volume flow
4	Density
5	Reference density
6	Temperature
7 to 14	-
15	Totalizer 1
16	Totalizer 2
17	Totalizer 3

9.4 System redundancy S2

A redundant layout with two automation systems is necessary for processes that are in continuous operation. If one system fails the second system guarantees continued, uninterrupted operation. The measuring device supports S2 system redundancy and can communicate with both automation systems simultaneously.

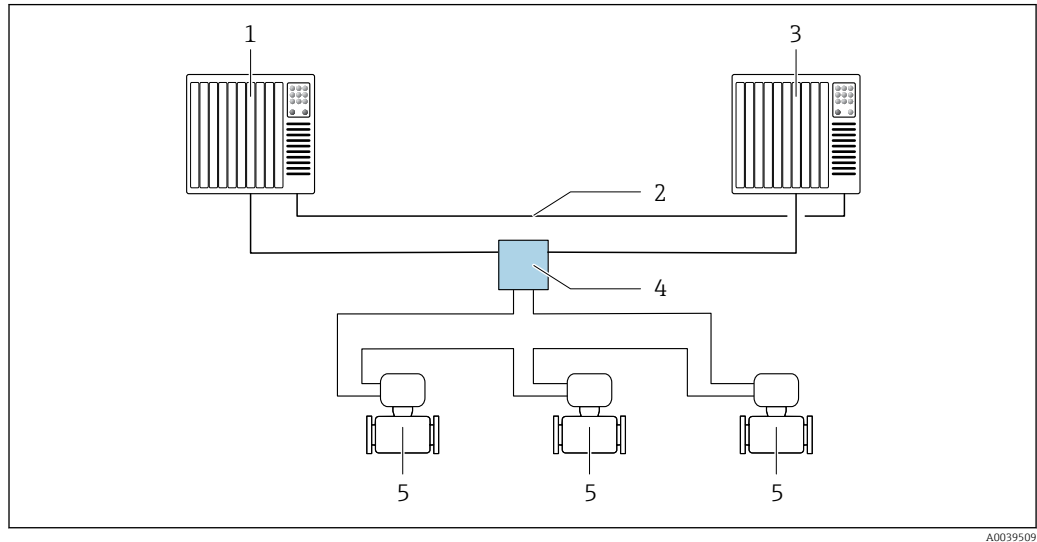

A0039509

26 Example of the layout of a redundant system (S2): ring topology

- 1 Automation system 1
- 2 Synchronization of automation systems
- 3 Automation system 2
- 4 Industrial Ethernet Managed Switch
- 5 Measuring device

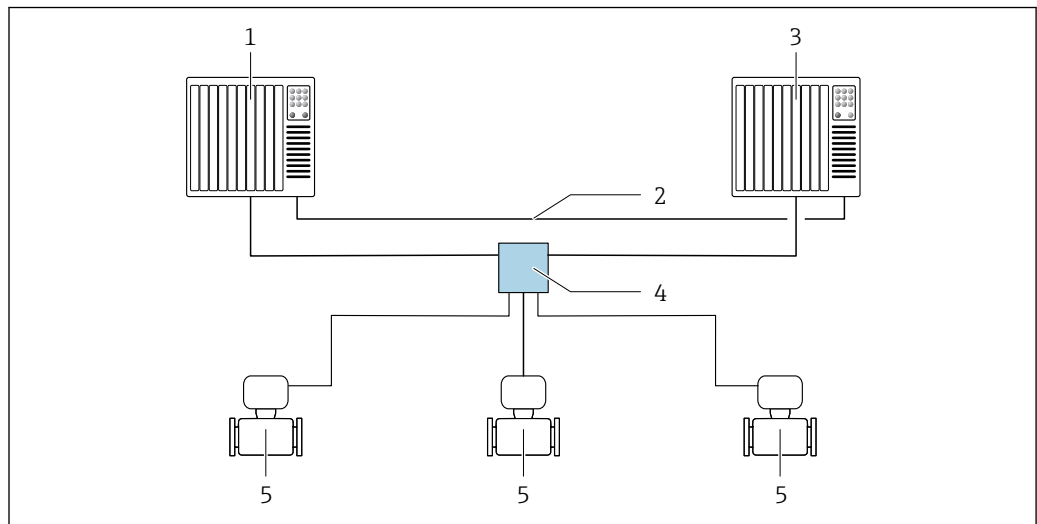

A0039178

27 Example of the layout of a redundant system (S2): star topology

- 1 Automation system 1
- 2 Synchronization of automation systems
- 3 Automation system 2
- 4 Industrial Ethernet Managed Switch
- 5 Measuring device



All the devices in the network must support S2 system redundancy.

10 Commissioning

10.1 Post-mounting and post-connection check

Before commissioning the device:

- ▶ Make sure that the post-installation and post-connection checks have been performed successfully.
- Checklist for "Post-installation" check → 31
- Checklist for "Post-connection" check → 48

10.2 Switching on the measuring device

- ▶ Switch on the device upon successful completion of the post-mounting and post-connection check.
 - ↳ After a successful startup, the local display switches automatically from the startup display to the operational display.

If nothing appears on the local display or if a diagnostic message is displayed, refer to the section on "Diagnostics and troubleshooting" → 155.

10.3 Connecting via FieldCare

- For connecting FieldCare → 71
- For connecting via FieldCare → 73
- For user interface of FieldCare → 74

10.4 Setting the operating language

Factory setting: English or ordered local language

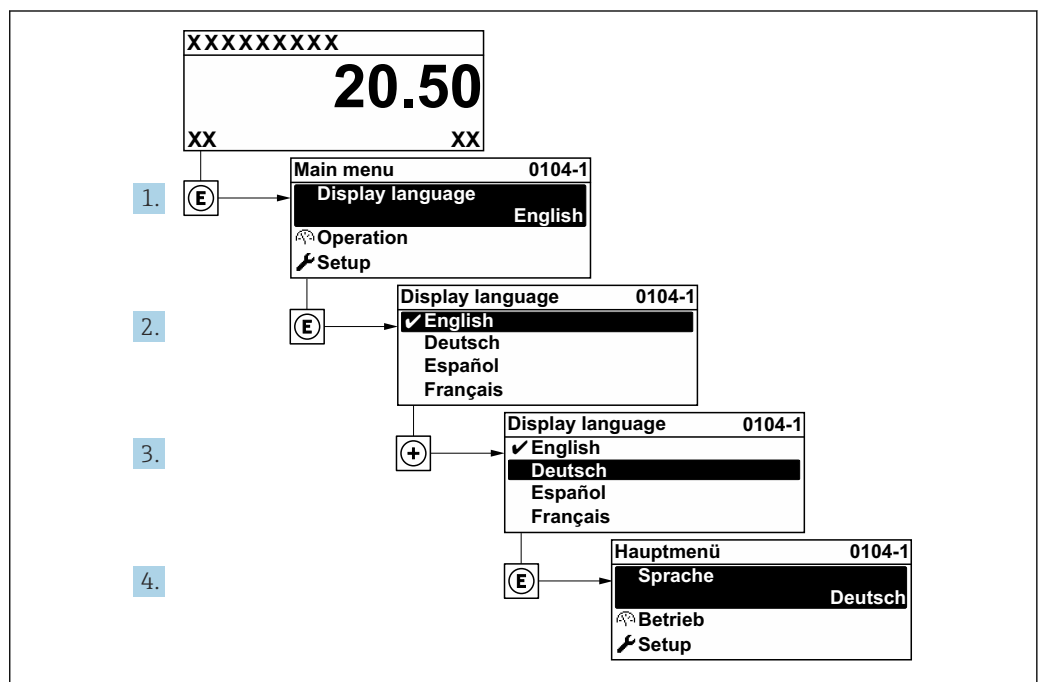

28 Taking the example of the local display

A0029420

10.5 Configuring the measuring instrument

The **Setup** menu with its guided wizards contains all the parameters needed for standard operation.

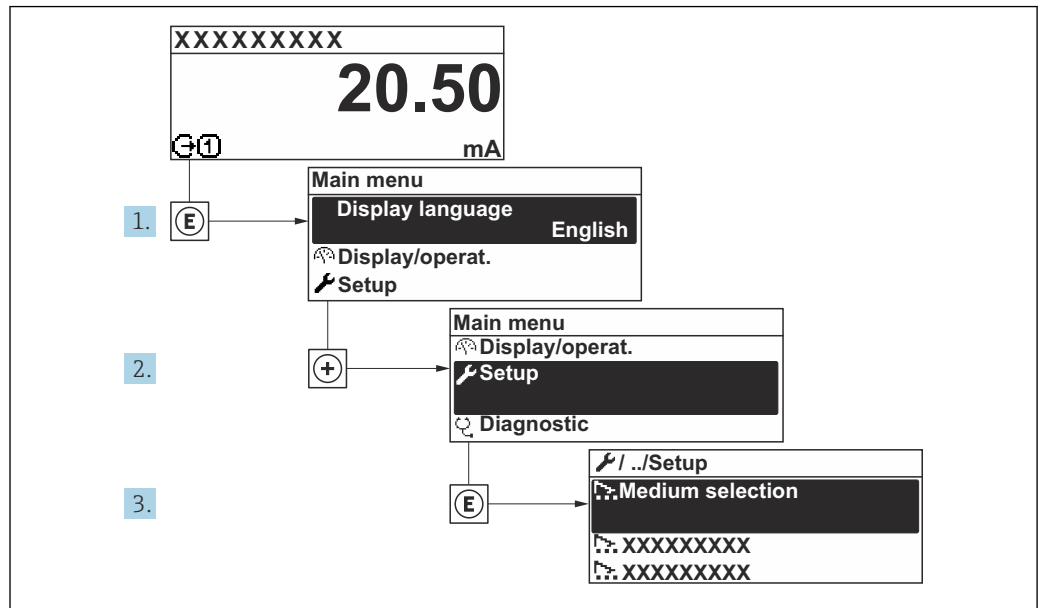

29 Navigation to "Setup" menu using the example of the local display

i The number of submenus and parameters can vary depending on the device version. Certain submenus and parameters in these submenus are not described in the Operating Instructions. Instead a description is provided in the Special Documentation for the device ("Supplementary documentation").

🔧 Setup	
Name of station	→ 89
▶ System units	→ 90
▶ Communication	→ 89
▶ Medium selection	→ 93
▶ I/O configuration	→ 95
▶ Current input 1 to n	→ 96
▶ Status input 1 to n	→ 97
▶ Current output 1 to n	→ 98
▶ Pulse/frequency/switch output 1 to n	→ 102
▶ Relay output 1 to n	→ 109

▶ Display	→ ⓘ 112
▶ Low flow cut off	→ ⓘ 115
▶ Partially filled pipe detection	→ ⓘ 116
▶ Advanced setup	→ ⓘ 117

10.5.1 Defining the tag name

A measuring point can be quickly identified within a plant on the basis of the tag name. The tag name is equivalent to the device name (name of station) of the PROFINET specification (data length: 255 bytes)

The device name can be changed via DIP switches or the automation system .

The device name currently used is displayed in the **Name of station** parameter.

Navigation

"Setup" menu → PROFINET device name

Parameter overview with brief description

Parameter	Description	User interface	Factory setting
Name of station	Name of the measuring point.	Max. 32 characters such as letters and numbers.	EH-PROMASS300 serial number of the device

10.5.2 Displaying the communication interface

The **Communication** submenu shows all the current parameter settings for selecting and configuring the communication interface.

Navigation

"Setup" menu → Communication

▶ Communication	
MAC address (7214)	→ ⓘ 90
IP address (7209)	→ ⓘ 90
Subnet mask (7211)	→ ⓘ 90
Default gateway (7210)	→ ⓘ 90

Parameter overview with brief description

Parameter	Description	User interface / User entry	Factory setting
MAC address	Displays the MAC address of the measuring device.  MAC = Media Access Control	Unique 12-digit character string comprising letters and numbers, e.g.: 00:07:05:10:01:5F	Each measuring device is given an individual address.
IP address	IP address of the Web server integrated in the measuring device. If the DHCP client is switched off and write access is enabled, the IP address can also be entered.	4 octet: 0 to 255 (in the particular octet)	–
Subnet mask	Displays the subnet mask. If the DHCP client is switched off and write access is enabled, the Subnet mask can also be entered.	4 octet: 0 to 255 (in the particular octet)	–
Default gateway	Displays the default gateway. If the DHCP client is switched off and write access is enabled, the Default gateway can also be entered.	4 octet: 0 to 255 (in the particular octet)	–









10.5.3 Setting the system units



In the **System units** submenu the units of all the measured values can be set.

 The number of submenus and parameters can vary depending on the device version. Certain submenus and parameters in these submenus are not described in the Operating Instructions. Instead a description is provided in the Special Documentation for the device ("Supplementary documentation").

Navigation

"Setup" menu → System units

► System units	
Mass flow unit	→  91
Mass unit	→  91
Volume flow unit	→  91
Volume unit	→  91
Corrected volume flow unit	→  91
Corrected volume unit	→  91
Density unit	→  91
Reference density unit	→  91

Temperature unit	→  92
Pressure unit	→  92

Parameter overview with brief description

Parameter	Description	Selection	Factory setting
Mass flow unit	Select mass flow unit. <i>Effect</i> The selected unit applies to: <ul style="list-style-type: none"> ▪ Output ▪ Low flow cut off ▪ Simulation process variable 	Unit choose list	Country-specific: <ul style="list-style-type: none"> ▪ kg/h ▪ lb/min
Mass unit	Select mass unit.	Unit choose list	Country-specific: <ul style="list-style-type: none"> ▪ kg ▪ lb
Volume flow unit	Select volume flow unit. <i>Effect</i> The selected unit applies to: <ul style="list-style-type: none"> ▪ Output ▪ Low flow cut off ▪ Simulation process variable 	Unit choose list	Country-specific: <ul style="list-style-type: none"> ▪ l/h ▪ gal/min (us)
Volume unit	Select volume unit.	Unit choose list	Country-specific: <ul style="list-style-type: none"> ▪ l ▪ gal (us)
Corrected volume flow unit	Select corrected volume flow unit. <i>Effect</i> The selected unit applies to: Corrected volume flow parameter (→  144)	Unit choose list	Country-specific: <ul style="list-style-type: none"> ▪ NI/h ▪ Sft³/min
Corrected volume unit	Select corrected volume unit.	Unit choose list	Country-specific: <ul style="list-style-type: none"> ▪ NI ▪ Sft³
Density unit	Select density unit. <i>Effect</i> The selected unit applies to: <ul style="list-style-type: none"> ▪ Output ▪ Simulation process variable ▪ Density adjustment (Expert menu) 	Unit choose list	Country-specific: <ul style="list-style-type: none"> ▪ kg/l ▪ lb/ft³
Reference density unit	Select reference density unit.	Unit choose list	Country-specific <ul style="list-style-type: none"> ▪ kg/NI ▪ lb/Sft³
Density 2 unit	Select second density unit.	Unit choose list	Country-specific: <ul style="list-style-type: none"> ▪ kg/l ▪ lb/ft³

Parameter	Description	Selection	Factory setting
Temperature unit	<p>Select temperature unit.</p> <p><i>Effect</i></p> <p>The selected unit applies to:</p> <ul style="list-style-type: none"> ▪ Electronic temperature parameter (6053) ▪ Maximum value parameter (6051) ▪ Minimum value parameter (6052) ▪ External temperature parameter (6080) ▪ Maximum value parameter (6108) ▪ Minimum value parameter (6109) ▪ Maximum value parameter (6029) ▪ Minimum value parameter (6030) ▪ Reference temperature parameter (1816) ▪ Temperature parameter 	Unit choose list	<p>Country-specific:</p> <ul style="list-style-type: none"> ▪ °C ▪ °F
Pressure unit	<p>Select process pressure unit.</p> <p><i>Effect</i></p> <p>The unit is taken from:</p> <ul style="list-style-type: none"> ▪ Pressure value parameter (→ ⓘ 94) ▪ External pressure parameter (→ ⓘ 94) ▪ Pressure value 	Unit choose list	<p>Country-specific:</p> <ul style="list-style-type: none"> ▪ bar a ▪ psi a

10.5.4 Selecting and setting the medium

The **Select medium** wizard submenu contains parameters that must be configured in order to select and set the medium.

Navigation

"Setup" menu → Medium selection

▶ **Medium selection**

Select medium	→ ⓘ 93
Select gas type	→ ⓘ 93
Reference sound velocity	→ ⓘ 94
Temperature coefficient sound velocity	→ ⓘ 94
Pressure compensation	→ ⓘ 94
Pressure value	→ ⓘ 94
External pressure	→ ⓘ 94

Parameter overview with brief description

Parameter	Prerequisite	Description	Selection / User entry / User interface
Select medium	–	Use this function to select the type of medium: "Gas" or "Liquid". Select the "Other" option in exceptional cases in order to enter the properties of the medium manually (e.g. for highly compressive liquids such as sulfuric acid).	<ul style="list-style-type: none"> ■ Liquid ■ Gas
Select gas type	In the Medium selection submenu, the Gas option is selected.	Select measured gas type.	<ul style="list-style-type: none"> ■ Air ■ Ammonia NH3 ■ Argon Ar ■ Sulfur hexafluoride SF6 ■ Oxygen O2 ■ Ozone O3 ■ Nitrogen oxide NOx ■ Nitrogen N2 ■ Nitrous oxide N2O ■ Methane CH4 ■ Hydrogen H2 ■ Helium He ■ Hydrogen chloride HCl ■ Hydrogen sulfide H2S ■ Ethylene C2H4 ■ Carbon dioxide CO2 ■ Carbon monoxide CO ■ Chlorine Cl2 ■ Butane C4H10 ■ Propane C3H8 ■ Propylene C3H6 ■ Ethane C2H6 ■ Others

Parameter	Prerequisite	Description	Selection / User entry / User interface
Reference sound velocity	In the Select gas type parameter, the Others option is selected.	Enter sound velocity of gas at 0 °C (32 °F).	1 to 99 999.9999 m/s
Reference sound velocity	In the Select medium type parameter, the Others option is selected.	Enter sound velocity of gas at 0 °C (32 °F).	Signed floating-point number
Temperature coefficient sound velocity	In the Select gas type parameter, the Others option is selected.	Enter temperature coefficient for the gas sound velocity.	Positive floating point number
Temperature coefficient sound velocity	In the Select medium type parameter, the Others option is selected.	Enter temperature coefficient for the gas sound velocity.	Signed floating-point number
Pressure compensation	–	Select pressure compensation type.	<ul style="list-style-type: none"> ■ Off ■ Fixed value ■ External value ■ Current input 1 * ■ Current input 2 *
Pressure value	In the Pressure compensation parameter, the Fixed value option is selected.	Enter process pressure to be used for pressure correction.	Positive floating-point number
External pressure	In the Pressure compensation parameter, the External value option or the Current input 1...n option is selected.	Shows the external process pressure value.	

* Visibility depends on order options or device settings

10.5.5 Configuration of the Analog Inputs

The **Analog inputs** submenu guides the user systematically to the individual **Analog input 1 to n** submenu. From here you get to the parameters of the individual analog input.

Navigation

"Setup" menu → Analog inputs

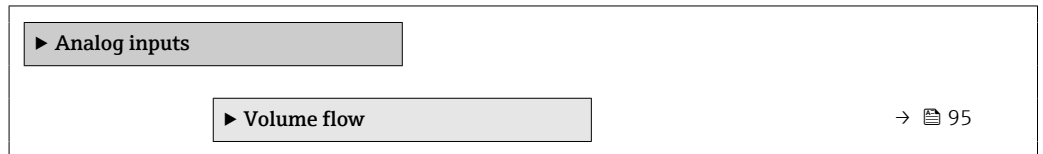

"Analog inputs" submenu

Navigation

"Setup" menu → Analog inputs → Volume flow

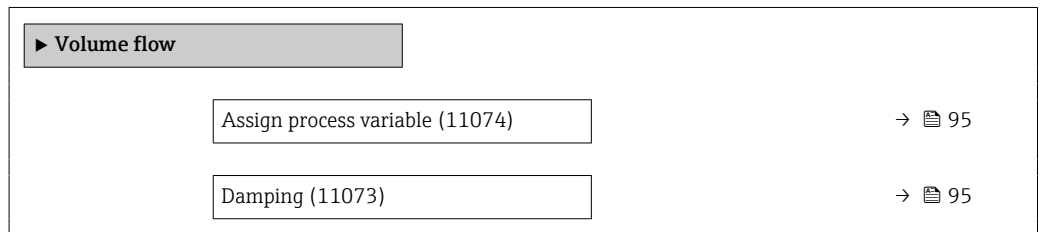

Parameter overview with brief description

Parameter	Description	User interface / User entry
Parent class		0 to 255
Assign process variable	Select a process variable.	<ul style="list-style-type: none"> ▪ Mass flow ▪ Volume flow ▪ Density ▪ Temperature ▪ Pressure ▪ Specific volume ▪ Degrees of superheat ▪ Electronic temperature ▪ Vortex frequency ▪ Vortex kurtosis ▪ Vortex amplitude ▪ Calculated saturated steam pressure ▪ Steam quality ▪ Total mass flow ▪ Condensate mass flow ▪ Energy flow ▪ Heat flow difference ▪ Reynolds number ▪ Flow velocity ▪ Corrected volume flow
Damping	Enter time constant for input damping (PT1 element). Damping reduces the effect of fluctuations in the measured value on the output signal.	Positive floating-point number

10.5.6 Displaying the I/O configuration

The **I/O configuration** submenu guides the user systematically through all the parameters in which the configuration of the I/O modules is displayed.

Navigation

"Setup" menu → I/O configuration

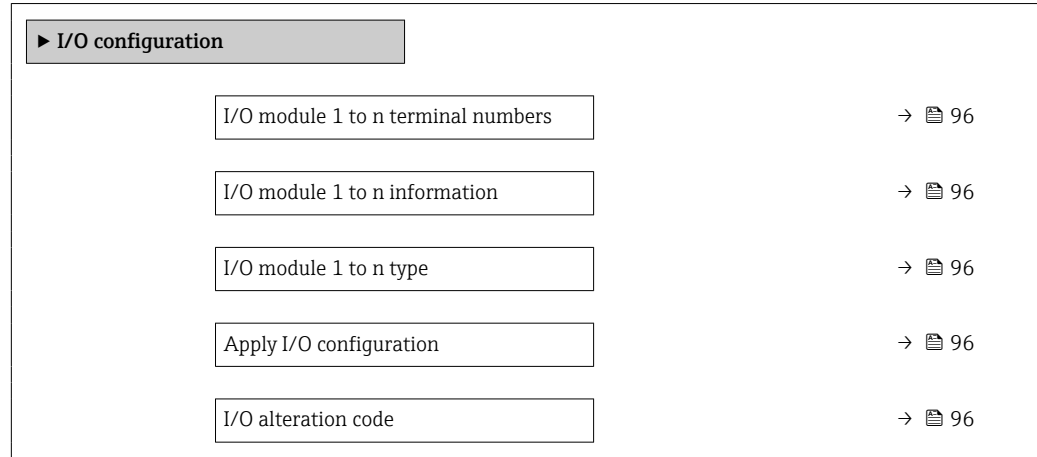

Parameter overview with brief description

Parameter	Description	User interface / Selection / User entry
I/O module 1 to n terminal numbers	Shows the terminal numbers used by the I/O module.	<ul style="list-style-type: none"> Not used 26-27 (I/O 1) 24-25 (I/O 2) 22-23 (I/O 3)
I/O module 1 to n information	Shows information of the plugged I/O module.	<ul style="list-style-type: none"> Not plugged Invalid Not configurable Configurable PROFINET
I/O module 1 to n type	Shows the I/O module type.	<ul style="list-style-type: none"> Off Current output * Current input * Status input * Pulse/frequency/switch output * Double pulse output * Relay output *
Apply I/O configuration	Apply parameterization of the freely configurable I/O module.	<ul style="list-style-type: none"> No Yes
I/O alteration code	Enter the code in order to change the I/O configuration.	Positive integer

* Visibility depends on order options or device settings





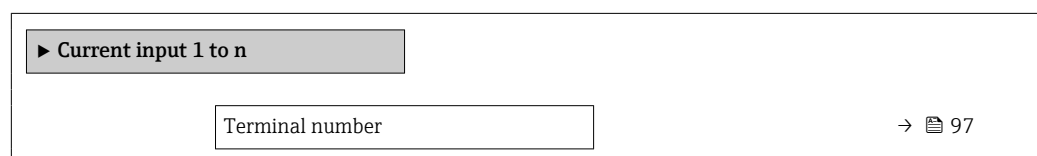

10.5.7 Configuring the current input

The "Current input" wizard guides the user systematically through all the parameters that have to be set for configuring the current input.

Navigation

"Setup" menu → Current input



Signal mode	→  97
0/4 mA value	→  97
20 mA value	→  97
Current span	→  97
Failure mode	→  97
Failure value	→  97

Parameter overview with brief description

Parameter	Prerequisite	Description	User interface / Selection / User entry	Factory setting
Terminal number	–	Shows the terminal numbers used by the current input module.	<ul style="list-style-type: none"> ▪ Not used ▪ 24-25 (I/O 2) ▪ 22-23 (I/O 3) 	–
Signal mode	The measuring device is not approved for use in the hazardous area with type of protection Ex-i.	Select the signal mode for the current input.	<ul style="list-style-type: none"> ▪ Passive ▪ Active * 	Active
0/4 mA value	–	Enter 4 mA value.	Signed floating-point number	–
20 mA value	–	Enter 20 mA value.	Signed floating-point number	Depends on country and nominal diameter
Current span	–	Select current range for process value output and upper/lower level for alarm signal.	<ul style="list-style-type: none"> ▪ 4...20 mA (4...20.5 mA) ▪ 4...20 mA NAMUR (3.8...20.5 mA) ▪ 4...20 mA US (3.9...20.8 mA) ▪ 0...20 mA (0...20.5 mA) 	Country-specific: <ul style="list-style-type: none"> ▪ 4...20 mA NAMUR (3.8...20.5 mA) ▪ 4...20 mA US (3.9...20.8 mA)
Failure mode	–	Define input behavior in alarm condition.	<ul style="list-style-type: none"> ▪ Alarm ▪ Last valid value ▪ Defined value 	–
Failure value	In the Failure mode parameter, the Defined value option is selected.	Enter value to be used by the device if input value from external device is missing.	Signed floating-point number	–

* Visibility depends on order options or device settings

10.5.8 Configuring the status input

The **Status input** submenu guides the user systematically through all the parameters that have to be set for configuring the status input.

Navigation

"Setup" menu → Status input 1 to n

▶ Status input 1 to n

Assign status input	→ 98
Terminal number	→ 98
Active level	→ 98
Terminal number	→ 98
Response time status input	→ 98
Terminal number	→ 98

Parameter overview with brief description

Parameter	Description	Selection / User interface / User entry
Assign status input	Select function for the status input.	<ul style="list-style-type: none"> ▪ Off ▪ Reset totalizer 1 ▪ Reset totalizer 2 ▪ Reset totalizer 3 ▪ Reset all totalizers ▪ Flow override ▪ Zero point adjustment
Terminal number	Shows the terminal numbers used by the status input module.	<ul style="list-style-type: none"> ▪ Not used ▪ 24-25 (I/O 2) ▪ 22-23 (I/O 3)
Active level	Define input signal level at which the assigned function is triggered.	<ul style="list-style-type: none"> ▪ High ▪ Low
Response time status input	Define the minimum amount of time the input signal level must be present before the selected function is triggered.	5 to 200 ms

10.5.9 Configuring the current output







The **Current output** wizard guides you systematically through all the parameters that have to be set for configuring the current output.

Navigation

"Setup" menu → Current output

▶ Current output 1 to n







Terminal number	→ 99
Signal mode	→ 99
Assign current output 1 to n	→ 100

Current span	→  100
0/4 mA value	→  100
20 mA value	→  101
Fixed current	→  101
Damping output 1 to n	→  101
Failure mode	→  101
Failure current	→  101

Parameter overview with brief description

Parameter	Prerequisite	Description	User interface / Selection / User entry	Factory setting
Terminal number	-	Shows the terminal numbers used by the current output module.	<ul style="list-style-type: none"> ■ Not used ■ 24-25 (I/O 2) ■ 22-23 (I/O 3) 	-
Signal mode	-	Select the signal mode for the current output.	<ul style="list-style-type: none"> ■ Active * ■ Passive * 	Active

Parameter	Prerequisite	Description	User interface / Selection / User entry	Factory setting
Assign current output 1 to n	–	Select process variable for current output.	<ul style="list-style-type: none"> ▪ Off* ▪ Mass flow ▪ Volume flow ▪ Corrected volume flow* ▪ Target mass flow* ▪ Carrier mass flow* ▪ Target volume flow* ▪ Carrier volume flow* ▪ Target corrected volume flow* ▪ Carrier corrected volume flow* ▪ Density ▪ Reference density* ▪ Concentration* ▪ Temperature ▪ Carrier pipe temperature* ▪ Electronic temperature ▪ Oscillation frequency 0 ▪ Oscillation amplitude 0* ▪ Frequency fluctuation 0* ▪ Oscillation damping 0* ▪ Oscillation damping fluctuation 0* ▪ Signal asymmetry* ▪ Exciter current 0* ▪ HBSI* ▪ Pressure* ▪ Application specific output 0* ▪ Application specific output 1* ▪ Index inhomogeneous medium ▪ Index suspended bubbles* 	–
Current span	–	Select current range for process value output and upper/lower level for alarm signal.	<ul style="list-style-type: none"> ▪ 4...20 mA NAMUR (3.8...20.5 mA) ▪ 4...20 mA US (3.9...20.8 mA) ▪ 4...20 mA (4...20.5 mA) ▪ 0...20 mA (0...20.5 mA) ▪ Fixed current 	Depends on country: <ul style="list-style-type: none"> ▪ 4...20 mA NAMUR (3.8...20.5 mA) ▪ 4...20 mA US (3.9...20.8 mA)
0/4 mA value	In Current span parameter (→  100), one of the following options is selected: <ul style="list-style-type: none"> ▪ 4...20 mA NAMUR (3.8...20.5 mA) ▪ 4...20 mA US (3.9...20.8 mA) ▪ 4...20 mA (4...20.5 mA) ▪ 0...20 mA (0...20.5 mA) 	Enter 4 mA value.	Signed floating-point number	Depends on country: <ul style="list-style-type: none"> ▪ 0 kg/h ▪ 0 lb/min

Parameter	Prerequisite	Description	User interface / Selection / User entry	Factory setting
20 mA value	In Current span parameter (→  100), one of the following options is selected: <ul style="list-style-type: none"> ▪ 4...20 mA NAMUR (3.8...20.5 mA) ▪ 4...20 mA US (3.9...20.8 mA) ▪ 4...20 mA (4... 20.5 mA) ▪ 0...20 mA (0... 20.5 mA) 	Enter 20 mA value.	Signed floating-point number	Depends on country and nominal diameter
Fixed current	The Fixed current option is selected in the Current span parameter (→  100).	Defines the fixed output current.	0 to 22.5 mA	22.5 mA
Damping output 1 to n	A process variable is selected in the Assign current output parameter (→  100) and one of the following options is selected in the Current span parameter (→  100): <ul style="list-style-type: none"> ▪ 4...20 mA NAMUR (3.8...20.5 mA) ▪ 4...20 mA US (3.9...20.8 mA) ▪ 4...20 mA (4... 20.5 mA) ▪ 0...20 mA (0... 20.5 mA) 	Set reaction time for output signal to fluctuations in the measured value.	0.0 to 999.9 s	–
Failure mode	A process variable is selected in the Assign current output parameter (→  100) and one of the following options is selected in the Current span parameter (→  100): <ul style="list-style-type: none"> ▪ 4...20 mA NAMUR (3.8...20.5 mA) ▪ 4...20 mA US (3.9...20.8 mA) ▪ 4...20 mA (4... 20.5 mA) ▪ 0...20 mA (0... 20.5 mA) 	Define output behavior in alarm condition.	<ul style="list-style-type: none"> ▪ Min. ▪ Max. ▪ Last valid value ▪ Actual value ▪ Defined value 	–
Failure current	The Defined value option is selected in the Failure mode parameter.	Enter current output value in alarm condition.	0 to 22.5 mA	22.5 mA

* Visibility depends on order options or device settings

10.5.10 Configuring the pulse/frequency/switch output

The **Pulse/frequency/switch output** wizard guides you systematically through all the parameters that can be set for configuring the selected output type.

Navigation

"Setup" menu → Advanced setup → Pulse/frequency/switch output

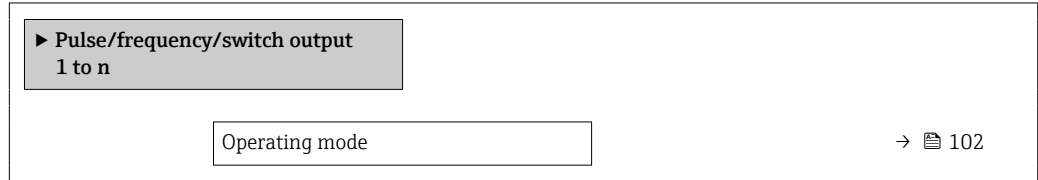

Parameter overview with brief description

Parameter	Description	Selection
Operating mode	Define the output as a pulse, frequency or switch output.	<ul style="list-style-type: none"> ■ Pulse ■ Frequency ■ Switch

Configuring the pulse output

Navigation

"Setup" menu → Pulse/frequency/switch output

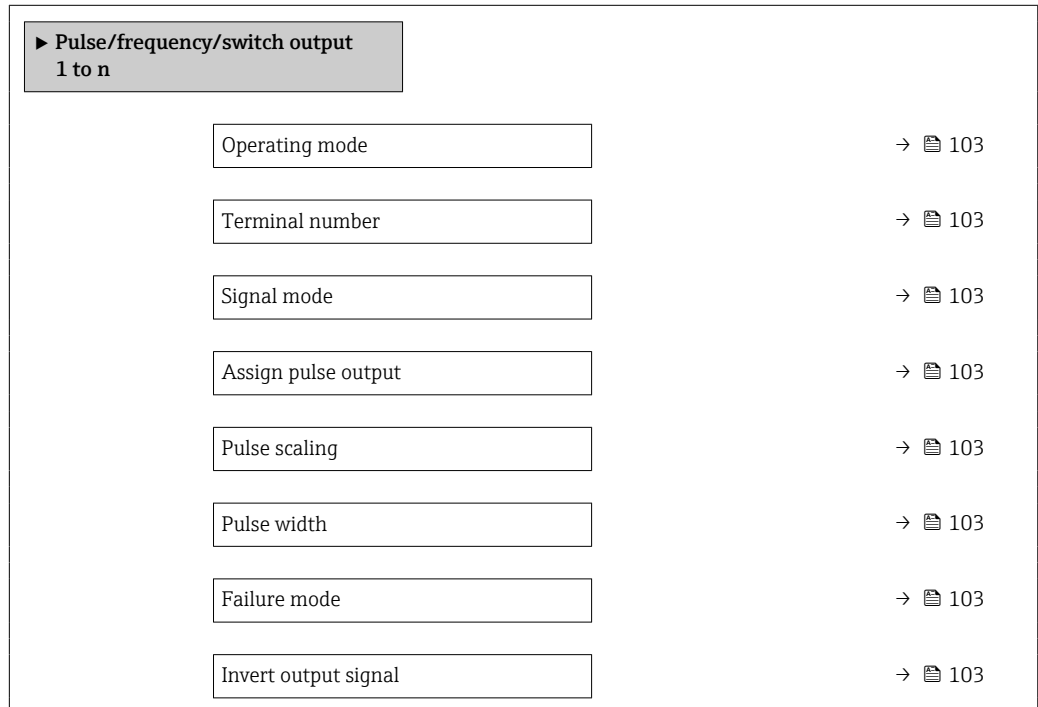

Parameter overview with brief description

Parameter	Prerequisite	Description	Selection / User interface / User entry	Factory setting
Operating mode	–	Define the output as a pulse, frequency or switch output.	<ul style="list-style-type: none"> ■ Pulse ■ Frequency ■ Switch 	–
Terminal number	–	Shows the terminal numbers used by the PFS output module.	<ul style="list-style-type: none"> ■ Not used ■ 24-25 (I/O 2) ■ 22-23 (I/O 3) 	–
Signal mode	–	Select the signal mode for the PFS output.	<ul style="list-style-type: none"> ■ Passive ■ Active ■ Passive NAMUR 	–
Assign pulse output 1 to n	The Pulse option is selected in the Operating mode parameter.	Select process variable for pulse output.	<ul style="list-style-type: none"> ■ Off ■ Mass flow ■ Volume flow ■ Corrected volume flow[*] ■ Target mass flow[*] ■ Carrier mass flow[*] ■ Target volume flow[*] ■ Carrier volume flow[*] ■ Target corrected volume flow[*] ■ Carrier corrected volume flow[*] 	–
Pulse scaling	The Pulse option is selected in the Operating mode parameter (→ 102) and a process variable is selected in the Assign pulse output parameter (→ 103).	Enter quantity for measured value at which a pulse is output.	Positive floating point number	Depends on country and nominal diameter
Pulse width	The Pulse option is selected in the Operating mode parameter (→ 102) and a process variable is selected in the Assign pulse output parameter (→ 103).	Define time width of the output pulse.	0.05 to 2000 ms	–
Failure mode	The Pulse option is selected in the Operating mode parameter (→ 102) and a process variable is selected in the Assign pulse output parameter (→ 103).	Define output behavior in alarm condition.	<ul style="list-style-type: none"> ■ Actual value ■ No pulses 	–
Invert output signal	–	Invert the output signal.	<ul style="list-style-type: none"> ■ No ■ Yes 	–

* Visibility depends on order options or device settings

Configuring the frequency output





Navigation









"Setup" menu → Pulse/frequency/switch output

► Pulse/frequency/switch output 1 to n	
Operating mode	→ 104
Terminal number	→ 104
Signal mode	→ 104
Assign frequency output	→ 105
Minimum frequency value	→ 105
Maximum frequency value	→ 105
Measuring value at minimum frequency	→ 106
Measuring value at maximum frequency	→ 106
Failure mode	→ 106
Failure frequency	→ 106
Invert output signal	→ 106

Parameter overview with brief description

Parameter	Prerequisite	Description	Selection / User interface / User entry	Factory setting
Operating mode	–	Define the output as a pulse, frequency or switch output.	<ul style="list-style-type: none"> ▪ Pulse ▪ Frequency ▪ Switch 	–
Terminal number	–	Shows the terminal numbers used by the PFS output module.	<ul style="list-style-type: none"> ▪ Not used ▪ 24-25 (I/O 2) ▪ 22-23 (I/O 3) 	–
Signal mode	–	Select the signal mode for the PFS output.	<ul style="list-style-type: none"> ▪ Passive ▪ Active ▪ Passive NAMUR 	–

Parameter	Prerequisite	Description	Selection / User interface / User entry	Factory setting
Assign frequency output	The Frequency option is selected in Operating mode parameter (→  102).	Select process variable for frequency output.	<ul style="list-style-type: none"> ▪ Off ▪ Mass flow ▪ Volume flow ▪ Corrected volume flow * ▪ Density ▪ Reference density * ▪ Temperature ▪ Pressure ▪ Concentration * ▪ Target mass flow * ▪ Carrier mass flow * ▪ Target volume flow * ▪ Carrier volume flow * ▪ Target corrected volume flow * ▪ Carrier corrected volume flow * ▪ Application specific output 0 * ▪ Application specific output 1 * ▪ HBSI * ▪ Exciter current 0 ▪ Oscillation damping 0 ▪ Oscillation damping fluctuation 0 * ▪ Oscillation frequency 0 ▪ Frequency fluctuation 0 * ▪ Oscillation amplitude 0 * ▪ Signal asymmetry ▪ Carrier pipe temperature * ▪ Electronic temperature ▪ Index inhomogeneous medium ▪ Index suspended bubbles * 	–
Minimum frequency value	The Frequency option is selected in the Operating mode parameter (→  102) and a process variable is selected in the Assign frequency output parameter (→  105).	Enter minimum frequency.	0.0 to 10000.0 Hz	–
Maximum frequency value	The Frequency option is selected in the Operating mode parameter (→  102) and a process variable is selected in the Assign frequency output parameter (→  105).	Enter maximum frequency.	0.0 to 10000.0 Hz	–

Parameter	Prerequisite	Description	Selection / User interface / User entry	Factory setting
Measuring value at minimum frequency	The Frequency option is selected in the Operating mode parameter (→  102) and a process variable is selected in the Assign frequency output parameter (→  105).	Enter measured value for minimum frequency.	Signed floating-point number	Depends on country and nominal diameter
Measuring value at maximum frequency	The Frequency option is selected in the Operating mode parameter (→  102) and a process variable is selected in the Assign frequency output parameter (→  105).	Enter measured value for maximum frequency.	Signed floating-point number	Depends on country and nominal diameter
Failure mode	The Frequency option is selected in the Operating mode parameter (→  102) and a process variable is selected in the Assign frequency output parameter (→  105).	Define output behavior in alarm condition.	<ul style="list-style-type: none"> ▪ Actual value ▪ Defined value ▪ 0 Hz 	–
Failure frequency	In the Operating mode parameter (→  102), the Frequency option is selected, in the Assign frequency output parameter (→  105) a process variable is selected, and in the Failure mode parameter, the Defined value option is selected.	Enter frequency output value in alarm condition.	0.0 to 12 500.0 Hz	–
Invert output signal	–	Invert the output signal.	<ul style="list-style-type: none"> ▪ No ▪ Yes 	–

* Visibility depends on order options or device settings

Configuring the switch output

Navigation

"Setup" menu → Pulse/frequency/switch output

► Pulse/frequency/switch output 1 to n	
Operating mode	→ 107
Terminal number	→ 107
Signal mode	→ 107
Switch output function	→ 108
Assign diagnostic behavior	→ 108
Assign limit	→ 108
Assign flow direction check	→ 108
Assign status	→ 108
Switch-on value	→ 109
Switch-off value	→ 109
Switch-on delay	→ 109
Switch-off delay	→ 109
Failure mode	→ 109
Invert output signal	→ 109

Parameter overview with brief description

Parameter	Prerequisite	Description	Selection / User interface / User entry	Factory setting
Operating mode	–	Define the output as a pulse, frequency or switch output.	<ul style="list-style-type: none"> ■ Pulse ■ Frequency ■ Switch 	–
Terminal number	–	Shows the terminal numbers used by the PFS output module.	<ul style="list-style-type: none"> ■ Not used ■ 24-25 (I/O 2) ■ 22-23 (I/O 3) 	–
Signal mode	–	Select the signal mode for the PFS output.	<ul style="list-style-type: none"> ■ Passive ■ Active ■ Passive NAMUR 	–

Parameter	Prerequisite	Description	Selection / User interface / User entry	Factory setting
Switch output function	The Switch option is selected in the Operating mode parameter.	Select function for switch output.	<ul style="list-style-type: none"> ▪ Off ▪ On ▪ Diagnostic behavior ▪ Limit ▪ Flow direction check ▪ Status 	–
Assign diagnostic behavior	<ul style="list-style-type: none"> ▪ In the Operating mode parameter, the Switch option is selected. ▪ In the Switch output function parameter, the Diagnostic behavior option is selected. 	Select diagnostic behavior for switch output.	<ul style="list-style-type: none"> ▪ Alarm ▪ Alarm or warning ▪ Warning 	–
Assign limit	<ul style="list-style-type: none"> ▪ The Switch option is selected in Operating mode parameter. ▪ The Limit option is selected in Switch output function parameter. 	Select process variable for limit function.	<ul style="list-style-type: none"> ▪ Mass flow ▪ Volume flow ▪ Corrected volume flow[*] ▪ Target mass flow[*] ▪ Carrier mass flow[*] ▪ Target volume flow[*] ▪ Carrier volume flow[*] ▪ Target corrected volume flow[*] ▪ Carrier corrected volume flow[*] ▪ Density ▪ Reference density[*] ▪ Concentration[*] ▪ Temperature ▪ Totalizer 1 ▪ Totalizer 2 ▪ Totalizer 3 ▪ Oscillation damping ▪ Pressure ▪ Application specific output 0[*] ▪ Application specific output 1[*] ▪ Index inhomogeneous medium ▪ Index suspended bubbles[*] 	–
Assign flow direction check	<ul style="list-style-type: none"> ▪ The Switch option is selected in the Operating mode parameter. ▪ The Flow direction check option is selected in the Switch output function parameter. 	Select process variable for flow direction monitoring.		–
Assign status	<ul style="list-style-type: none"> ▪ The Switch option is selected in Operating mode parameter. ▪ The Status option is selected in Switch output function parameter. 	Select device status for switch output.	<ul style="list-style-type: none"> ▪ Partially filled pipe detection ▪ Low flow cut off[*] ▪ Profinet Slot 24[*] ▪ Profinet Slot 25[*] ▪ Profinet Slot 26[*] 	–

Parameter	Prerequisite	Description	Selection / User interface / User entry	Factory setting
Switch-on value	<ul style="list-style-type: none"> The Switch option is selected in the Operating mode parameter. The Limit option is selected in the Switch output function parameter. 	Enter measured value for the switch-on point.	Signed floating-point number	Depends on country: <ul style="list-style-type: none"> 0 kg/h 0 lb/min
Switch-off value	<ul style="list-style-type: none"> The Switch option is selected in the Operating mode parameter. The Limit option is selected in the Switch output function parameter. 	Enter measured value for the switch-off point.	Signed floating-point number	Depends on country: <ul style="list-style-type: none"> 0 kg/h 0 lb/min
Switch-on delay	<ul style="list-style-type: none"> The Switch option is selected in the Operating mode parameter. The Limit option is selected in the Switch output function parameter. 	Define delay for the switch-on of status output.	0.0 to 100.0 s	–
Switch-off delay	<ul style="list-style-type: none"> The Switch option is selected in the Operating mode parameter. The Limit option is selected in the Switch output function parameter. 	Define delay for the switch-off of status output.	0.0 to 100.0 s	–
Failure mode	–	Define output behavior in alarm condition.	<ul style="list-style-type: none"> Actual status Open Closed 	–
Invert output signal	–	Invert the output signal.	<ul style="list-style-type: none"> No Yes 	–

* Visibility depends on order options or device settings

10.5.11 Configuring the relay output







The **Relay output** wizard guides the user systematically through all the parameters that have to be set for configuring the relay output.

Navigation

"Setup" menu → Relay output 1 to n

▶ **Relay output 1 to n**

Terminal number	→ ⓘ 110
Relay output function	→ ⓘ 110
Assign flow direction check	→ ⓘ 110
Assign limit	→ ⓘ 111
Assign diagnostic behavior	→ ⓘ 111
Assign status	→ ⓘ 111

Switch-off value	→  111
Switch-off delay	→  111
Switch-on value	→  111
Switch-on delay	→  111
Failure mode	→  111
Switch status	→  112
Powerless relay status	→  112

Parameter overview with brief description

Parameter	Prerequisite	Description	User interface / Selection / User entry	Factory setting
Terminal number	–	Shows the terminal numbers used by the relay output module.	<ul style="list-style-type: none"> ▪ Not used ▪ 24-25 (I/O 2) ▪ 22-23 (I/O 3) 	–
Relay output function	–	Select the function for the relay output.	<ul style="list-style-type: none"> ▪ Closed ▪ Open ▪ Diagnostic behavior ▪ Limit ▪ Flow direction check ▪ Digital Output 	–
Assign flow direction check	The Flow direction check option is selected in the Relay output function parameter.	Select process variable for flow direction monitoring.		–

Parameter	Prerequisite	Description	User interface / Selection / User entry	Factory setting
Assign limit	The Limit option is selected in Relay output function parameter.	Select process variable for limit function.	<ul style="list-style-type: none"> ■ Mass flow ■ Volume flow ■ Corrected volume flow[*] ■ Target mass flow[*] ■ Carrier mass flow[*] ■ Target volume flow[*] ■ Carrier volume flow[*] ■ Target corrected volume flow[*] ■ Carrier corrected volume flow[*] ■ Density ■ Reference density[*] ■ Concentration[*] ■ Temperature ■ Totalizer 1 ■ Totalizer 2 ■ Totalizer 3 ■ Oscillation damping ■ Pressure ■ Application specific output 0[*] ■ Application specific output 1[*] ■ Index inhomogeneous medium ■ Index suspended bubbles[*] 	–
Assign diagnostic behavior	In the Relay output function parameter, the Diagnostic behavior option is selected.	Select diagnostic behavior for switch output.	<ul style="list-style-type: none"> ■ Alarm ■ Alarm or warning ■ Warning 	–
Assign status	In the Relay output function parameter, the Digital Output option is selected.	Select device status for switch output.	<ul style="list-style-type: none"> ■ Partially filled pipe detection ■ Low flow cut off ■ Profinet Slot 24[*] ■ Profinet Slot 25[*] ■ Profinet Slot 26[*] 	–
Switch-off value	The Limit option is selected in the Relay output function parameter.	Enter measured value for the switch-off point.	Signed floating-point number	Depends on country: <ul style="list-style-type: none"> ■ 0 kg/h ■ 0 lb/min
Switch-off delay	In the Relay output function parameter, the Limit option is selected.	Define delay for the switch-off of status output.	0.0 to 100.0 s	–
Switch-on value	The Limit option is selected in the Relay output function parameter.	Enter measured value for the switch-on point.	Signed floating-point number	Depends on country: <ul style="list-style-type: none"> ■ 0 kg/h ■ 0 lb/min
Switch-on delay	In the Relay output function parameter, the Limit option is selected.	Define delay for the switch-on of status output.	0.0 to 100.0 s	–
Failure mode	–	Define output behavior in alarm condition.	<ul style="list-style-type: none"> ■ Actual status ■ Open ■ Closed 	–

Parameter	Prerequisite	Description	User interface / Selection / User entry	Factory setting
Switch status	–	Shows the current relay switch status.	<ul style="list-style-type: none"> ▪ Open ▪ Closed 	–
Powerless relay status	–	Select quietscent state for relay.	<ul style="list-style-type: none"> ▪ Open ▪ Closed 	–









* Visibility depends on order options or device settings

10.5.12 Configuring the local display

The **Display** wizard guides you systematically through all the parameters that can be configured for configuring the local display.

Navigation

"Setup" menu → Display

► Display	
Format display	→  113
Value 1 display	→  113
0% bargraph value 1	→  114
100% bargraph value 1	→  114
Value 2 display	→  114
Value 3 display	→  114
0% bargraph value 3	→  114
100% bargraph value 3	→  114
Value 4 display	→  114

Parameter overview with brief description

Parameter	Prerequisite	Description	Selection / User entry	Factory setting
Format display	A local display is provided.	Select how measured values are shown on the display.	<ul style="list-style-type: none"> ■ 1 value, max. size ■ 1 bargraph + 1 value ■ 2 values ■ 1 value large + 2 values ■ 4 values 	–
Value 1 display	A local display is provided.	Select the measured value that is shown on the local display.	<ul style="list-style-type: none"> ■ Mass flow ■ Volume flow ■ Corrected volume flow * ■ Density ■ Reference density * ■ Temperature ■ Current output 1 * ■ Current output 2 * ■ Current output 4 * ■ Pressure ■ Totalizer 1 ■ Totalizer 2 ■ Totalizer 3 ■ Concentration * ■ Target mass flow * ■ Carrier mass flow * ■ Target volume flow * ■ Carrier volume flow * ■ Target corrected volume flow * ■ Carrier corrected volume flow * ■ Current output 1 * ■ Current output 2 * ■ Current output 4 * ■ Index inhomogeneous medium ■ Application specific output 0 * ■ Application specific output 1 * ■ HBSI * ■ Exciter current 0 ■ Oscillation damping 0 ■ Oscillation damping fluctuation 0 * ■ Oscillation frequency 0 ■ Frequency fluctuation 0 * ■ Oscillation amplitude 0 * ■ Signal asymmetry ■ Carrier pipe temperature * ■ Electronic temperature ■ Current output 1 * ■ Current output 2 * ■ Current output 3 * ■ Index suspended bubbles * 	–

Parameter	Prerequisite	Description	Selection / User entry	Factory setting
0% bargraph value 1	A local display is provided.	Enter 0% value for bar graph display.	Signed floating-point number	Country-specific: <ul style="list-style-type: none"> ■ 0 kg/h ■ 0 lb/min
100% bargraph value 1	A local display is provided.	Enter 100% value for bar graph display.	Signed floating-point number	Depends on country and nominal diameter
Value 2 display	A local display is provided.	Select the measured value that is shown on the local display.	For the picklist, see Value 1 display parameter (→ 113)	–
Value 3 display	A local display is provided.	Select the measured value that is shown on the local display.	For the picklist, see Value 1 display parameter (→ 113)	–
0% bargraph value 3	A selection was made in the Value 3 display parameter.	Enter 0% value for bar graph display.	Signed floating-point number	Country-specific: <ul style="list-style-type: none"> ■ 0 kg/h ■ 0 lb/min
100% bargraph value 3	A selection was made in the Value 3 display parameter.	Enter 100% value for bar graph display.	Signed floating-point number	–
Value 4 display	A local display is provided.	Select the measured value that is shown on the local display.	For the picklist, see Value 1 display parameter (→ 113)	–
Value 5 display	A local display is provided.	Select the measured value that is shown on the local display.	For the picklist, see Value 1 display parameter (→ 113)	–
Value 6 display	A local display is provided.	Select the measured value that is shown on the local display.	For the picklist, see Value 1 display parameter (→ 113)	–
Value 7 display	A local display is provided.	Select the measured value that is shown on the local display.	For the picklist, see Value 1 display parameter (→ 113)	–
Value 8 display	A local display is provided.	Select the measured value that is shown on the local display.	For the picklist, see Value 1 display parameter (→ 113)	–

* Visibility depends on order options or device settings

10.5.13 Configuring the low flow cut off

The **Low flow cut off** wizard systematically guides the user through all the parameters that must be set to configure low flow cut off.

Navigation

"Setup" menu → Low flow cut off

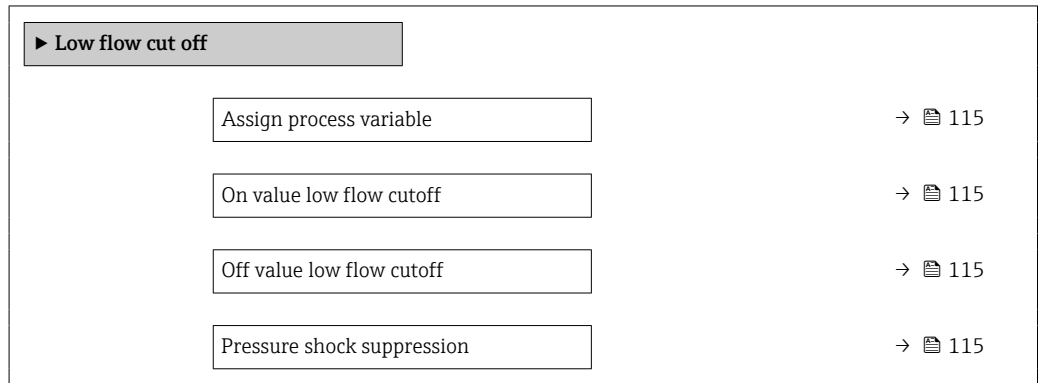

Parameter overview with brief description

Parameter	Prerequisite	Description	Selection / User entry	Factory setting
Assign process variable	–	Select process variable for low flow cut off.	<ul style="list-style-type: none"> ■ Off ■ Mass flow ■ Volume flow ■ Corrected volume flow[*] 	–
On value low flow cutoff	A process variable is selected in the Assign process variable parameter (→ 115).	Enter on value for low flow cut off.	Positive floating-point number	Depends on country and nominal diameter
Off value low flow cutoff	A process variable is selected in the Assign process variable parameter (→ 115).	Enter off value for low flow cut off.	0 to 100.0 %	–
Pressure shock suppression	A process variable is selected in the Assign process variable parameter (→ 115).	Enter time frame for signal suppression (= active pressure shock suppression).	0 to 100 s	–

* Visibility depends on order options or device settings

10.5.14 Configuring partially filled pipe detection

The **Partial filled pipe detection** wizard guides you systematically through all parameters that have to be set for configuring the monitoring of the pipe filling.

Navigation

"Setup" menu → Partially filled pipe detection

▶ Partially filled pipe detection	
Assign process variable	→ ⓘ 116
Low value partial filled pipe detection	→ ⓘ 116
High value partial filled pipe detection	→ ⓘ 116
Response time part. filled pipe detect.	→ ⓘ 116

Parameter overview with brief description

Parameter	Prerequisite	Description	Selection / User entry	Factory setting
Assign process variable	–	Select process variable for partially filled pipe detection.	<ul style="list-style-type: none"> ■ Off ■ Density ■ Reference density 	Density
Low value partial filled pipe detection	A process variable is selected in the Assign process variable parameter (→ ⓘ 116).	Enter lower limit value for deactivating partially filled pipe detection.	Signed floating-point number	Depends on country: <ul style="list-style-type: none"> ■ 200 kg/m³ ■ 12.5 lb/ft³
High value partial filled pipe detection	A process variable is selected in the Assign process variable parameter (→ ⓘ 116).	Enter upper limit value for deactivating partially filled pipe detection.	Signed floating-point number	Depends on country: <ul style="list-style-type: none"> ■ 6 000 kg/m³ ■ 374.6 lb/ft³
Response time part. filled pipe detect.	A process variable is selected in the Assign process variable parameter (→ ⓘ 116).	Use this function to enter the minimum time (hold time) the signal must be present before diagnostic message S962 "Pipe only partly filled" is triggered in the event of a partially filled or empty measuring pipe.	0 to 100 s	–

10.6 Advanced settings

The **Advanced setup** submenu with its submenus contains parameters for specific settings.

Navigation to the "Advanced setup" submenu

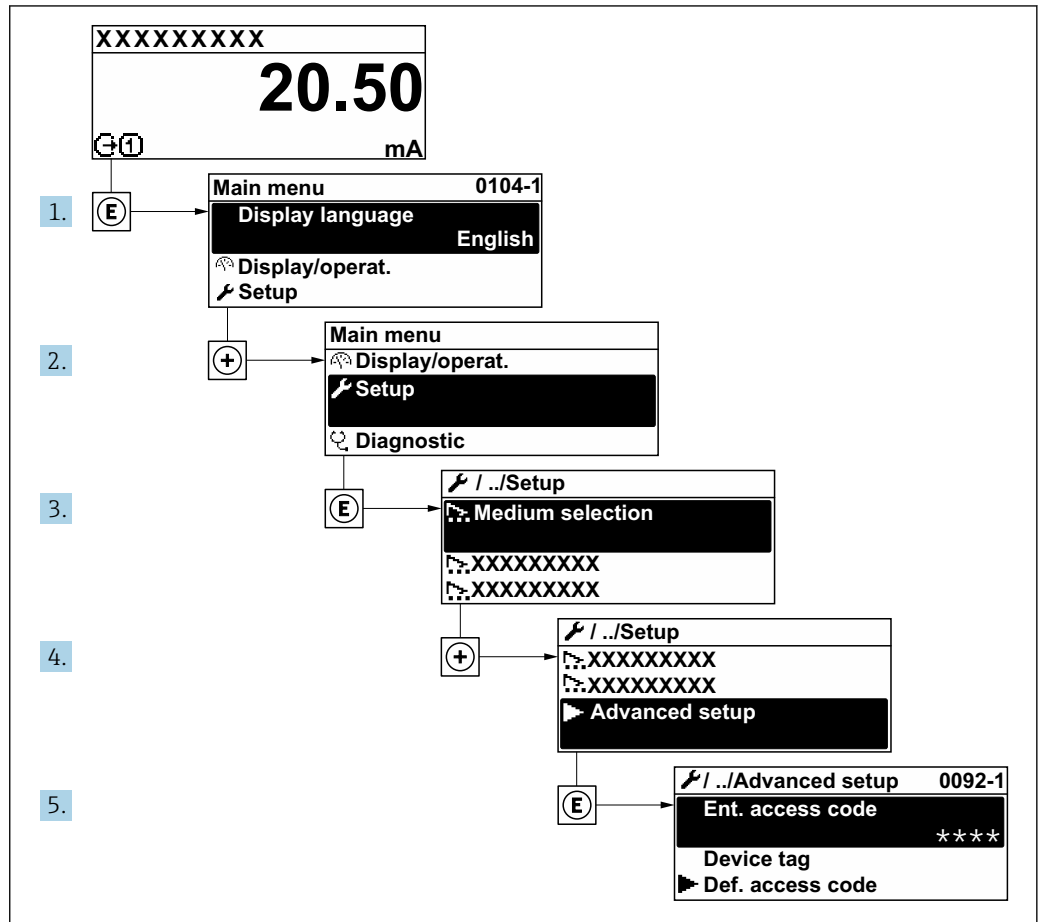

A003223-EN

i The number of submenus and parameters can vary depending on the device version and the available application packages. These submenus and their parameters are explained in the Special Documentation for the device and not in Operating Instructions.

For detailed information on the parameter descriptions for application packages: Special Documentation for the device → 259

Navigation

"Setup" menu → Advanced setup

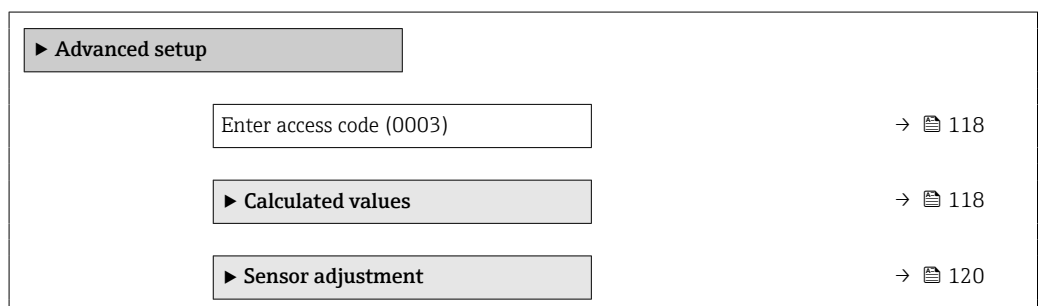

▶ Totalizer 1 to n	→ 126
▶ Display	→ 128
▶ WLAN settings	→ 131
▶ Viscosity	→ 133
▶ Concentration	→ 133
▶ Petroleum	→ 133
▶ Heartbeat setup	→ 133
▶ Configuration backup	→ 134
▶ Administration	→ 135

10.6.1 Using the parameter to enter the access code

Navigation

"Setup" menu → Advanced setup

Parameter overview with brief description

Parameter	Description	User entry
Enter access code	Enter access code to disable write protection of parameters.	Max. 16-digit character string comprising numbers, letters and special characters

10.6.2 Calculated process variables

The **Calculated values** submenu contains parameters for calculating the corrected volume flow.

Navigation

"Setup" menu → Advanced setup → Calculated values

▶ Calculated values	
▶ Corrected volume flow calculation	→ 119

"Corrected volume flow calculation" submenu

Navigation

"Setup" menu → Advanced setup → Calculated values → Corrected volume flow calculation

▶ Corrected volume flow calculation	
Corrected volume flow calculation (1812)	→ 119
External reference density (6198)	→ 119
Fixed reference density (1814)	→ 119
Reference temperature (1816)	→ 119
Linear expansion coefficient (1817)	→ 120
Square expansion coefficient (1818)	→ 120

Parameter overview with brief description

Parameter	Prerequisite	Description	Selection / User interface / User entry	Factory setting
Corrected volume flow calculation	–	Select reference density for calculating the corrected volume flow.	<ul style="list-style-type: none"> ■ Fixed reference density ■ Calculated reference density ■ External reference density ■ Current input 1 * ■ Current input 2 * 	–
External reference density	In the Corrected volume flow calculation parameter, the External reference density option is selected.	Shows external reference density.	Floating point number with sign	–
Fixed reference density	The Fixed reference density option is selected in the Corrected volume flow calculation parameter.	Enter fixed value for reference density.	Positive floating-point number	–
Reference temperature	The Calculated reference density option is selected in the Corrected volume flow calculation parameter.	Enter reference temperature for calculating the reference density.	–273.15 to 99999 °C	Country-specific: <ul style="list-style-type: none"> ■ +20 °C ■ +68 °F

Parameter	Prerequisite	Description	Selection / User interface / User entry	Factory setting
Linear expansion coefficient	The Calculated reference density option is selected in the Corrected volume flow calculation parameter parameter.	Enter linear, medium-specific expansion coefficient for calculating the reference density.	Signed floating-point number	-
Square expansion coefficient	The Calculated reference density option is selected in the Corrected volume flow calculation parameter parameter.	For media with a non-linear expansion pattern: enter the quadratic, medium-specific expansion coefficient for calculating the reference density.	Signed floating-point number	-

* Visibility depends on order options or device settings

10.6.3 Carrying out a sensor adjustment

The **Sensor adjustment** submenu contains parameters that pertain to the functionality of the sensor.

Navigation

"Setup" menu → Advanced setup → Sensor adjustment

▶ Sensor adjustment	
Installation direction	→ ⓘ 120
▶ Density adjustment	
▶ Zero verification	→ ⓘ 124
▶ Zero adjustment	→ ⓘ 125

Parameter overview with brief description

Parameter	Description	Selection
Installation direction	Set sign of flow direction to match the direction of the arrow on the sensor.	<ul style="list-style-type: none"> ▪ Flow in arrow direction ▪ Flow against arrow direction

Density adjustment

 With density adjustment, a high level of accuracy is achieved only at the point of adjustment and at the relevant density and temperature. However, the accuracy of a density adjustment is only ever as good as the quality of the reference measuring data provided. Therefore it is not a substitute for special density calibration.

Performing density adjustment

Note the following before performing the adjustment:

- A density adjustment only makes sense if there is little variation in the operating conditions and the density adjustment is performed under the operating conditions.
- The density adjustment scales the internally computed density value with a user-specific slope and offset.
- A 1-point or 2-point density adjustment can be performed.
- For a 2-point density adjustment, there must be a difference of at least 0.2 kg/l between the two target density values.
- The reference media must be gas-free or pressurized so that any gas they contain is compressed.
- The reference density measurements must be performed at the same medium temperature that prevails in the process, as otherwise the density adjustment will not be accurate.
- The correction resulting from the density adjustment can be deleted with the **Restore original** option.

"1 point adjustment" option

1. In the **Density adjustment mode** parameter, select the **1 point adjustment** option and confirm.
2. In the **Density setpoint 1** parameter, enter the density value and confirm.
 - ↳ In the **Execute density adjustment** parameter the following options are now available:
 - Ok
 - Measure density 1 option**
 - Restore original
3. Select the **Measure density 1 option** and confirm.
4. If 100% was reached in the **Progress** parameter on the display and the **Ok** option is displayed in the **Execute density adjustment** parameter, then confirm.
 - ↳ In the **Execute density adjustment** parameter the following options are now available:
 - Ok
 - Calculate
 - Cancel
5. Select the **Calculate** option and confirm.

If the adjustment was completed successfully, the **Density adjustment factor** parameter and the **Density adjustment offset** parameter and the values calculated for them are shown on the display.

"2 point adjustment" option

1. In the **Density adjustment mode** parameter, select the **2 point adjustment** option and confirm.
2. In the **Density setpoint 1** parameter, enter the density value and confirm.
3. In the **Density setpoint 2** parameter, enter the density value and confirm.
 - ↳ In the **Execute density adjustment** parameter the following options are now available:
 - Ok
 - Measure density 1
 - Restore original

4. Select the **Measure density 1** option and confirm.
 - ↳ In the **Execute density adjustment** parameter the following options are now available:
 - Ok
 - Measure density 2
 - Restore original
5. Select the **Measure density 2** option and confirm.
 - ↳ In the **Execute density adjustment** parameter the following options are now available:
 - Ok
 - Calculate
 - Cancel
6. Select the **Calculate** option and confirm.

If the **Density adjust failure** option is displayed in the **Execute density adjustment** parameter, call up the options and select the **Cancel** option. The density adjustment is canceled and can be repeated.

If the adjustment was completed successfully, the **Density adjustment factor** parameter and the **Density adjustment offset** parameter and the values calculated for them are shown on the display.

Navigation

"Expert" menu → Sensor → Sensor adjustment → Density adjustment

► Density adjustment	
Density adjustment mode	→ ⓘ 122
Density setpoint 1	→ ⓘ 122
Density setpoint 2	→ ⓘ 123
Execute density adjustment	→ ⓘ 123
Progress	→ ⓘ 123
Density adjustment factor	→ ⓘ 123
Density adjustment offset	→ ⓘ 123

Parameter overview with brief description

Parameter	Prerequisite	Description	Selection / User entry / User interface	Factory setting
Density adjustment mode	–	Select the method for field density adjustment to correct the factory setting.	<ul style="list-style-type: none"> ▪ 1 point adjustment ▪ 2 point adjustment 	–
Density setpoint 1	–	Enter density for the first reference media.	The entry depends on the unit selected in the Density unit parameter (0555).	–

Parameter	Prerequisite	Description	Selection / User entry / User interface	Factory setting
Density setpoint 2	In the Density adjustment mode parameter, the 2 point adjustment option is selected.	Enter density for the second reference media.	The entry depends on the unit selected in the Density unit parameter (0555).	–
Execute density adjustment	–	Select the next step to be performed for the density adjustment.	<ul style="list-style-type: none"> ■ Cancel * ■ Busy * ■ Ok * ■ Density adjust failure * ■ Measure density 1 * ■ Measure density 2 * ■ Calculate * ■ Restore original * 	–
Progress	–	Shows the progress of the process.	0 to 100 %	–
Density adjustment factor	–	Shows the calculated correction factor for the density.	Signed floating-point number	–
Density adjustment offset	–	Showsthe calculated correction offset for the density.	Signed floating-point number	–

* Visibility depends on order options or device settings

Zero verification and zero adjustment

All measuring instruments are calibrated in accordance with state-of-the-art technology. Calibration takes place under reference conditions →  239. Therefore, a zero adjustment in the field is generally not required.

Experience shows that zero adjustment is advisable only in special cases:

- To achieve maximum measurement accuracy even with low flow rates.
- Under extreme process or operating conditions (e.g. very high process temperatures or very high-viscosity fluids).
- For gas applications with low pressure

 To achieve the highest possible measurement accuracy at low flow rates, the installation must protect the sensor from mechanical stresses during operation.

To get a representative zero point, ensure that:

- any flow in the device is prevented during the adjustment
- the process conditions (e.g. pressure, temperature) are stable and representative

Zero verification and zero adjustment cannot be performed if the following process conditions are present:

- Gas pockets
Ensure that the system has been sufficiently flushed with the medium. Repeat flushing can help to eliminate gas pockets
- Thermal circulation
In the event of temperature differences (e.g. between the measuring tube inlet and outlet section), induced flow can occur even if the valves are closed due to thermal circulation in the device
- Leaks at the valves
If the valves are not leak-tight, flow is not sufficiently prevented when determining the zero point

If these conditions cannot be avoided, it is advisable to keep the factory setting for the zero point.

Zero point verification

The zero point can be verified with the **Zero verification** wizard.

Navigation

"Setup" menu → Advanced setup → Sensor adjustment → Zero verification

► Zero verification	
Process conditions	→ 124
Progress	→ 124
Status	→ 124
Additional information	→ 124
Recommendation:	→ 124
Root cause	→ 125
Abort cause	→ 124
Zero point measured	→ 125
Zero point standard deviation	→ 125

Parameter overview with brief description

Parameter	Description	Selection / User interface	Factory setting
Process conditions	Ensure process conditions as follows.	<ul style="list-style-type: none"> ▪ Tubes are completely filled ▪ Process operational pressure applied ▪ No-flow conditions (closed valves) ▪ Process and ambient temperatures stable 	–
Progress	Shows the progress of the process.	0 to 100 %	–
Zero point adjustment status	Shows the status of the zero point adjustment.	<ul style="list-style-type: none"> ▪ Busy ▪ Zero point adjust failure ▪ Ok 	–
Additional information	Indicate whether to display additional information.	<ul style="list-style-type: none"> ▪ Hide ▪ Show 	–
Recommendation:	Indicates whether an adjustment is recommended. Only recommended if the measured zero point deviates significantly from the current zero point.	<ul style="list-style-type: none"> ▪ Do not adjust zero point ▪ Adjust zero point 	–
Abort cause	Indicates why the wizard was aborted.	<ul style="list-style-type: none"> ▪ Check process conditions! ▪ A technical issue has occurred 	–

Parameter	Description	Selection / User interface	Factory setting
Root cause	Shows the diagnostic and remedy.	<ul style="list-style-type: none"> ▪ Zero point too high. Ensure no-flow. ▪ Zero point is unstable. Ensure no-flow. ▪ Fluctuation high. Avoid 2-phase medium. 	-
Zero point measured	Shows the zero point measured for the adjustment.	Signed floating-point number	-
Zero point standard deviation	Shows the standard deviation of the zero point measured.	Positive floating-point number	-

Zero adjust

The zero point can be adjusted with the **Zero adjustment** wizard.

-  ▪ A zero point verification should be performed before a zero adjustment.
- The zero point can also be adjusted manually: Expert → Sensor → Calibration

Navigation

"Setup" menu → Advanced setup → Sensor adjustment → Zero adjustment

► Zero adjustment	
Process conditions	→ 126
Progress	→ 126
Status	→ 126
Root cause	→ 126
Abort cause	→ 126
Root cause	→ 126
Reliability of measured zero point	→ 126
Additional information	→ 126
Reliability of measured zero point	→ 126
Zero point measured	→ 126
Zero point standard deviation	→ 126
Select action	→ 126

Parameter overview with brief description

Parameter	Description	Selection / User interface	Factory setting
Process conditions	Ensure process conditions as follows.	<ul style="list-style-type: none"> ▪ Tubes are completely filled ▪ Process operational pressure applied ▪ No-flow conditions (closed valves) ▪ Process and ambient temperatures stable 	–
Progress	Shows the progress of the process.	0 to 100 %	–
Zero point adjustment status	Shows the status of the zero point adjustment.	<ul style="list-style-type: none"> ▪ Busy ▪ Zero point adjust failure ▪ Ok 	–
Abort cause	Indicates why the wizard was aborted.	<ul style="list-style-type: none"> ▪ Check process conditions! ▪ A technical issue has occurred 	–
Root cause	Shows the diagnostic and remedy.	<ul style="list-style-type: none"> ▪ Zero point too high. Ensure no-flow. ▪ Zero point is unstable. Ensure no-flow. ▪ Fluctuation high. Avoid 2-phase medium. 	–
Reliability of measured zero point	Indicates the reliability of the zero point measured.	<ul style="list-style-type: none"> ▪ Not done ▪ Good ▪ Uncertain 	–
Additional information	Indicate whether to display additional information.	<ul style="list-style-type: none"> ▪ Hide ▪ Show 	–
Zero point measured	Shows the zero point measured for the adjustment.	Signed floating-point number	–
Zero point standard deviation	Shows the standard deviation of the zero point measured.	Positive floating-point number	–
Select action	Select the zero point value to apply.	<ul style="list-style-type: none"> ▪ Keep current zero point ▪ Apply zero point measured* ▪ Apply factory zero point* 	–

* Visibility depends on order options or device settings

10.6.4 Configuring the totalizer

In the **"Totalizer 1 to n"** submenu, you can configure the specific totalizer.

Navigation

"Setup" menu → Advanced setup → Totalizer 1 to n

▶ Totalizer 1 to n	
Assign process variable	→ ⓘ 127
Unit totalizer	→ ⓘ 127
Totalizer operation mode	→ ⓘ 127
Failure mode	→ ⓘ 127

Parameter overview with brief description



















Parameter	Description	Selection	Factory setting
Assign process variable	Select process variable for totalizer.	<ul style="list-style-type: none"> ■ Volume flow ■ Mass flow ■ Corrected volume flow 	–
Unit totalizer	Select the unit for the process variable of the totalizer.	Unit choose list	Country-specific: <ul style="list-style-type: none"> ■ kg ■ lb
Totalizer operation mode	Select totalizer calculation mode.	<ul style="list-style-type: none"> ■ Net flow total ■ Forward flow total ■ Reverse flow total ■ Last valid value 	–
Failure mode	Define the totalizer behavior in the event of a device alarm.	<ul style="list-style-type: none"> ■ Stop ■ Actual value ■ Last valid value 	–

10.6.5 Carrying out additional display configurations

In the **Display** submenu you can set all the parameters associated with the configuration of the local display.



Navigation

"Setup" menu → Advanced setup → Display

► Display	
Format display	→  129
Value 1 display	→  129
0% bargraph value 1	→  130
100% bargraph value 1	→  130
Decimal places 1	→  130
Value 2 display	→  130
Decimal places 2	→  130
Value 3 display	→  130
0% bargraph value 3	→  130
100% bargraph value 3	→  130
Decimal places 3	→  130
Value 4 display	→  130
Decimal places 4	→  130
Display language	→  130
Display interval	→  131
Display damping	→  131
Header	→  131
Header text	→  131
Separator	→  131
Backlight	→  131

Parameter overview with brief description

Parameter	Prerequisite	Description	Selection / User entry	Factory setting
Format display	A local display is provided.	Select how measured values are shown on the display.	<ul style="list-style-type: none"> ■ 1 value, max. size ■ 1 bargraph + 1 value ■ 2 values ■ 1 value large + 2 values ■ 4 values 	–
Value 1 display	A local display is provided.	Select the measured value that is shown on the local display.	<ul style="list-style-type: none"> ■ Mass flow ■ Volume flow ■ Corrected volume flow * ■ Density ■ Reference density * ■ Temperature ■ Current output 1 * ■ Current output 2 * ■ Current output 4 * ■ Pressure ■ Totalizer 1 ■ Totalizer 2 ■ Totalizer 3 ■ Concentration * ■ Target mass flow * ■ Carrier mass flow * ■ Target volume flow * ■ Carrier volume flow * ■ Target corrected volume flow * ■ Carrier corrected volume flow * ■ Current output 1 * ■ Current output 2 * ■ Current output 4 * ■ Index inhomogeneous medium ■ Application specific output 0 * ■ Application specific output 1 * ■ HBSI * ■ Exciter current 0 ■ Oscillation damping 0 ■ Oscillation damping fluctuation 0 * ■ Oscillation frequency 0 ■ Frequency fluctuation 0 * ■ Oscillation amplitude 0 * ■ Signal asymmetry ■ Carrier pipe temperature * ■ Electronic temperature ■ Current output 1 * ■ Current output 2 * ■ Current output 3 * ■ Index suspended bubbles * 	–

Parameter	Prerequisite	Description	Selection / User entry	Factory setting
0% bargraph value 1	A local display is provided.	Enter 0% value for bar graph display.	Signed floating-point number	Country-specific: <ul style="list-style-type: none"> ▪ 0 kg/h ▪ 0 lb/min
100% bargraph value 1	A local display is provided.	Enter 100% value for bar graph display.	Signed floating-point number	Depends on country and nominal diameter
Decimal places 1	A measured value is specified in the Value 1 display parameter.	Select the number of decimal places for the display value.	<ul style="list-style-type: none"> ▪ x ▪ x.x ▪ x.xx ▪ x.xxx ▪ x.xxxx 	–
Value 2 display	A local display is provided.	Select the measured value that is shown on the local display.	For the picklist, see Value 1 display parameter (→  113)	–
Decimal places 2	A measured value is specified in the Value 2 display parameter.	Select the number of decimal places for the display value.	<ul style="list-style-type: none"> ▪ x ▪ x.x ▪ x.xx ▪ x.xxx ▪ x.xxxx 	–
Value 3 display	A local display is provided.	Select the measured value that is shown on the local display.	For the picklist, see Value 1 display parameter (→  113)	–
0% bargraph value 3	A selection was made in the Value 3 display parameter.	Enter 0% value for bar graph display.	Signed floating-point number	Country-specific: <ul style="list-style-type: none"> ▪ 0 kg/h ▪ 0 lb/min
100% bargraph value 3	A selection was made in the Value 3 display parameter.	Enter 100% value for bar graph display.	Signed floating-point number	–
Decimal places 3	A measured value is specified in the Value 3 display parameter.	Select the number of decimal places for the display value.	<ul style="list-style-type: none"> ▪ x ▪ x.x ▪ x.xx ▪ x.xxx ▪ x.xxxx 	–
Value 4 display	A local display is provided.	Select the measured value that is shown on the local display.	For the picklist, see Value 1 display parameter (→  113)	–
Decimal places 4	A measured value is specified in the Value 4 display parameter.	Select the number of decimal places for the display value.	<ul style="list-style-type: none"> ▪ x ▪ x.x ▪ x.xx ▪ x.xxx ▪ x.xxxx 	–
Display language	A local display is provided.	Set display language.	<ul style="list-style-type: none"> ▪ English ▪ Deutsch ▪ Français ▪ Español ▪ Italiano ▪ Nederlands ▪ Portuguesa ▪ Polski ▪ русский язык (Russian) ▪ Svenska ▪ Türkçe ▪ 中文 (Chinese) ▪ 日本語 (Japanese) ▪ 한국어 (Korean) ▪ tiếng Việt (Vietnamese) ▪ čeština (Czech) 	English (alternatively, the ordered language is preset in the device)

Parameter	Prerequisite	Description	Selection / User entry	Factory setting
Display interval	A local display is provided.	Set time measured values are shown on display if display alternates between values.	1 to 10 s	-
Display damping	A local display is provided.	Set display reaction time to fluctuations in the measured value.	0.0 to 999.9 s	-
Header	A local display is provided.	Select header contents on local display.	<ul style="list-style-type: none"> ■ Device tag ■ Free text 	-
Header text	The Free text option is selected in the Header parameter.	Enter display header text.	Max. 12 characters, such as letters, numbers or special characters (e.g. @, %, /)	-
Separator	A local display is provided.	Select decimal separator for displaying numerical values.	<ul style="list-style-type: none"> ■ . (point) ■ , (comma) 	. (point)
Backlight	One of the following conditions is met: <ul style="list-style-type: none"> ■ Order code for "Display; operation", option F "4-line, illum.; touch control" ■ Order code for "Display; operation", option G "4-line, illum.; touch control +WLAN" ■ Order code for "Display; operation", option O "Remote display 4-line illuminated; 10m/30ft cable; touch control" 	Switch the local display backlight on and off.	<ul style="list-style-type: none"> ■ Disable ■ Enable 	-

* Visibility depends on order options or device settings

10.6.6 WLAN configuration

The **WLAN Settings** submenu guides the user systematically through all the parameters that have to be set for the WLAN configuration.

Navigation

"Setup" menu → Advanced setup → WLAN settings

▶ WLAN settings	
WLAN	→ ⓘ 132
WLAN mode	→ ⓘ 132
SSID name	→ ⓘ 132
Network security	→ ⓘ 132
Security identification	→ ⓘ 132
User name	→ ⓘ 132

WLAN password	→ ⓘ 132
WLAN IP address	→ ⓘ 132
WLAN MAC address	
WLAN passphrase	→ ⓘ 132
WLAN MAC address	
Assign SSID name	→ ⓘ 133
SSID name	→ ⓘ 133
Connection state	→ ⓘ 133
Received signal strength	→ ⓘ 133



Parameter overview with brief description

Parameter	Prerequisite	Description	Selection / User entry / User interface	Factory setting
WLAN	-	Switch WLAN on and off.	<ul style="list-style-type: none"> ▪ Disable ▪ Enable 	-
WLAN mode	-	Select WLAN mode.	<ul style="list-style-type: none"> ▪ WLAN access point ▪ WLAN Client 	-
SSID name	The client is activated.	Enter the user-defined SSID name (max. 32 characters).	-	-
Network security	-	Select the security type of the WLAN network.	<ul style="list-style-type: none"> ▪ Unsecured ▪ WPA2-PSK ▪ EAP-PEAP with MSCHAPv2 * ▪ EAP-PEAP MSCHAPv2 no server authentic. * ▪ EAP-TLS * 	-
Security identification	-	Select security settings and download these settings via menu Data management > Security > WLAN.	<ul style="list-style-type: none"> ▪ Trusted issuer certificate ▪ Device certificate ▪ Device private key 	-
User name	-	Enter user name.	-	-
WLAN password	-	Enter WLAN password.	-	-
WLAN IP address	-	Enter IP address of the WLAN interface of the device.	4 octet: 0 to 255 (in the particular octet)	-
WLAN passphrase	The WPA2-PSK option is selected in the Security type parameter.	Enter the network key (8 to 32 characters).  The network key supplied with the device should be changed during commissioning for security reasons.	8 to 32-digit character string comprising numbers, letters and special characters (without spaces)	Serial number of the measuring device (e.g. L100A802000)

Parameter	Prerequisite	Description	Selection / User entry / User interface	Factory setting
Assign SSID name	–	Select which name will be used for SSID: device tag or user-defined name.	<ul style="list-style-type: none"> ▪ Device tag ▪ User-defined 	–
SSID name	<ul style="list-style-type: none"> ▪ The User-defined option is selected in the Assign SSID name parameter. ▪ The WLAN access point option is selected in the WLAN mode parameter. 	Enter the user-defined SSID name (max. 32 characters).  The user-defined SSID name may only be assigned once. If the SSID name is assigned more than once, the devices can interfere with one another.	Max. 32-digit character string comprising numbers, letters and special characters	EH_device designation_last 7 digits of the serial number (e.g. EH_Promass_300_A 802000)
Connection state	–	Displays the connection status.	<ul style="list-style-type: none"> ▪ Connected ▪ Not connected 	–
Received signal strength	–	Shows the received signal strength.	<ul style="list-style-type: none"> ▪ Low ▪ Medium ▪ High 	–

* Visibility depends on order options or device settings

10.6.7 Viscosity application package

 For detailed information on the parameter descriptions for the Viscosity application package, see the Special Documentation for the device →  259

Navigation

"Setup" menu → Advanced setup → Viscosity



10.6.8 Concentration Measurement application package

 For detailed information on the parameter descriptions for the Concentration application package, see the Special Documentation for the device →  259

Navigation

"Setup" menu → Advanced setup → Concentration



10.6.9 Petroleum application package

 For detailed information on the parameter descriptions for the Petroleum application package, see the Special Documentation for the device →  259

Navigation

"Setup" menu → Advanced setup → Petroleum

10.6.10 Heartbeat Technology application package

 For detailed information on the parameter descriptions of the application packages, see the Special Documentation for the device. →  259

Navigation

"Setup" menu → Advanced setup → Heartbeat setup

10.6.11 Configuration management

After commissioning, you can save the current device configuration or restore the previous device configuration. The device configuration is managed via the **Configuration management** parameter.

Navigation

"Setup" menu → Advanced setup → Configuration backup

► Configuration backup		
Operating time		→ ⓘ 134
Last backup		→ ⓘ 134
Configuration management		→ ⓘ 134
Backup state		→ ⓘ 134
Comparison result		→ ⓘ 134

Parameter overview with brief description

Parameter	Description	User interface / Selection
Operating time	Indicates how long the device has been in operation.	Days (d), hours (h), minutes (m) and seconds (s)
Last backup	Shows when the last data backup was saved to HistoROM backup.	Days (d), hours (h), minutes (m) and seconds (s)
Configuration management	Select action for managing the device data in the HistoROM backup.	<ul style="list-style-type: none"> ▪ Cancel ▪ Execute backup ▪ Restore * ▪ Compare * ▪ Clear backup data
Backup state	Shows the current status of data saving or restoring.	<ul style="list-style-type: none"> ▪ None ▪ Backup in progress ▪ Restoring in progress ▪ Delete in progress ▪ Compare in progress ▪ Restoring failed ▪ Backup failed
Comparison result	Comparison of current device data with HistoROM backup.	<ul style="list-style-type: none"> ▪ Settings identical ▪ Settings not identical ▪ No backup available ▪ Backup settings corrupt ▪ Check not done ▪ Dataset incompatible

* Visibility depends on order options or device settings

Function scope of the "Configuration management" parameter

Options	Description
Cancel	No action is executed and the user exits the parameter.
Execute backup	A backup copy of the current device configuration is saved from the HistoROM backup to the memory of the device. The backup copy includes the transmitter data of the device.
Restore	The last backup copy of the device configuration is restored from the device memory to the device's HistoROM backup. The backup copy includes the transmitter data of the device.
Compare	The device configuration saved in the device memory is compared with the current device configuration of the HistoROM backup.
Clear backup data	The backup copy of the device configuration is deleted from the memory of the device.

 **HistoROM backup**

A HistoROM is a "non-volatile" device memory in the form of an EEPROM.



While this action is in progress, the configuration cannot be edited via the local display and a message on the processing status appears on the display.



10.6.12 Using parameters for device administration

The **Administration** submenu systematically guides the user through all the parameters that can be used for device administration purposes.

Navigation

"Setup" menu → Advanced setup → Administration

▶ Administration



- ▶ Define access code →  135
- ▶ Reset access code →  136
- Device reset →  136

Using the parameter to define the access code

Navigation

"Setup" menu → Advanced setup → Administration → Define access code

▶ Define access code

- Define access code →  136
- Confirm access code →  136

Parameter overview with brief description

Parameter	Description	User entry
Define access code	Restrict write-access to parameters to protect the configuration of the device against unintentional changes.	Max. 16-digit character string comprising numbers, letters and special characters
Confirm access code	Confirm the entered access code.	Max. 16-digit character string comprising numbers, letters and special characters

Using the parameter to reset the access code

Navigation

"Setup" menu → Advanced setup → Administration → Reset access code

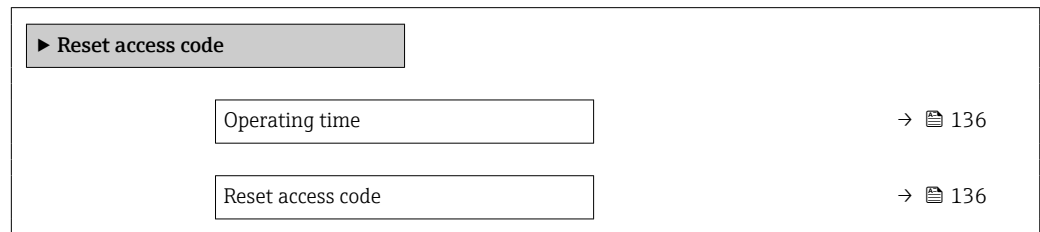

Parameter overview with brief description

Parameter	Description	User interface / User entry
Operating time	Indicates how long the device has been in operation.	Days (d), hours (h), minutes (m) and seconds (s)
Reset access code	<p>Reset access code to factory settings.</p> <p> For a reset code, contact your Endress+Hauser service organization.</p> <p>The reset code can only be entered via:</p> <ul style="list-style-type: none"> ▪ Web browser ▪ DeviceCare, FieldCare (via CDI-RJ45 service interface) ▪ Fieldbus 	Character string comprising numbers, letters and special characters

Using the parameter to reset the device

Navigation

"Setup" menu → Advanced setup → Administration

Parameter overview with brief description

Parameter	Description	Selection
Device reset	Reset the device configuration - either entirely or in part - to a defined state.	<ul style="list-style-type: none"> ▪ Cancel ▪ To delivery settings ▪ Restart device ▪ Restore S-DAT backup *

* Visibility depends on order options or device settings

10.7 Simulation

Via the **Simulation** submenu, it is possible to simulate various process variables in the process and the device alarm mode and verify downstream signal chains (switching valves

or closed-control loops). The simulation can be performed without a real measurement (no flow of medium through the device).

Navigation

"Diagnostics" menu → Simulation

► Simulation	
Assign simulation process variable	→ 138
Process variable value	→ 138
Status input simulation 1 to n	→ 139
Input signal level 1 to n	→ 139
Current input 1 to n simulation	→ 139
Value current input 1 to n	→ 139
Current output 1 to n simulation	→ 138
Value current output 1 to n	→ 138
Frequency output simulation 1 to n	→ 138
Frequency value 1 to n	→ 138
Pulse output simulation 1 to n	→ 138
Pulse value 1 to n	→ 138
Switch output simulation 1 to n	→ 138
Switch status 1 to n	→ 138
Relay output 1 to n simulation	→ 138
Switch status 1 to n	→ 138
Device alarm simulation	→ 138
Diagnostic event category	→ 138
Diagnostic event simulation	→ 138

Parameter overview with brief description



Parameter	Prerequisite	Description	Selection / User entry
Assign simulation process variable	–	Select a process variable for the simulation process that is activated.	<ul style="list-style-type: none"> ■ Off ■ Mass flow ■ Volume flow ■ Corrected volume flow * ■ Target mass flow * ■ Carrier mass flow * ■ Target volume flow * ■ Carrier volume flow * ■ Target corrected volume flow * ■ Carrier corrected volume flow * ■ Density ■ Reference density * ■ Temperature ■ Concentration *
Process variable value	A process variable is selected in the Assign simulation process variable parameter (→ 138).	Enter the simulation value for the selected process variable.	Depends on the process variable selected
Current output 1 to n simulation	–	Switch the simulation of the current output on and off.	<ul style="list-style-type: none"> ■ Off ■ On
Value current output 1 to n	In the Current output 1 to n simulation parameter, the On option is selected.	Enter the current value for simulation.	3.59 to 22.5 mA
Frequency output simulation 1 to n	In the Operating mode parameter, the Frequency option is selected.	Switch the simulation of the frequency output on and off.	<ul style="list-style-type: none"> ■ Off ■ On
Frequency value 1 to n	In the Frequency output simulation 1 to n parameter, the On option is selected.	Enter the frequency value for the simulation.	0.0 to 12 500.0 Hz
Pulse output simulation 1 to n	In the Operating mode parameter, the Pulse option is selected.	Set and switch off the pulse output simulation.  For Fixed value option: Pulse width parameter (→ 103) defines the pulse width of the pulses output.	<ul style="list-style-type: none"> ■ Off ■ Fixed value ■ Down-counting value
Pulse value 1 to n	In the Pulse output simulation 1 to n parameter, the Down-counting value option is selected.	Enter the number of pulses for simulation.	0 to 65 535
Switch output simulation 1 to n	In the Operating mode parameter, the Switch option is selected.	Switch the simulation of the switch output on and off.	<ul style="list-style-type: none"> ■ Off ■ On
Switch status 1 to n	–	Select the status of the status output for the simulation.	<ul style="list-style-type: none"> ■ Open ■ Closed
Relay output 1 to n simulation	–	Switch simulation of the relay output on and off.	<ul style="list-style-type: none"> ■ Off ■ On
Switch status 1 to n	The On option is selected in the Switch output simulation 1 to n parameter.	Select status of the relay output for the simulation.	<ul style="list-style-type: none"> ■ Open ■ Closed
Device alarm simulation	–	Switch the device alarm on and off.	<ul style="list-style-type: none"> ■ Off ■ On
Diagnostic event category	–	Select a diagnostic event category.	<ul style="list-style-type: none"> ■ Sensor ■ Electronics ■ Configuration ■ Process
Diagnostic event simulation	–	Select a diagnostic event to simulate this event.	<ul style="list-style-type: none"> ■ Off ■ Diagnostic event picklist (depends on the category selected)

Parameter	Prerequisite	Description	Selection / User entry
Current input 1 to n simulation	–	Switch simulation of the current input on and off.	<ul style="list-style-type: none"> ■ Off ■ On
Value current input 1 to n	In the Current input 1 to n simulation parameter, the On option is selected.	Enter the current value for simulation.	0 to 22.5 mA
Status input simulation 1 to n	–	Switch simulation of the status input on and off.	<ul style="list-style-type: none"> ■ Off ■ On
Input signal level 1 to n	In the Status input simulation parameter, the On option is selected.	Select the signal level for the simulation of the status input.	<ul style="list-style-type: none"> ■ High ■ Low

* Visibility depends on order options or device settings

10.8 Protecting settings from unauthorized access

The following write protection options exist in order to protect the configuration of the measuring device from unintentional modification:



- Protect access to parameters via access code →  139
- Protect access to local operation via key locking →  63
- Protect access to measuring device via write protection switch →  140
- Protect access to parameters via startup configuration

10.8.1 Write protection via access code





The effects of the user-specific access code are as follows:

- Via local operation, the parameters for the measuring device configuration are write-protected and their values can no longer be changed.
- Device access is protected via the Web browser, as are the parameters for the measuring device configuration.
- Device access is protected via FieldCare or DeviceCare (via CDI-RJ45 service interface), as are the parameters for the measuring device configuration.

Defining the access code via the local display

1. Navigate to the **Define access code** parameter (→  136).
2. Maximum of 16-digit character string comprising numbers, letters and special characters as the access code.
3. Enter the access code again in the **Confirm access code** parameter (→  136) to confirm.

↳ The  symbol appears in front of all write-protected parameters.

- 
 - Disabling parameter write protection via access code →  62.
 - If the access code is lost: Resetting the access code →  140.
 - The user role with which the user is currently logged in is displayed in **Access status** parameter.
 - Navigation path: Operation → Access status
 - User roles and their access rights →  62
- The device automatically locks the write-protected parameters again if a key is not pressed for 10 minutes in the navigation and editing view.
- The device locks the write-protected parameters automatically after 60 s if the user skips back to the operational display mode from the navigation and editing view.

Parameters which can always be modified via the local display

Certain parameters that do not affect the measurement are excepted from parameter write protection via the local display. Despite the user-specific access code, they can always be modified, even if the other parameters are locked.

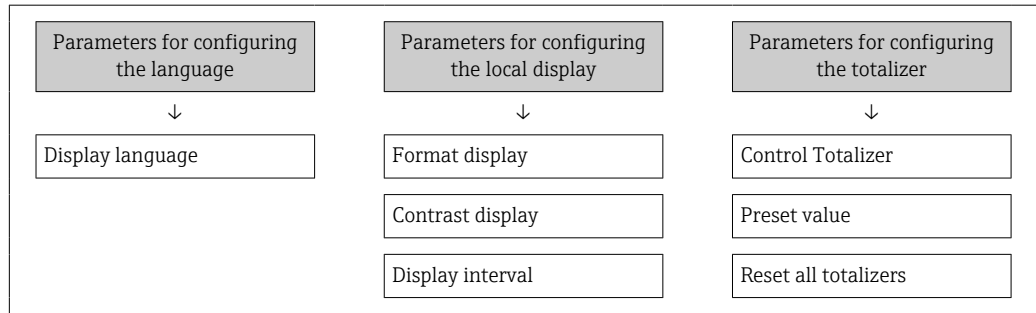

Defining the access code via the web browser

1. Navigate to the **Define access code** parameter (→ 📄 136).
2. Define a 16-digit (max.) numeric code as the access code.
3. Enter the access code again in the **Confirm access code** parameter (→ 📄 136) to confirm.
 - ↳ The web browser switches to the login page.

- i** Disabling parameter write protection via access code → 📄 62.
- If the access code is lost: Resetting the access code → 📄 140.
- The **Access status** parameter shows which user role the user is currently logged in with.
 - Navigation path: Operation → Access status
 - User roles and their access rights → 📄 62

If no action is performed for 10 minutes, the web browser automatically returns to the login page.

Resetting the access code

If you misplace the user-specific access code, it is possible to reset the code to the factory setting. A reset code must be entered for this purpose. The user-specific access code can then be defined again afterwards.

Via Web browser, FieldCare, DeviceCare (via CDI-RJ45 service interface), fieldbus

- i** You can only obtain a reset code from your local Endress+Hauser service organization. The code must be calculated explicitly for every device.

1. Note down the serial number of the device.
2. Read off the **Operating time** parameter.
3. Contact the local Endress+Hauser service organization and tell them the serial number and the operating time.
 - ↳ Get the calculated reset code.
4. Enter the reset code in the **Reset access code** parameter (→ 📄 136).
 - ↳ The access code has been reset to the factory setting **0000**. It can be redefined → 📄 139.

- i** For IT security reasons, the calculated reset code is only valid for 96 hours from the specified operating time and for the specific serial number. If you cannot return to the device within 96 hours, you should either increase the operating time you read out by a few days or switch off the device.

10.8.2 Write protection via write protection switch

Unlike parameter write protection via a user-specific access code, this allows the user to lock write access to the entire operating menu - apart from the **"Contrast display" parameter**.

The parameter values are now read only and cannot be edited any more (exception "**Contrast display**" parameter):

- Via local display
- Via PROFINET protocol

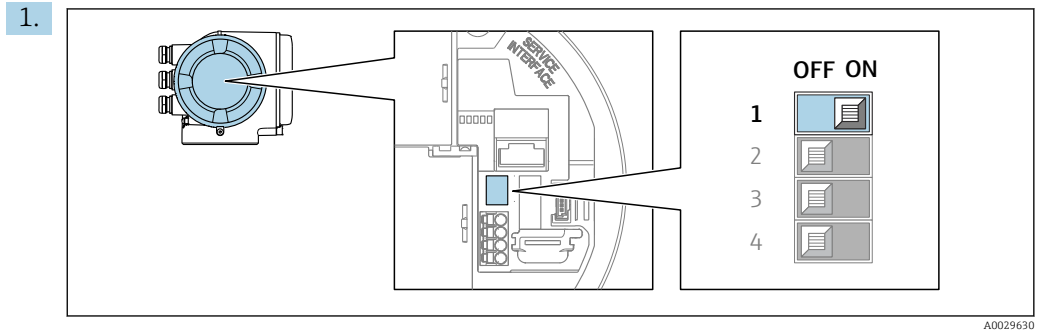

A0029630

Setting the write protection (WP) switch on the main electronics module to the **ON** position enables hardware write protection.

- ↳ In the **Locking status** parameter, the **Hardware locked** option is displayed → 142. In addition, on the local display the  symbol appears in front of the parameters in the header of the operational display and in the navigation view.

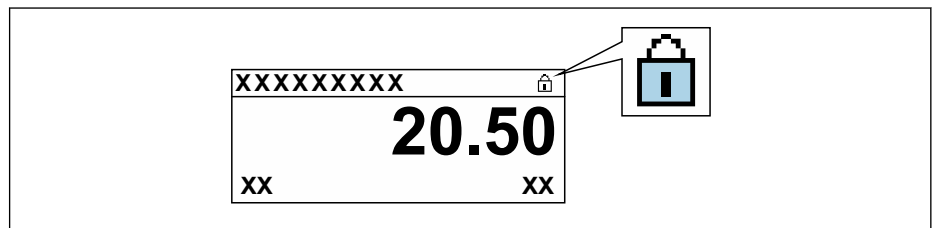

A0029425

2. Setting the write protection (WP) switch on the main electronics module to the **OFF** position (factory setting) disables hardware write protection.

- ↳ No option is displayed in the **Locking status** parameter → 142. On the local display, the  symbol disappears from in front of the parameters in the header of the operational display and in the navigation view.



11 Operation

11.1 Reading off the device locking status

Device active write protection: **Locking status** parameter



Operation → Locking status

Function scope of the "Locking status" parameter

Options	Description
None	The access authorization displayed in the Access status parameter applies →  62. Only appears on local display.
Hardware locked	The DIP switch for hardware locking is activated on the PCB board. This locks write access to the parameters (e.g. via local display or operating tool) →  140.
Temporarily locked	Write access to the parameters is temporarily locked on account of internal processes running in the device (e.g. data upload/download, reset, etc.). Once the internal processing has been completed, the parameters can be changed once again.



11.2 Adjusting the operating language

 Detailed information:

- To configure the operating language →  87
- For information on the operating languages supported by the measuring device →  250

11.3 Configuring the display

Detailed information:





- On the basic settings for the local display →  112
- On the advanced settings for the local display →  128

11.4 Reading measured values

With the **Measured values** submenu, it is possible to read all the measured values.

Navigation

"Diagnostics" menu → Measured values

▶ Measured values	
▶ Measured variables	→  143
▶ Input values	→  146
▶ Output values	→  147
▶ Totalizer	→  145

11.4.1 "Measured variables" submenu

The **Measured variables** submenu contains all the parameters needed to display the current measured values for each process variable.





Navigation



"Diagnostics" menu → Measured values → Measured variables

► Measured variables	
Mass flow	→ ⓘ 143
Volume flow	→ ⓘ 143
Corrected volume flow	→ ⓘ 144
Density	→ ⓘ 144
Reference density	→ ⓘ 144
Temperature	→ ⓘ 144
Pressure	→ ⓘ 144
Concentration	→ ⓘ 144
Target mass flow	→ ⓘ 144
Carrier mass flow	→ ⓘ 144
Target corrected volume flow	→ ⓘ 144
Carrier corrected volume flow	→ ⓘ 145
Target volume flow	→ ⓘ 145
Carrier volume flow	→ ⓘ 145

Parameter overview with brief description

Parameter	Prerequisite	Description	User interface
Mass flow	–	Displays the mass flow that is currently measured. <i>Dependency</i> The unit is taken from: Mass flow unit parameter (→ ⓘ 91)	Signed floating-point number
Volume flow	–	Displays the volume flow that is currently calculated. <i>Dependency</i> The unit is taken from the Volume flow unit parameter (→ ⓘ 91).	Signed floating-point number

Parameter	Prerequisite	Description	User interface
Corrected volume flow	–	Displays the corrected volume flow that is currently calculated. <i>Dependency</i> The unit is taken from: Corrected volume flow unit parameter (→ ⓘ 91)	Signed floating-point number
Density	–	Shows the density currently measured. <i>Dependency</i> The unit is taken from the Density unit parameter (→ ⓘ 91).	Signed floating-point number
Reference density	–	Displays the reference density that is currently calculated. <i>Dependency</i> The unit is taken from: Reference density unit parameter (→ ⓘ 91)	Signed floating-point number
Temperature	–	Shows the medium temperature currently measured. <i>Dependency</i> The unit is taken from: Temperature unit parameter (→ ⓘ 92)	Signed floating-point number
Pressure value	–	Displays either a fixed or external pressure value. <i>Dependency</i> The unit is taken from the Pressure unit parameter (→ ⓘ 92).	Signed floating-point number
Concentration	For the following order code: Order code for "Application package", option ED "Concentration"  The software options currently enabled are displayed in the Software option overview parameter.	Displays the concentration that is currently calculated. <i>Dependency</i> The unit is taken from the Concentration unit parameter.	Signed floating-point number
Target mass flow	With the following conditions: Order code for "Application package", option ED "Concentration"  The software options currently enabled are displayed in the Software option overview parameter.	Displays the mass flow that is currently measured for the target medium. <i>Dependency</i> The unit is taken from: Mass flow unit parameter (→ ⓘ 91)	Signed floating-point number
Carrier mass flow	With the following conditions: Order code for "Application package", option ED "Concentration"  The software options currently enabled are displayed in the Software option overview parameter.	Displays the mass flow of the carrier medium that is currently measured. <i>Dependency</i> The unit is taken from: Mass flow unit parameter (→ ⓘ 91)	Signed floating-point number
Target corrected volume flow	With the following conditions: <ul style="list-style-type: none"> ▪ Order code for "Application package", option ED "Concentration" ▪ The Ethanol in water option or %mass / %volume option is selected in the Liquid type parameter.  The software options currently enabled are displayed in the Software option overview parameter.	Displays the corrected volume flow that is currently measured for the target fluid. <i>Dependency</i> The unit is taken from the Volume flow unit parameter (→ ⓘ 91).	Signed floating-point number

Parameter	Prerequisite	Description	User interface
Carrier corrected volume flow	With the following conditions: <ul style="list-style-type: none"> Order code for "Application package", option ED "Concentration" In the Liquid type parameter, the Ethanol in water option or %mass / %volume option is selected.  The software options currently enabled are displayed in the Software option overview parameter.	Displays the corrected volume flow currently measured for the carrier fluid. <i>Dependency</i> The unit is taken from the Volume flow unit parameter (→ 91).	Signed floating-point number
Target volume flow	With the following conditions: <ul style="list-style-type: none"> Order code for "Application package", option ED "Concentration" The Ethanol in water option or %mass / %volume option is selected in the Liquid type parameter. The %vol option is selected in the Concentration unit parameter.  The software options currently enabled are displayed in the Software option overview parameter.	Displays the volume flow currently measured for the target medium. <i>Dependency</i> The unit is taken from the Volume flow unit parameter (→ 91).	Signed floating-point number
Carrier volume flow	With the following conditions: <ul style="list-style-type: none"> Order code for "Application package", option ED "Concentration" The Ethanol in water option or %mass / %volume option is selected in the Liquid type parameter. The %vol option is selected in the Concentration unit parameter.  The software options currently enabled are displayed in the Software option overview parameter.	Displays the volume flow currently measured for the carrier medium. <i>Dependency</i> The unit is taken from the Volume flow unit parameter (→ 91).	Signed floating-point number

11.4.2 Totalizer

The **Totalizer** submenu contains all the parameters needed to display the current measured values for every totalizer.

Navigation

"Diagnostics" menu → Measured values → Totalizer

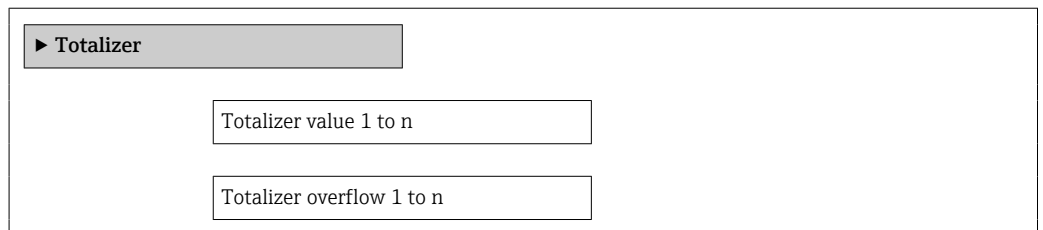

Parameter overview with brief description

Parameter	Prerequisite	Description	Selection / User entry / User interface
Assign process variable	-	Select process variable for totalizer.	<ul style="list-style-type: none"> ■ Volume flow ■ Mass flow ■ Corrected volume flow
Totalizer value 1 to n	One of the following options is selected in the Assign process variable parameter: <ul style="list-style-type: none"> ■ Volume flow ■ Mass flow ■ Corrected volume flow ■ Total mass flow ■ Condensate mass flow ■ Energy flow ■ Heat flow difference 	Displays the current totalizer counter value.	Signed floating-point number
Totalizer status 1 to n	-	Displays the current totalizer status.	<ul style="list-style-type: none"> ■ Good ■ Uncertain ■ Bad
Totalizer status (Hex) 1 to n	In Target mode parameter, the Auto option is selected.	Displays the current status value (hex) of the totalizer.	0 to 0xFF

11.4.3 "Input values" submenu

The **Input values** submenu guides you systematically to the individual input values.

Navigation

"Diagnostics" menu → Measured values → Input values

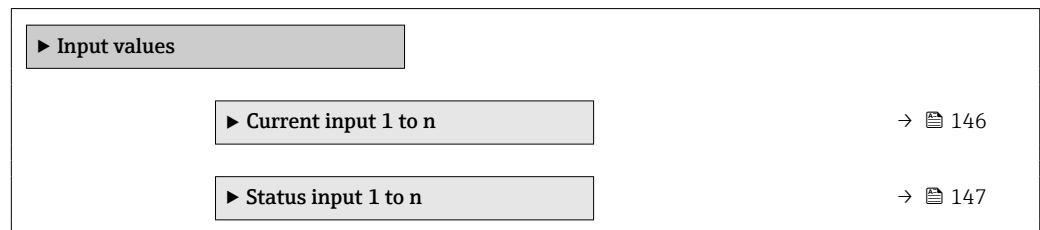

Input values of current input

The **Current input 1 to n** submenu contains all the parameters needed to display the current measured values for every current input.

Navigation

"Diagnostics" menu → Measured values → Input values → Current input 1 to n

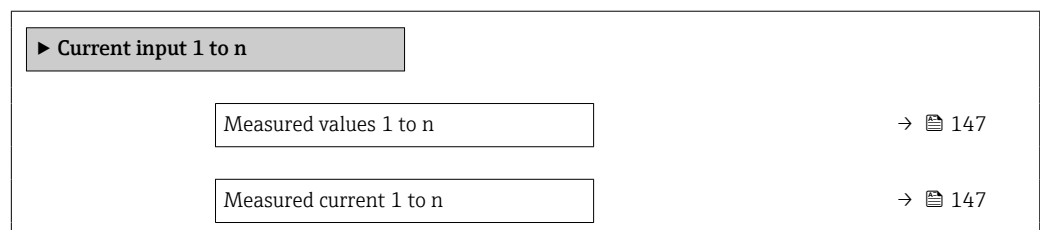

Parameter overview with brief description

Parameter	Description	User interface
Measured values 1 to n	Displays the current input value.	Signed floating-point number
Measured current 1 to n	Displays the current value of the current input.	0 to 22.5 mA

Input values of status input

The **Status input 1 to n** submenu contains all the parameters needed to display the current measured values for every status input.

Navigation

"Diagnostics" menu → Measured values → Input values → Status input 1 to n

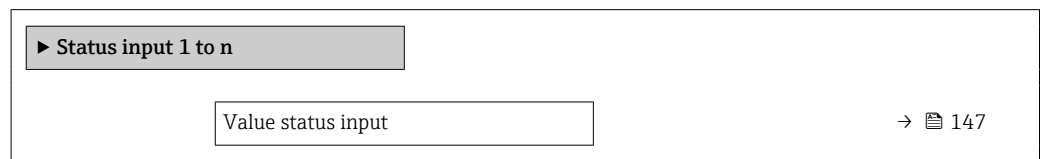

Parameter overview with brief description

Parameter	Description	User interface
Value status input	Shows the current input signal level.	<ul style="list-style-type: none"> ■ High ■ Low

11.4.4 Output values

The **Output values** submenu contains all the parameters needed to display the current measured values for every output.

Navigation

"Diagnostics" menu → Measured values → Output values

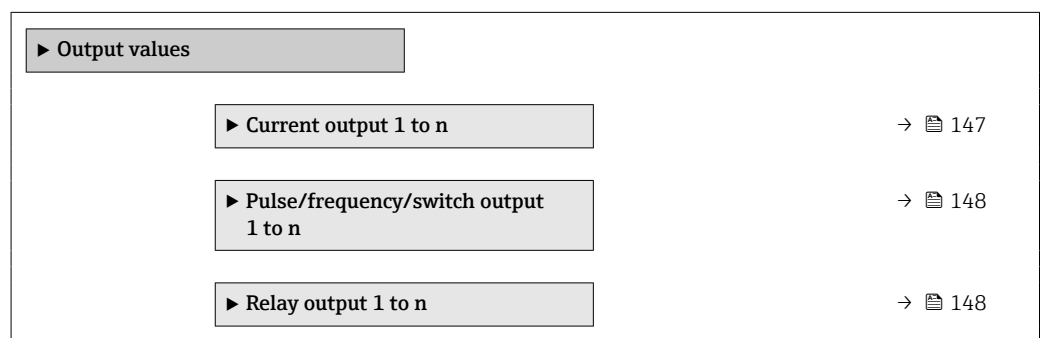

Output values of current output

The **Value current output** submenu contains all the parameters needed to display the current measured values for every current output.

Navigation

"Diagnostics" menu → Measured values → Output values → Value current output 1 to n

▶ **Current output 1 to n**

Output current 1 to n

→ 148

Measured current 1 to n

→ 148

Parameter overview with brief description

Parameter	Description	User interface
Output current 1	Displays the current value currently calculated for the current output.	3.59 to 22.5 mA
Measured current	Displays the current value currently measured for the current output.	0 to 30 mA

Output values for pulse/frequency/switch output

The **Pulse/frequency/switch output 1 to n** submenu contains all the parameters needed to display the current measured values for every pulse/frequency/switch output.

Navigation

"Diagnostics" menu → Measured values → Output values → Pulse/frequency/switch output 1 to n

▶ **Pulse/frequency/switch output 1 to n**

Output frequency 1 to n

→ 148

Pulse output 1 to n

→ 148

Switch status 1 to n

→ 148

Parameter overview with brief description

Parameter	Prerequisite	Description	User interface
Output frequency 1 to n	In the Operating mode parameter, the Frequency option is selected.	Displays the value currently measured for the frequency output.	0.0 to 12 500.0 Hz
Pulse output 1 to n	The Pulse option is selected in the Operating mode parameter parameter.	Displays the pulse frequency currently output.	Positive floating-point number
Switch status 1 to n	The Switch option is selected in the Operating mode parameter.	Displays the current switch output status.	<ul style="list-style-type: none"> ■ Open ■ Closed

Output values for relay output

The **Relay output 1 to n** submenu contains all the parameters needed to display the current measured values for every relay output.

Navigation

"Diagnostics" menu → Measured values → Output values → Relay output 1 to n

▶ **Relay output 1 to n**

Switch status	→ ⓘ 149
Switch cycles	→ ⓘ 149
Max. switch cycles number	→ ⓘ 149

Parameter overview with brief description

Parameter	Description	User interface
Switch status	Shows the current relay switch status.	<ul style="list-style-type: none"> ▪ Open ▪ Closed
Switch cycles	Shows number of all performed switch cycles.	Positive integer
Max. switch cycles number	Shows the maximal number of guaranteed switch cycles.	Positive integer

11.5 Adapting the measuring device to the process conditions

The following are available for this purpose:

- Basic settings using the **Setup** menu (→ ⓘ 88)
- Advanced settings using the **Advanced setup** submenu (→ ⓘ 117)

11.6 Performing a totalizer reset

The totalizers are reset in the **Operation** submenu:

- Control Totalizer
- Reset all totalizers

Navigation

"Operation" menu → Totalizer handling

▶ **Totalizer handling**

Control Totalizer 1 to n (0912-1 to n)	
Preset value 1 to n (0913-1 to n)	
Reset all totalizers (2806)	→ ⓘ 150

Parameter overview with brief description

Parameter	Description	Selection / User entry
Totalizer 1 to n control	Operate the totalizer.	<ul style="list-style-type: none"> ■ Reset + hold ■ Preset + hold ■ Hold ■ Totalize
Preset value 1 to n	Specify start value for totalizer.	Signed floating-point number
Reset all totalizers	Reset all totalizers to 0 and start.	<ul style="list-style-type: none"> ■ Cancel ■ Reset + totalize

11.6.1 Function scope of "Control Totalizer" parameter

Options	Description
Totalize	The totalizer is started or continues running.
Reset + hold	The totaling process is stopped and the totalizer is reset to 0.
Preset + hold ¹⁾	The totaling process is stopped and the totalizer is set to its defined start value from the Preset value parameter.
Reset + totalize	The totalizer is reset to 0 and the totaling process is restarted.
Preset + totalize ¹⁾	The totalizer is set to the defined start value in the Preset value parameter and the totaling process is restarted.
Hold	Totalizing is stopped.



1) Visible depending on the order options or device settings

11.6.2 Function range of "Reset all totalizers" parameter

Options	Description
Cancel	No action is executed and the user exits the parameter.
Reset + totalize	Resets all totalizers to 0 and restarts the totaling process. This deletes all the previously aggregated flow values.

11.7 Displaying the measured value history

The **Extended HistoROM** application package must be enabled in the device (order option) for the **Data logging** submenu to appear. This contains all the parameters for the measured value history.

-  Data logging is also available via:
- Plant Asset Management Tool FieldCare →  73.
 - Web browser

Function range

- A total of 1000 measured values can be stored
- 4 logging channels
- Adjustable logging interval for data logging
- Measured value trend for each logging channel displayed in the form of a chart

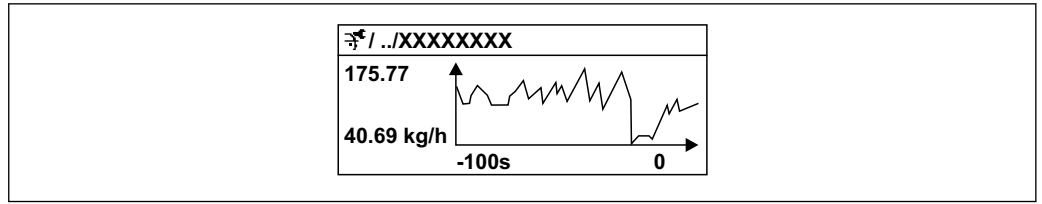

30 Chart of a measured value trend

- x-axis: depending on the number of channels selected displays 250 to 1000 measured values of a process variable.
- y-axis: displays the approximate measured value span and constantly adapts this to the ongoing measurement.

i If the length of the logging interval or the assignment of the process variables to the channels is changed, the content of the data logging is deleted.





Navigation



"Diagnostics" menu → Data logging

▶ Data logging

Assign channel 1	→ 152
Assign channel 2	→ 152
Assign channel 3	→ 152
Assign channel 4	→ 153
Logging interval	→ 153
Clear logging data	→ 153
Data logging	→ 153
Logging delay	→ 153
Data logging control	→ 153
Data logging status	→ 153
Entire logging duration	→ 153
▶ Display channel 1	
▶ Display channel 2	
▶ Display channel 3	
▶ Display channel 4	

Parameter overview with brief description

Parameter	Prerequisite	Description	Selection / User entry / User interface
Assign channel 1	The Extended HistoROM application package is available.	Assign process variable to logging channel.	<ul style="list-style-type: none"> ■ Off ■ Mass flow ■ Volume flow ■ Corrected volume flow * ■ Density ■ Reference density * ■ Temperature ■ Oscillation amplitude * ■ Current output 1 * ■ Current output 2 * ■ Current output 3 * ■ Current output 4 * ■ Pressure ■ Concentration * ■ Target mass flow * ■ Carrier mass flow * ■ Target volume flow * ■ Carrier volume flow * ■ Target corrected volume flow * ■ Carrier corrected volume flow * ■ Oscillation amplitude * ■ Current output 1 * ■ Current output 2 * ■ Current output 3 * ■ Current output 4 * ■ Index inhomogeneous medium ■ Application specific output 0 * ■ Application specific output 1 * ■ HBSI * ■ Exciter current 0 ■ Oscillation damping 0 ■ Oscillation damping fluctuation 0 * ■ Oscillation frequency 0 ■ Oscillation amplitude * ■ Frequency fluctuation 0 * ■ Oscillation amplitude 1 * ■ Signal asymmetry ■ Carrier pipe temperature * ■ Electronic temperature ■ Index suspended bubbles *
Assign channel 2	The Extended HistoROM application package is available.  The software options currently enabled are displayed in the Software option overview parameter.	Assign a process variable to logging channel.	For the picklist, see Assign channel 1 parameter (→  152)
Assign channel 3	The Extended HistoROM application package is available.  The software options currently enabled are displayed in the Software option overview parameter.	Assign a process variable to logging channel.	For the picklist, see Assign channel 1 parameter (→  152)

Parameter	Prerequisite	Description	Selection / User entry / User interface
Assign channel 4	The Extended HistoROM application package is available.  The software options currently enabled are displayed in the Software option overview parameter.	Assign a process variable to logging channel.	For the picklist, see Assign channel 1 parameter (->  152)
Logging interval	The Extended HistoROM application package is available.	Define the logging interval for data logging. This value defines the time interval between the individual data points in the memory.	0.1 to 3 600.0 s
Clear logging data	The Extended HistoROM application package is available.	Clear the entire logging data.	<ul style="list-style-type: none"> ■ Cancel ■ Clear data
Data logging	–	Select the type of data logging.	<ul style="list-style-type: none"> ■ Overwriting ■ Not overwriting
Logging delay	In the Data logging parameter, the Not overwriting option is selected.	Enter the time delay for measured value logging.	0 to 999 h
Data logging control	In the Data logging parameter, the Not overwriting option is selected.	Start and stop measured value logging.	<ul style="list-style-type: none"> ■ None ■ Delete + start ■ Stop
Data logging status	In the Data logging parameter, the Not overwriting option is selected.	Displays the measured value logging status.	<ul style="list-style-type: none"> ■ Done ■ Delay active ■ Active ■ Stopped
Entire logging duration	In the Data logging parameter, the Not overwriting option is selected.	Displays the total logging duration.	Positive floating-point number

* Visibility depends on order options or device settings

11.8 Gas Fraction Handler

The Gas Fraction Handler improves measurement stability and repeatability in the event of two-phase media and provides valuable diagnostic information for the process.



The function continuously checks for the presence of gas bubbles in liquids or droplets in gases, as this second phase influences the output values for flow and density.

In the case of two-phase media, the Gas Fraction Handler stabilizes the output values and enables better readability for operators and easier interpretation by the distributed control system. The level of smoothing is adjusted according to the severity of the disturbances introduced by the second phase. In the case of single-phase media, the Gas Fraction Handler does not have any influence on the output values.

Possible options in the Gas Fraction Handler parameter:

- **Off**: Disables the Gas Fraction Handler. When a second phase is present, large fluctuations in the values output for flow and density will occur.
- **Moderate**: Use for applications with low levels or intermittent levels of second phase.
- **Powerful**: Use for applications with very significant levels of second phase.

The Gas Fraction Handler is cumulative to any fixed damping constants applied to flow and density that are set elsewhere in the instrument parameterization.

 For detailed information on the parameter descriptions of the Gas Fraction Handler, see the Special Documentation for the device ->  259

11.8.1 "Measurement mode" submenu

Navigation

"Expert" menu → Sensor → Measurement mode

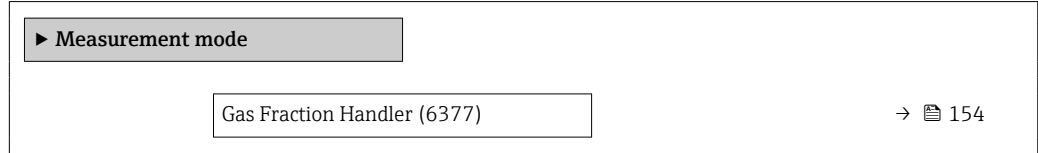

Parameter overview with brief description

Parameter	Description	Selection
Gas Fraction Handler	Activates the Gas Fraction Handler function for two phase media.	<ul style="list-style-type: none"> ▪ Off ▪ Moderate ▪ Powerful

11.8.2 "Medium index" submenu

Navigation

"Expert" menu → Application → Medium index

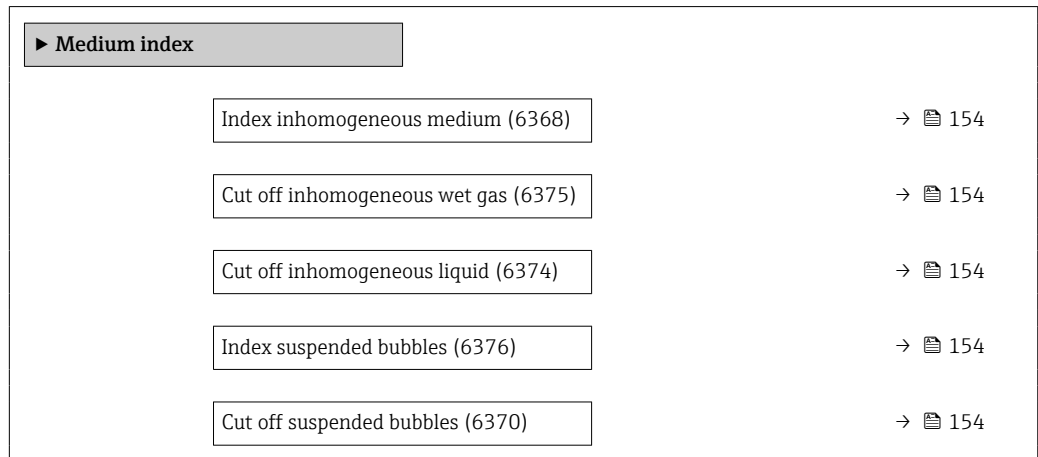

Parameter overview with brief description

Parameter	Prerequisite	Description	User interface / User entry
Index inhomogeneous medium	-	Shows the degree of inhomogeneity of the medium.	Signed floating-point number
Cut off inhomogeneous wet gas	-	Enter cut off value for wet gas applications. Below this value the Index inhomogeneous medium is set to 0.	Positive floating-point number
Cut off inhomogeneous liquid	-	Enter cut off value for liquid applications. Below this value the 'Inhomogeneous medium index' is set to 0.	Positive floating-point number
Index suspended bubbles	The diagnostic index is only available for Promass Q.	Shows the relative amount of suspended bubbles in the medium.	Signed floating-point number
Cut off suspended bubbles	The parameter is only available for Promass Q.	Enter the cut off value for suspended bubbles. Below this value the 'Index for suspended bubbles' is set to 0.	Positive floating-point number

12 Diagnostics and troubleshooting

12.1 General troubleshooting

For local display

Error	Possible causes	Remedial action
Local display is dark, but signal output is within the valid range	The cable of the display module is not plugged in correctly.	Insert the plug correctly into the main electronics module and display module.
Local display dark and no output signals	Supply voltage does not match the voltage specified on the nameplate.	Apply the correct supply voltage .
Local display dark and no output signals	Supply voltage has incorrect polarity.	Reverse polarity of supply voltage.
Local display dark and no output signals	No contact between connecting cables and terminals.	Ensure electrical contact between the cable and the terminal.
Local display dark and no output signals	<ul style="list-style-type: none"> ▪ Terminals are not plugged into the I/O electronics module correctly. ▪ Terminals are not plugged into the main electronics module correctly. 	Check terminals.
Local display dark and no output signals	<ul style="list-style-type: none"> ▪ I/O electronics module is defective. ▪ Main electronics module is defective. 	Order spare part → ☰ 225.
Local display cannot be read, but signal output is within the valid range	Display is set too bright or too dark.	<ul style="list-style-type: none"> ▪ Set the display brighter by simultaneously pressing ☐ + ☐. ▪ Set the display darker by simultaneously pressing ☐ + ☐.
Local display is dark, but signal output is within the valid range	Display module is defective.	Order spare part → ☰ 225.
Backlighting of local display is red	Diagnostic event with "Alarm" diagnostic behavior has occurred.	Take remedial measures → ☰ 167
Text on local display appears in a language that cannot be understood.	The selected operating language cannot be understood.	<ol style="list-style-type: none"> 1. Press ☐ + ☐ for 2 s ("home position"). 2. Press ☐. 3. Configure the required language in the Display language parameter (→ ☰ 130).
Message on local display: "Communication Error" "Check Electronics"	Communication between the display module and the electronics is interrupted.	<ul style="list-style-type: none"> ▪ Check the cable and the connector between the main electronics module and display module. ▪ Order spare part → ☰ 225.

For output signals

Error	Possible causes	Remedial action
Signal output outside the valid range	Main electronics module is defective.	Order spare part → ☰ 225.
Device shows correct value on local display, but signal output is incorrect, though in the valid range.	Parameter configuration error	Check and adjust parameter configuration.
Device measures incorrectly.	Configuration error or device is operated outside the application.	<ol style="list-style-type: none"> 1. Check and correct parameter configuration. 2. Observe limit values specified in the "Technical Data".

For access

Fault	Possible causes	Remedial action
Write access to parameters is not possible.	Hardware write protection is enabled.	Set the write protection switch on the main electronics module to the OFF position → ☰ 140.
Write access to parameters is not possible.	Current user role has limited access authorization.	1. Check user role → ☰ 62. 2. Enter correct customer-specific access code → ☰ 62.
Connection via PROFINET is not possible.	PROFINET bus cable is incorrectly connected.	Check the terminal assignment → ☰ 35.
Connection via PROFINET is not possible.	Device plug is incorrectly connected.	Check the pin assignment of the device plugs .
Unable to connect to the web server.	Web server is disabled.	Using the "FieldCare" or "DeviceCare" operating tool, check whether the web server of the device is enabled, and enable it if necessary → ☰ 69.
	The Ethernet interface on the PC is incorrectly configured.	<ul style="list-style-type: none"> ▶ Check the properties of the Internet protocol (TCP/IP)→ ☰ 65. ▶ Check the network settings with the IT manager.
Unable to connect to the web server.	<ul style="list-style-type: none"> ▪ The IP address on the PC is incorrectly configured. ▪ IP address is not known. 	<ul style="list-style-type: none"> ▶ If addressing via hardware: open the transmitter and check the IP address configured (last octet). ▶ Check the IP address of the device with the IT manager. ▶ If the IP address is not known, set DIP switch no.10 on the I/O electronics module 10 to ON, restart the device and enter the factory IP address 192.168.1.212.
	The web browser setting "Use a proxy server for your LAN" is enabled on the PC.	Disable use of the proxy server in the LAN settings. Using the example of MS Internet Explorer: <ul style="list-style-type: none"> ▶ Under <i>Control Panel</i>, open <i>Internet options</i>. ▶ Select the <i>Connections</i> tab. ▶ Double-click <i>LAN Settings</i>. ▶ In <i>LAN Settings</i>, disable use of the proxy server. ▶ Press <i>OK</i> to confirm.
	Apart from the active network connection to the measuring instrument, other network connections are also being used.	<ul style="list-style-type: none"> ▪ Make sure that there are no other network connections from the PC (including WLAN) and close other programs on the PC with network access. ▪ If using a docking station for notebooks, make sure that a network connection to another network is not active.
Unable to connect to the web server.	WLAN access data are incorrect.	<ul style="list-style-type: none"> ▪ Check WLAN network status. ▪ Log on to the device again using WLAN access data. ▪ Check that WLAN is enabled on the measuring instrument and operating unit → ☰ 65.
	WLAN communication is disabled.	–
Unable to connect to web server, FieldCare or DeviceCare.	WLAN network is not available.	<ul style="list-style-type: none"> ▪ Check if WLAN reception is present: LED on display module is lit blue. ▪ Check if WLAN connection is enabled: LED on display module flashes blue. ▪ Switch on instrument function.
Network connection not present or unstable	WLAN network is weak.	<ul style="list-style-type: none"> ▪ Operating unit outside reception range: Check network status on operating unit. ▪ To improve network performance, use an external WLAN antenna.
	Parallel WLAN and Ethernet communication	<ul style="list-style-type: none"> ▪ Check network settings. ▪ Temporarily enable only the WLAN as an interface.

Fault	Possible causes	Remedial action
Web browser frozen and operation no longer possible	Data transfer is active.	Wait until data transfer or current action is finished.
	Connection lost	<ul style="list-style-type: none"> ▶ Check cable connection and power supply. ▶ Refresh the web browser and restart if necessary.
Display of web browser content is difficult to read or incomplete.	Web browser version used is not optimal.	<ul style="list-style-type: none"> ▶ Use correct web browser version → 64. ▶ Empty the web browser cache. ▶ Restart the web browser.
	Unsuitable view settings.	Change the font size/display ratio of the Web browser.
Incomplete or no display of content in the web browser	<ul style="list-style-type: none"> ▪ JavaScript is not enabled. ▪ JavaScript cannot be enabled. 	<ul style="list-style-type: none"> ▶ Enable JavaScript. ▶ Enter http://XXX.XXX.X.XX/servlet/basic.html as the IP address.
Operation with FieldCare or DeviceCare via service interface CDI-RJ45 (port 8000) is not possible.	Firewall of the PC or network is blocking communication.	Depending on the settings of the firewall used on the PC or in the network, the firewall must be adapted or disabled to allow FieldCare/ DeviceCare access.
Flashing the firmware with FieldCare or DeviceCare via service interface CDI-RJ45 (port 8000 or TFTP ports) is not possible.	Firewall of the PC or network is blocking communication.	Depending on the settings of the firewall used on the PC or in the network, the firewall must be adapted or disabled to allow FieldCare/ DeviceCare access.

For system integration

Error	Possible causes	Remedy
The PROFINET device name is not displayed correctly and contains coding.	A device name containing one or more underscores has been specified via the automation system.	Specify a correct device name (without underscores) via the automation system.

12.2 Diagnostic information via light emitting diodes

12.2.1 Transmitter

Different LEDs in the transmitter provide information on the device status.

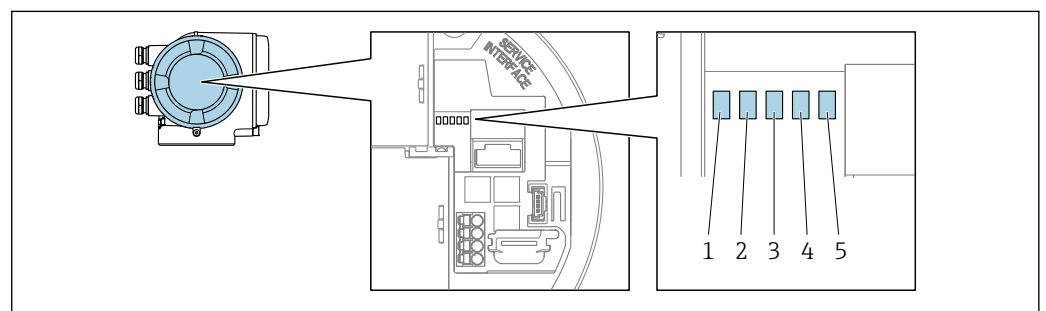

A0029629

- 1 Supply voltage
- 2 Device status
- 3 Flashing/network status
- 4 Port 1 active: PROFINET
- 5 Port 2 active: PROFINET and service interface (CDI)

LED	Color	Meaning
1 Supply voltage	Off	Supply voltage is off or too low.
	Green	Supply voltage is OK.
2 Device status (normal operation)	Off	Firmware error.
	Green	Device status is OK.
	Flashing green	Device is not configured.
	Flashing red	A diagnostic event with "Warning" diagnostic behavior has occurred.
	Red	A diagnostic event with "Alarm" diagnostic behavior has occurred.
2 Device status (during start-up)	Flashes red slowly	If > 30 seconds: problem with the boot loader.
	Flashes red quickly	If > 30 seconds: compatibility problem when reading the firmware.
3 Flashing/network status	Green	Cyclic data exchange is active.
	Flashing green	Following request from automation system: Flash frequency: 1 Hz (flash functionality: 500 ms on, 500 ms off) Cyclic data exchange is not active, no IP address is available: Flash frequency: 3 Hz
	Red	IP address is available but there is no connection to the automation system
	Flashing red	Cyclic data exchange was active but the connection was disconnected: Flash frequency: 3 Hz
4 Port 1 active: PROFINET	Off	Not connected or no connection established.
	White	Connected and connection established.
	Flashing white	Communication not active.
5 Port 2 active: PROFINET and service interface (CDI)	Off	Not connected or no connection established.
	Yellow	Connected and connection established.
	Flashing yellow	Communication not active.

12.3 Diagnostic information on local display

12.3.1 Diagnostic message

Faults detected by the self-monitoring system of the measuring device are displayed as a diagnostic message in alternation with the operational display.

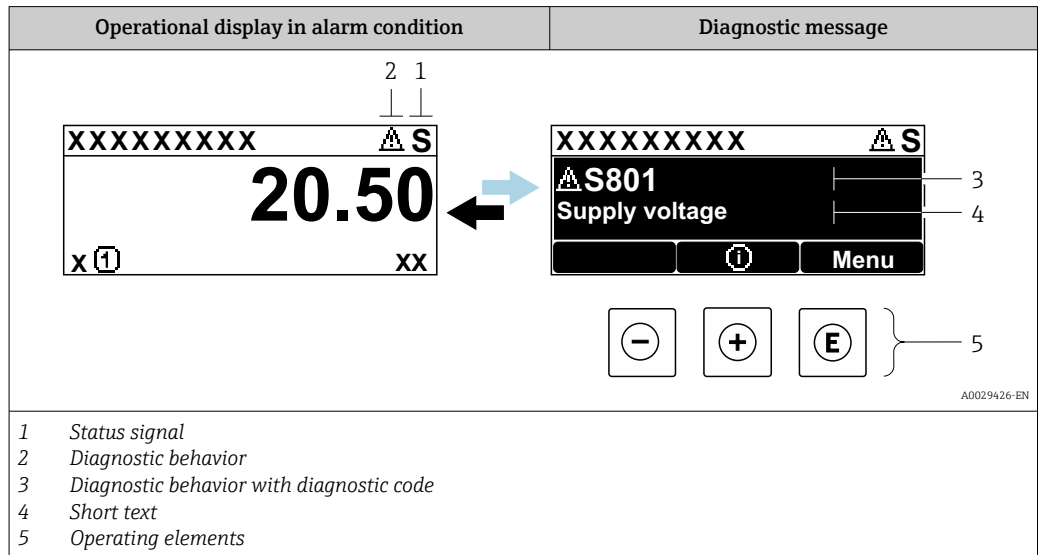

If two or more diagnostic events are pending simultaneously, only the message of the diagnostic event with the highest priority is shown.

- i** Other diagnostic events that have occurred can be displayed in the **Diagnostics** menu:
 - Via parameter → 218
 - Via submenus → 218



Status signals

The status signals provide information on the state and reliability of the device by categorizing the cause of the diagnostic information (diagnostic event).

- i** The status signals are categorized according to VDI/VDE 2650 and NAMUR Recommendation NE 107: F = Failure, C = Function Check, S = Out of Specification, M = Maintenance Required

Symbol	Meaning
F	Failure A device error has occurred. The measured value is no longer valid.
C	Function check The device is in service mode (e.g. during a simulation).
S	Out of specification The device is being operated: Outside its technical specification limits (e.g. outside the process temperature range)
M	Maintenance required Maintenance is required. The measured value remains valid.



Diagnostic behavior

Symbol	Meaning
	Alarm <ul style="list-style-type: none"> ▪ Measurement is interrupted. ▪ Signal outputs and totalizers assume the defined alarm condition. ▪ A diagnostic message is generated.
	Warning <ul style="list-style-type: none"> ▪ Measurement is resumed. ▪ The signal outputs and totalizers are not affected. ▪ A diagnostic message is generated.

Diagnostic information

The fault can be identified using the diagnostic information. The short text helps you by providing information about the fault. In addition, the corresponding symbol for the diagnostic behavior is displayed in front of the diagnostic information on the local display.

Operating elements

Operating key	Meaning
	Plus key <i>In menu, submenu</i> Opens the message about the remedial measures.
	Enter key <i>In menu, submenu</i> Opens the operating menu.

12.3.2 Calling up remedial measures

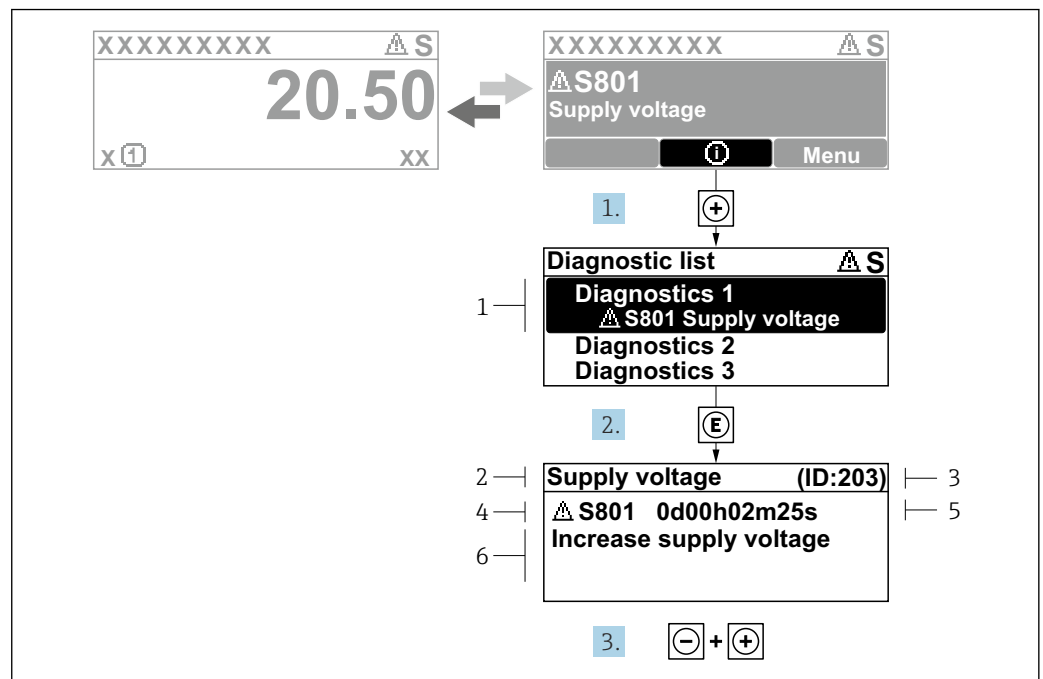

31 Message for remedial measures

- 1 Diagnostic information
- 2 Short text
- 3 Service ID
- 4 Diagnostic behavior with diagnostic code
- 5 Operation time when error occurred
- 6 Remedial measures

1. The user is in the diagnostic message.
Press \oplus ($\textcircled{1}$ symbol).
↳ The **Diagnostic list** submenu opens.
2. Select the desired diagnostic event with \oplus or \ominus and press E .
↳ The message about the remedial measures opens.
3. Press $\ominus + \oplus$ simultaneously.
↳ The message about the remedial measures closes.

The user is in the **Diagnostics** menu at an entry for a diagnostics event, e.g. in the **Diagnostic list** submenu or **Previous diagnostics** parameter.

1. Press E .
↳ The message for the remedial measures for the selected diagnostic event opens.
2. Press $\ominus + \oplus$ simultaneously.
↳ The message for the remedial measures closes.



12.4 Diagnostic information in the web browser

12.4.1 Diagnostic options

Any faults detected by the measuring device are displayed in the Web browser on the home page once the user has logged on.





- 1 Status area with status signal
- 2 Diagnostic information
- 3 Remedial measures with service ID

 In addition, diagnostic events which have occurred can be shown in the **Diagnostics** menu:

- Via parameter →  218
- Via submenu →  218

Status signals

The status signals provide information on the state and reliability of the device by categorizing the cause of the diagnostic information (diagnostic event).

Symbol	Meaning
	Failure A device error has occurred. The measured value is no longer valid.
	Function check The device is in service mode (e.g. during a simulation).
	Out of specification The device is being operated: Outside its technical specification limits (e.g. outside the process temperature range)
	Maintenance required Maintenance is required. The measured value remains valid.

 The status signals are categorized in accordance with VDI/VDE 2650 and NAMUR Recommendation NE 107.

12.4.2 Calling up remedy information

Remedy information is provided for every diagnostic event to ensure that problems can be rectified quickly. These measures are displayed in red along with the diagnostic event and the related diagnostic information.

12.5 Diagnostic information in FieldCare or DeviceCare

12.5.1 Diagnostic options

Any faults detected by the measuring device are displayed on the home page of the operating tool once the connection has been established.

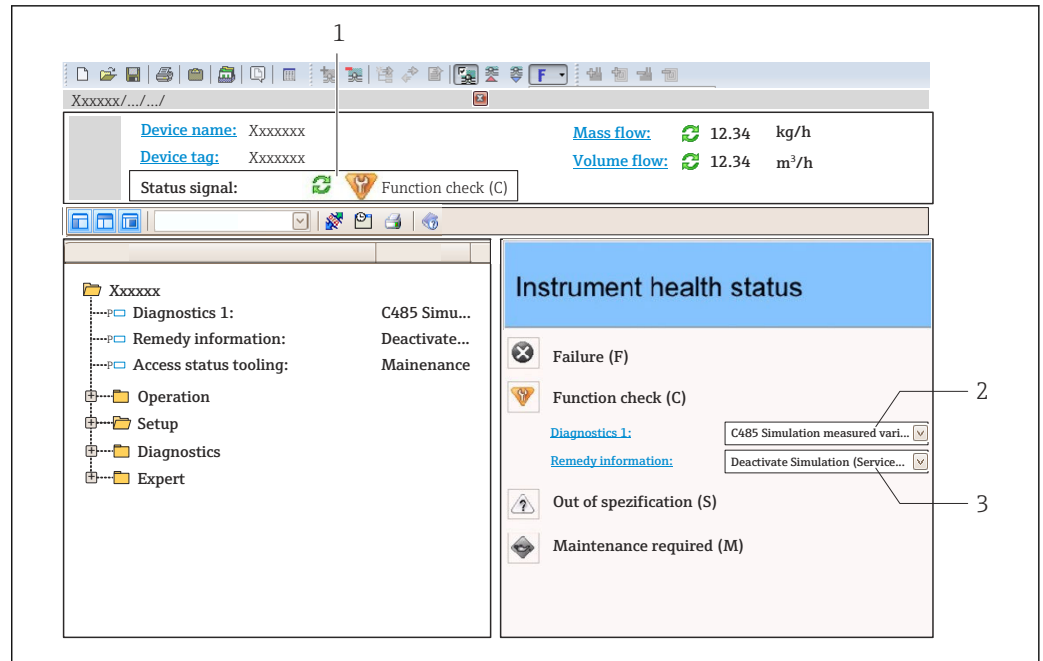

- 1 Status area with status signal → 159
 2 Diagnostic information → 160
 3 Remedial measures with service ID

i In addition, diagnostic events which have occurred can be shown in the **Diagnostics** menu:

- Via parameter → 218
- Via submenu → 218

Diagnostic information

The fault can be identified using the diagnostic information. The short text helps you by providing information about the fault. In addition, the corresponding symbol for the diagnostic behavior is displayed in front of the diagnostic information on the local display.

12.5.2 Calling up remedy information

Remedy information is provided for every diagnostic event to ensure that problems can be rectified quickly:

- On the home page
Remedy information is displayed in a separate field below the diagnostics information.
- In the **Diagnostics** menu
Remedy information can be called up in the working area of the user interface.

The user is in the **Diagnostics** menu.

1. Call up the desired parameter.
2. On the right in the working area, mouse over the parameter.
 - ↳ A tool tip with remedy information for the diagnostic event appears.

12.6 Adapting the diagnostic information

12.6.1 Adapting the diagnostic behavior

Each item of diagnostic information is assigned a specific diagnostic behavior at the factory. The user can change this assignment for specific diagnostic information in the **Diagnostic behavior** submenu.

Expert → System → Diagnostic handling → Diagnostic behavior

Available diagnostic behaviors

The following diagnostic behaviors can be assigned:

Diagnostic behavior	Description
Alarm	The device stops measurement. The totalizers assume the defined alarm condition. A diagnostic message is generated.
Warning	The device continues to measure. Measured value output via PROFINET and totalizers are not affected. A diagnostic message is generated.
Logbook entry only	The device continues to measure. The diagnostic message is only displayed in the Event logbook submenu (Event list submenu) and is not displayed in alternating sequence with the operational display.
Off	The diagnostic event is ignored, and no diagnostic message is generated or entered.

Displaying the measured value status

If modules with input data (e.g. Analog Input module, Discrete Input module, Totalizer module, Heartbeat module) are configured for cyclic data transmission, the measured value status is coded as per PROFINET PA Profile 4 Specification and transmitted along with the measured value to the PROFINET Controller via the status byte. The status byte is split into three segments: Quality, Quality Substatus and Limits.

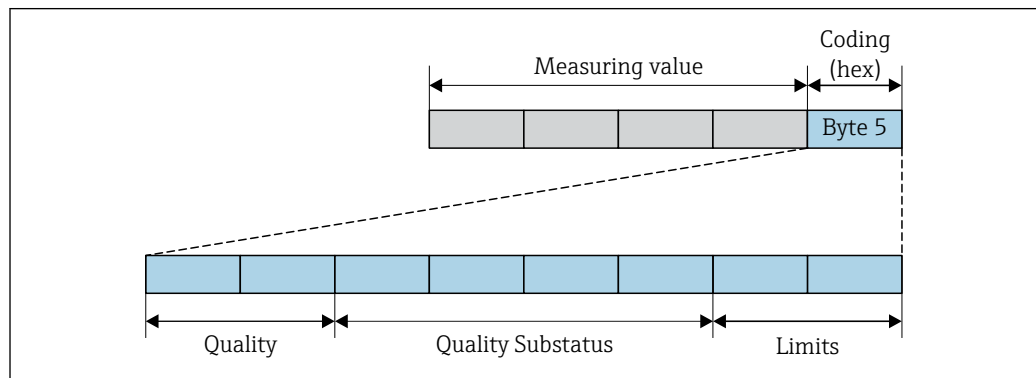

32 Structure of the status byte

A0032228-EN

The content of the status byte depends on the configured failure mode in the individual function block. Depending on which failure mode has been configured, status information in accordance with PROFINET PA Profile Specification 4 is transmitted to the the PROFINET controller via the status byte status information. The two bits for the limits always have the value 0.

Supported status information

Status	Coding (hex)
BAD - Maintenance alarm	0x24
BAD - Process related	0x28
BAD - Function check	0x3C
UNCERTAIN - Initial value	0x4F
UNCERTAIN - Maintenance demanded	0x68
UNCERTAIN - Process related	0x78
GOOD - OK	0x80
GOOD - Maintenance demanded	0xA8
GOOD - Function check	0xBC

Determining the measured value status and device status via the diagnostic behavior

When the diagnostic behavior is assigned, this also changes the measured value status and device status for the diagnostic information. The measured value status and device status depend on the choice of diagnostic behavior and on the group in which the diagnostic information is located.

The diagnostic information is grouped as follows:

- Diagnostic information pertaining to the sensor: diagnostic number 000 to 199
→ 165
- Diagnostic information pertaining to the electronics: diagnostic number 200 to 399
→ 165
- Diagnostic information pertaining to the configuration: diagnostic number 400 to 599
→ 166
- Diagnostic information pertaining to the process: diagnostic number 800 to 999
→ 166

Depending on the group in which the diagnostic information is located, the following measured value status and device status are firmly assigned to the particular diagnostic behavior:

Diagnostic information pertaining to the sensor: diagnostic number 000 to 199

Diagnostic behavior (configurable)	Measured value status (fixed assignment)				Device diagnosis (fixed assignment)
	Quality	Quality Substatus	Coding (hex)	Category (NE107)	
Alarm	BAD	Maintenance alarm	0x24	F (Failure)	Maintenance alarm
Warning	GOOD	Maintenance demanded	0xA8	M (Maintenance)	Maintenance demanded
Logbook entry only	GOOD	ok	0x80	-	-
Off					

Diagnostic information pertaining to the electronics: diagnostic number 200 to 399

Diagnostic number 200 to 301, 303 to 399

Diagnostic behavior (configurable)	Measured value status (fixed assignment)				Device diagnostics (fixed assignment)
	Quality	Quality Substatus	Coding (hex)	Category (NE107)	
Alarm	BAD	Maintenance alarm	0x24	F (Failure)	Maintenance alarm
Warning					

Diagnostic behavior (configurable)	Measured value status (fixed assignment)				Device diagnostics (fixed assignment)
	Quality	Quality Substatus	Coding (hex)	Category (NE107)	
Logbook entry only	GOOD	ok	0x80 to 0x8E	-	-
Off					

Diagnostic information 302

Diagnostic behavior (configurable)	Measured value status (fixed assignment)				Device diagnostics (fixed assignment)
	Quality	Quality Substatus	Coding (hex)	Category (NE107)	
Alarm	BAD	Function check, local override	0x24	C	Function check
Warning	GOOD	Function check	0xBC to 0xBF	-	-

Diagnostic information 302 (device verification active) is output during internal or external Heartbeat verification.

- Signal status: Function check
- Choice of diagnostic behavior: alarm or warning (factory setting)

When the Heartbeat Verification is started, data logging is interrupted, the last valid measured value is output and the totalizer counter is stopped.



Diagnostic information pertaining to the configuration: diagnostic number 400 to 599

Diagnostic behavior (configurable)	Measured value status (fixed assignment)				Device diagnosis (fixed assignment)
	Quality	Quality Substatus	Coding (hex)	Category (NE107)	
Alarm	BAD	Process related	0x28	F (Failure)	Invalid process condition
Warning	UNCERTAIN	Process related	0x78	S (Out of specification)	Invalid process condition
Logbook entry only	GOOD	ok	0x80	-	-
Off					

Diagnostic information pertaining to the process: diagnostic number 800 to 999

Diagnostic behavior (configurable)	Measured value status (fixed assignment)				Device diagnosis (fixed assignment)
	Quality	Quality Substatus	Coding (hex)	Category (NE107)	
Alarm	BAD	Process related	0x28	F (Failure)	Invalid process condition
Warning	UNCERTAIN	Process related	0x78	S (Out of specification)	Invalid process condition
Logbook entry only	GOOD	ok	0x80	-	-
Off					

12.7 Overview of diagnostic information

-  The amount of diagnostic information and the number of measured variables affected increase if the measuring device has one or more application packages.
 - All of the measured variables affected in the entire Promass instrument family are always listed under "Measured variables affected". The measured variables available for the device in question depend on the device version. When assigning the measured variables to the device functions, for example to the individual outputs, all of the measured variables available for the device version in question are available for selection.
-  In the case of some items of diagnostic information, the diagnostic behavior can be changed. Adapting the diagnostic information →  164

12.7.1 Diagnostic of sensor

Diagnostic information		Remedy instructions	
No.	Short text		
022	Temperature sensor defective	1. Check or replace sensor electronic module (ISEM) 2. If available: Check connection cable between sensor and transmitter 3. Replace sensor	
	Measured variable status		
	Quality		Bad
	Quality substatus		Maintenance alarm
	Coding (hex)		0x24 to 0x27
	Status signal		F
	Diagnostic behavior		Alarm
	Influenced measured variables		
<ul style="list-style-type: none"> ▪ Oscillation amplitude 1 ▪ Oscillation amplitude 2 ▪ Application specific output ▪ Application specific output ▪ Signal asymmetry ▪ Carrier mass flow ▪ Carrier pipe temperature ▪ Target corrected volume flow ▪ Carrier corrected volume flow ▪ Concentration ▪ Oscillation damping 1 ▪ Oscillation damping 2 ▪ Density ▪ Oil density ▪ Water density ▪ Dynamic viscosity ▪ Sensor electronic temperature (ISEM) ▪ GSV flow ▪ GSV flow alternative ▪ Kinematic viscosity ▪ Mass flow ▪ Oil mass flow ▪ Water mass flow ▪ Index inhomogeneous medium ▪ Index suspended bubbles ▪ HBSI ▪ NSV flow ▪ NSV flow alternative ▪ External pressure ▪ Exciter current 1 ▪ Exciter current 2 ▪ Oscillation frequency 1 ▪ Oscillation frequency 2 ▪ S&W volume flow ▪ Reference density ▪ Reference density alternative ▪ Corrected volume flow ▪ Oil corrected volume flow ▪ Water corrected volume flow ▪ Oscillation damping fluctuation 1 ▪ Oscillation damping fluctuation 2 ▪ Frequency fluctuation 1 ▪ Frequency fluctuation 2 ▪ Target mass flow ▪ Carrier volume flow ▪ Target volume flow ▪ Temp. compensated dynamic viscosity ▪ Temp. compensated kinematic viscosity ▪ Temperature ▪ Status ▪ Volume flow ▪ Oil volume flow ▪ Water volume flow ▪ Water cut 			

Diagnostic information		Remedy instructions	
No.	Short text		
046	Sensor limit exceeded	1. Inspect sensor 2. Check process condition	
	Measured variable status [from the factory] ¹⁾		
	Quality		Good
	Quality substatus		Ok
	Coding (hex)		0x80 to 0x83
	Status signal		S
	Diagnostic behavior		Warning
Influenced measured variables			
<ul style="list-style-type: none"> ▪ Oscillation amplitude 1 ▪ Oscillation amplitude 2 ▪ Application specific output ▪ Application specific output ▪ Signal asymmetry ▪ Carrier mass flow ▪ Carrier pipe temperature ▪ Target corrected volume flow ▪ Carrier corrected volume flow ▪ Concentration ▪ Oscillation damping 1 ▪ Oscillation damping 2 ▪ Density ▪ Oil density ▪ Water density ▪ Dynamic viscosity ▪ Sensor electronic temperature (ISEM) ▪ GSV flow ▪ GSV flow alternative ▪ Kinematic viscosity ▪ Mass flow ▪ Oil mass flow ▪ Water mass flow ▪ Index inhomogeneous medium ▪ Index suspended bubbles ▪ HBSI ▪ NSV flow ▪ NSV flow alternative ▪ External pressure ▪ Exciter current 1 ▪ Exciter current 2 ▪ Oscillation frequency 1 ▪ Oscillation frequency 2 ▪ S&W volume flow ▪ Reference density ▪ Reference density alternative ▪ Corrected volume flow ▪ Oil corrected volume flow ▪ Water corrected volume flow ▪ Oscillation damping fluctuation 1 ▪ Oscillation damping fluctuation 2 ▪ Frequency fluctuation 1 ▪ Frequency fluctuation 2 ▪ Target mass flow ▪ Carrier volume flow ▪ Target volume flow ▪ Temp. compensated dynamic viscosity ▪ Temp. compensated kinematic viscosity ▪ Temperature ▪ Status ▪ Volume flow ▪ Oil volume flow ▪ Water volume flow ▪ Water cut 			

1) Diagnostic behavior can be changed. This causes the overall status of the measured variable to change.

Diagnostic information		Remedy instructions	
No.	Short text		
062	Sensor connection faulty	1. Check or replace sensor electronic module (ISEM) 2. If available: Check connection cable between sensor and transmitter 3. Replace sensor	
	Measured variable status		
	Quality		Bad
	Quality substatus		Maintenance alarm
	Coding (hex)		0x24 to 0x27
	Status signal		F
	Diagnostic behavior		Alarm
Influenced measured variables			
<ul style="list-style-type: none"> ▪ Oscillation amplitude 1 ▪ Oscillation amplitude 2 ▪ Application specific output ▪ Application specific output ▪ Signal asymmetry ▪ Carrier mass flow ▪ Carrier pipe temperature ▪ Target corrected volume flow ▪ Carrier corrected volume flow ▪ Concentration ▪ Oscillation damping 1 ▪ Oscillation damping 2 ▪ Density ▪ Oil density ▪ Water density ▪ Dynamic viscosity ▪ Sensor electronic temperature (ISEM) ▪ GSV flow 		<ul style="list-style-type: none"> ▪ GSV flow alternative ▪ Kinematic viscosity ▪ Mass flow ▪ Oil mass flow ▪ Water mass flow ▪ Index inhomogeneous medium ▪ Index suspended bubbles ▪ HBSI ▪ NSV flow ▪ NSV flow alternative ▪ External pressure ▪ Exciter current 1 ▪ Exciter current 2 ▪ Oscillation frequency 1 ▪ Oscillation frequency 2 ▪ S&W volume flow ▪ Reference density ▪ Reference density alternative 	
		<ul style="list-style-type: none"> ▪ Corrected volume flow ▪ Oil corrected volume flow ▪ Water corrected volume flow ▪ Oscillation damping fluctuation 1 ▪ Oscillation damping fluctuation 2 ▪ Frequency fluctuation 1 ▪ Frequency fluctuation 2 ▪ Target mass flow ▪ Carrier volume flow ▪ Target volume flow ▪ Temp. compensated dynamic viscosity ▪ Temp. compensated kinematic viscosity ▪ Temperature ▪ Status ▪ Volume flow ▪ Oil volume flow ▪ Water volume flow ▪ Water cut 	

Diagnostic information		Remedy instructions	
No.	Short text		
063	Exciter current faulty	1. Check or replace sensor electronic module (ISEM) 2. If available: Check connection cable between sensor and transmitter 3. Replace sensor	
	Measured variable status		
	Quality		Bad
	Quality substatus		Maintenance alarm
	Coding (hex)		0x24 to 0x27
	Status signal		S
	Diagnostic behavior		Alarm
Influenced measured variables			
<ul style="list-style-type: none"> ▪ Oscillation amplitude 1 ▪ Oscillation amplitude 2 ▪ Application specific output ▪ Application specific output ▪ Signal asymmetry ▪ Carrier mass flow ▪ Carrier pipe temperature ▪ Target corrected volume flow ▪ Carrier corrected volume flow ▪ Concentration ▪ Oscillation damping 1 ▪ Oscillation damping 2 ▪ Density ▪ Oil density ▪ Water density ▪ Dynamic viscosity ▪ Sensor electronic temperature (ISEM) 		<ul style="list-style-type: none"> ▪ GSV flow ▪ GSV flow alternative ▪ Kinematic viscosity ▪ Mass flow ▪ Oil mass flow ▪ Water mass flow ▪ Index inhomogeneous medium ▪ Index suspended bubbles ▪ HBSI ▪ NSV flow ▪ NSV flow alternative ▪ External pressure ▪ Exciter current 1 ▪ Exciter current 2 ▪ Oscillation frequency 1 ▪ Oscillation frequency 2 ▪ S&W volume flow 	
		<ul style="list-style-type: none"> ▪ Reference density ▪ Reference density alternative ▪ Corrected volume flow ▪ Oil corrected volume flow ▪ Water corrected volume flow ▪ Target mass flow ▪ Carrier volume flow ▪ Target volume flow ▪ Temp. compensated dynamic viscosity ▪ Temp. compensated kinematic viscosity ▪ Temperature ▪ Status ▪ Volume flow ▪ Oil volume flow ▪ Water volume flow ▪ Water cut 	

Diagnostic information		Remedy instructions	
No.	Short text		
082	Data storage	1. Check module connections 2. Contact service	
Measured variable status			
Quality	Bad		
Quality substatus	Maintenance alarm		
Coding (hex)	0x24 to 0x27		
Status signal	F		
Diagnostic behavior	Alarm		
Influenced measured variables			
<ul style="list-style-type: none"> ▪ Oscillation amplitude 1 ▪ Oscillation amplitude 2 ▪ Application specific output ▪ Application specific output ▪ Signal asymmetry ▪ Carrier mass flow ▪ Carrier pipe temperature ▪ Target corrected volume flow ▪ Carrier corrected volume flow ▪ Concentration ▪ Measured values 1 ▪ Measured values 2 ▪ Measured values 3 ▪ Oscillation damping 1 ▪ Oscillation damping 2 ▪ Density ▪ Oil density ▪ Water density ▪ Dynamic viscosity 		<ul style="list-style-type: none"> ▪ Sensor electronic temperature (ISEM) ▪ GSV flow ▪ GSV flow alternative ▪ Kinematic viscosity ▪ Mass flow ▪ Oil mass flow ▪ Water mass flow ▪ Index inhomogeneous medium ▪ Index suspended bubbles ▪ HBSI ▪ NSV flow ▪ NSV flow alternative ▪ External pressure ▪ Exciter current 1 ▪ Exciter current 2 ▪ Oscillation frequency 1 ▪ Oscillation frequency 2 ▪ S&W volume flow ▪ Reference density 	<ul style="list-style-type: none"> ▪ Reference density alternative ▪ Corrected volume flow ▪ Oil corrected volume flow ▪ Water corrected volume flow ▪ Oscillation damping fluctuation 1 ▪ Oscillation damping fluctuation 2 ▪ Frequency fluctuation 1 ▪ Frequency fluctuation 2 ▪ Target mass flow ▪ Carrier volume flow ▪ Target volume flow ▪ Temp. compensated dynamic viscosity ▪ Temp. compensated kinematic viscosity ▪ Temperature ▪ Status ▪ Volume flow ▪ Oil volume flow ▪ Water volume flow ▪ Water cut

Diagnostic information		Remedy instructions	
No.	Short text		
083	Memory content	1. Restart device 2. Restore HistoROM S-DAT backup ('Device reset' parameter) 3. Replace HistoROM S-DAT	
	Measured variable status		
	Quality		Bad
	Quality substatus		Maintenance alarm
	Coding (hex)		0x24 to 0x27
	Status signal		F
	Diagnostic behavior		Alarm
Influenced measured variables			
<ul style="list-style-type: none"> ▪ Oscillation amplitude 1 ▪ Oscillation amplitude 2 ▪ Application specific output ▪ Application specific output ▪ Signal asymmetry ▪ Carrier mass flow ▪ Carrier pipe temperature ▪ Target corrected volume flow ▪ Carrier corrected volume flow ▪ Concentration ▪ Measured values 1 ▪ Measured values 2 ▪ Measured values 3 ▪ Oscillation damping 1 ▪ Oscillation damping 2 ▪ Density ▪ Oil density ▪ Water density ▪ Dynamic viscosity ▪ Sensor electronic temperature (ISEM) ▪ GSV flow ▪ GSV flow alternative ▪ Kinematic viscosity ▪ Mass flow ▪ Oil mass flow ▪ Water mass flow ▪ Index inhomogeneous medium ▪ Index suspended bubbles ▪ HBSI ▪ NSV flow ▪ NSV flow alternative ▪ External pressure ▪ Exciter current 1 ▪ Exciter current 2 ▪ Oscillation frequency 1 ▪ Oscillation frequency 2 ▪ S&W volume flow ▪ Reference density ▪ Reference density alternative ▪ Corrected volume flow ▪ Oil corrected volume flow ▪ Water corrected volume flow ▪ Oscillation damping fluctuation 1 ▪ Oscillation damping fluctuation 2 ▪ Frequency fluctuation 1 ▪ Frequency fluctuation 2 ▪ Target mass flow ▪ Carrier volume flow ▪ Target volume flow ▪ Temp. compensated dynamic viscosity ▪ Temp. compensated kinematic viscosity ▪ Temperature ▪ Status ▪ Volume flow ▪ Oil volume flow ▪ Water volume flow ▪ Water cut 			

Diagnostic information		Remedy instructions	
No.	Short text		
140	Sensor signal asymmetrical	1. Check or replace sensor electronic module (ISEM) 2. If available: Check connection cable between sensor and transmitter 3. Replace sensor	
	Measured variable status [from the factory] ¹⁾		
	Quality		Good
	Quality substatus		Ok
	Coding (hex)		0x80 to 0x83
	Status signal		S
	Diagnostic behavior		Alarm
Influenced measured variables			
<ul style="list-style-type: none"> ▪ Oscillation amplitude 1 ▪ Oscillation amplitude 2 ▪ Application specific output ▪ Application specific output ▪ Signal asymmetry ▪ Carrier mass flow ▪ Carrier pipe temperature ▪ Target corrected volume flow ▪ Carrier corrected volume flow ▪ Concentration ▪ Measured values 1 ▪ Measured values 2 ▪ Measured values 3 ▪ Oscillation damping 1 ▪ Oscillation damping 2 ▪ Density ▪ Oil density ▪ Water density ▪ Dynamic viscosity ▪ Sensor electronic temperature (ISEM) ▪ GSV flow ▪ GSV flow alternative ▪ Kinematic viscosity ▪ Mass flow ▪ Oil mass flow ▪ Water mass flow ▪ Index inhomogeneous medium ▪ Index suspended bubbles ▪ HBSI ▪ NSV flow ▪ NSV flow alternative ▪ External pressure ▪ Exciter current 1 ▪ Exciter current 2 ▪ Oscillation frequency 1 ▪ Oscillation frequency 2 ▪ S&W volume flow ▪ Reference density ▪ Reference density alternative ▪ Corrected volume flow ▪ Oil corrected volume flow ▪ Water corrected volume flow ▪ Oscillation damping fluctuation 1 ▪ Oscillation damping fluctuation 2 ▪ Frequency fluctuation 1 ▪ Frequency fluctuation 2 ▪ Target mass flow ▪ Carrier volume flow ▪ Target volume flow ▪ Temp. compensated dynamic viscosity ▪ Temp. compensated kinematic viscosity ▪ Temperature ▪ Status ▪ Volume flow ▪ Oil volume flow ▪ Water volume flow ▪ Water cut 			

1) Diagnostic behavior can be changed. This causes the overall status of the measured variable to change.

Diagnostic information		Remedy instructions	
No.	Short text		
144	Measurement error too high	1. Check or change sensor 2. Check process conditions	
	Measured variable status [from the factory] ¹⁾		
	Quality		Good
	Quality substatus		Ok
	Coding (hex)		0x80 to 0x83
	Status signal		F
	Diagnostic behavior		Alarm
Influenced measured variables			
<ul style="list-style-type: none"> ▪ Oscillation amplitude 1 ▪ Oscillation amplitude 2 ▪ Application specific output ▪ Application specific output ▪ Signal asymmetry ▪ Carrier mass flow ▪ Carrier pipe temperature ▪ Target corrected volume flow ▪ Carrier corrected volume flow ▪ Concentration ▪ Oscillation damping 1 ▪ Oscillation damping 2 ▪ Density ▪ Oil density ▪ Water density ▪ Dynamic viscosity ▪ Sensor electronic temperature (ISEM) ▪ GSV flow ▪ GSV flow alternative ▪ Kinematic viscosity ▪ Mass flow ▪ Oil mass flow ▪ Water mass flow ▪ Index inhomogeneous medium ▪ Index suspended bubbles ▪ HBSI ▪ NSV flow ▪ NSV flow alternative ▪ External pressure ▪ Exciter current 1 ▪ Exciter current 2 ▪ Oscillation frequency 1 ▪ Oscillation frequency 2 ▪ S&W volume flow ▪ Reference density ▪ Reference density alternative ▪ Corrected volume flow ▪ Oil corrected volume flow ▪ Water corrected volume flow ▪ Oscillation damping fluctuation 1 ▪ Oscillation damping fluctuation 2 ▪ Frequency fluctuation 1 ▪ Frequency fluctuation 2 ▪ Target mass flow ▪ Carrier volume flow ▪ Target volume flow ▪ Temp. compensated dynamic viscosity ▪ Temp. compensated kinematic viscosity ▪ Temperature ▪ Status ▪ Volume flow ▪ Oil volume flow ▪ Water volume flow ▪ Water cut 			

1) Diagnostic behavior can be changed. This causes the overall status of the measured variable to change.

12.7.2 Diagnostic of electronic

Diagnostic information		Remedy instructions	
No.	Short text		
201	Device failure	1. Restart device 2. Contact service	
	Measured variable status		
	Quality		Bad
	Quality substatus		Maintenance alarm
	Coding (hex)		0x24 to 0x27
	Status signal		F
	Diagnostic behavior		Alarm
	Influenced measured variables		
<ul style="list-style-type: none"> ▪ Oscillation amplitude 1 ▪ Oscillation amplitude 2 ▪ Application specific output ▪ Application specific output ▪ Signal asymmetry ▪ Carrier mass flow ▪ Carrier pipe temperature ▪ Target corrected volume flow ▪ Carrier corrected volume flow ▪ Concentration ▪ Measured values 1 ▪ Measured values 2 ▪ Measured values 3 ▪ Oscillation damping 1 ▪ Oscillation damping 2 ▪ Density ▪ Oil density ▪ Water density ▪ Dynamic viscosity 		<ul style="list-style-type: none"> ▪ Sensor electronic temperature (ISEM) ▪ GSV flow ▪ GSV flow alternative ▪ Kinematic viscosity ▪ Mass flow ▪ Oil mass flow ▪ Water mass flow ▪ Index inhomogeneous medium ▪ Index suspended bubbles ▪ HBSI ▪ NSV flow ▪ NSV flow alternative ▪ External pressure ▪ Exciter current 1 ▪ Exciter current 2 ▪ Oscillation frequency 1 ▪ Oscillation frequency 2 ▪ S&W volume flow ▪ Reference density 	<ul style="list-style-type: none"> ▪ Reference density alternative ▪ Corrected volume flow ▪ Oil corrected volume flow ▪ Water corrected volume flow ▪ Oscillation damping fluctuation 1 ▪ Oscillation damping fluctuation 2 ▪ Frequency fluctuation 1 ▪ Frequency fluctuation 2 ▪ Target mass flow ▪ Carrier volume flow ▪ Target volume flow ▪ Temp. compensated dynamic viscosity ▪ Temp. compensated kinematic viscosity ▪ Temperature ▪ Status ▪ Volume flow ▪ Oil volume flow ▪ Water volume flow ▪ Water cut

Diagnostic information		Remedy instructions	
No.	Short text		
242	Software incompatible	1. Check software 2. Flash or change main electronics module	
	Measured variable status		
	Quality		Bad
	Quality substatus		Maintenance alarm
	Coding (hex)		0x24 to 0x27
	Status signal		F
	Diagnostic behavior		Alarm
Influenced measured variables			
<ul style="list-style-type: none"> ▪ Oscillation amplitude 1 ▪ Oscillation amplitude 2 ▪ Application specific output ▪ Application specific output ▪ Signal asymmetry ▪ Carrier mass flow ▪ Carrier pipe temperature ▪ Target corrected volume flow ▪ Carrier corrected volume flow ▪ Concentration ▪ Measured values 1 ▪ Measured values 2 ▪ Measured values 3 ▪ Oscillation damping 1 ▪ Oscillation damping 2 ▪ Density ▪ Oil density ▪ Water density ▪ Dynamic viscosity ▪ Sensor electronic temperature (ISEM) ▪ GSV flow ▪ GSV flow alternative ▪ Kinematic viscosity ▪ Mass flow ▪ Oil mass flow ▪ Water mass flow ▪ Index inhomogeneous medium ▪ Index suspended bubbles ▪ HBSI ▪ NSV flow ▪ NSV flow alternative ▪ External pressure ▪ Exciter current 1 ▪ Exciter current 2 ▪ Oscillation frequency 1 ▪ Oscillation frequency 2 ▪ S&W volume flow ▪ Reference density ▪ Reference density alternative ▪ Corrected volume flow ▪ Oil corrected volume flow ▪ Water corrected volume flow ▪ Oscillation damping fluctuation 1 ▪ Oscillation damping fluctuation 2 ▪ Frequency fluctuation 1 ▪ Frequency fluctuation 2 ▪ Target mass flow ▪ Carrier volume flow ▪ Target volume flow ▪ Temp. compensated dynamic viscosity ▪ Temp. compensated kinematic viscosity ▪ Temperature ▪ Status ▪ Volume flow ▪ Oil volume flow ▪ Water volume flow ▪ Water cut 			

Diagnostic information		Remedy instructions	
No.	Short text		
252	Modules incompatible	1. Check electronic modules 2. Check if correct modules are available (e.g. NEx, Ex) 3. Replace electronic modules	
	Measured variable status		
	Quality		Bad
	Quality substatus		Maintenance alarm
	Coding (hex)		0x24 to 0x27
	Status signal		F
	Diagnostic behavior		Alarm
Influenced measured variables			
<ul style="list-style-type: none"> ▪ Oscillation amplitude 1 ▪ Oscillation amplitude 2 ▪ Application specific output ▪ Application specific output ▪ Signal asymmetry ▪ Carrier mass flow ▪ Carrier pipe temperature ▪ Target corrected volume flow ▪ Carrier corrected volume flow ▪ Concentration ▪ Measured values 1 ▪ Measured values 2 ▪ Measured values 3 ▪ Oscillation damping 1 ▪ Oscillation damping 2 ▪ Density ▪ Oil density ▪ Water density ▪ Dynamic viscosity ▪ Sensor electronic temperature (ISEM) ▪ GSV flow ▪ GSV flow alternative ▪ Kinematic viscosity ▪ Mass flow ▪ Oil mass flow ▪ Water mass flow ▪ Index inhomogeneous medium ▪ Index suspended bubbles ▪ HBSI ▪ NSV flow ▪ NSV flow alternative ▪ External pressure ▪ Exciter current 1 ▪ Exciter current 2 ▪ Oscillation frequency 1 ▪ Oscillation frequency 2 ▪ S&W volume flow ▪ Reference density ▪ Reference density alternative ▪ Corrected volume flow ▪ Oil corrected volume flow ▪ Water corrected volume flow ▪ Oscillation damping fluctuation 1 ▪ Oscillation damping fluctuation 2 ▪ Frequency fluctuation 1 ▪ Frequency fluctuation 2 ▪ Target mass flow ▪ Carrier volume flow ▪ Target volume flow ▪ Temp. compensated dynamic viscosity ▪ Temp. compensated kinematic viscosity ▪ Temperature ▪ Status ▪ Volume flow ▪ Oil volume flow ▪ Water volume flow ▪ Water cut 			

Diagnostic information		Remedy instructions	
No.	Short text		
252	Modules incompatible	1. Check if correct electronic modul is plugged 2. Replace electronic module	
	Measured variable status		
	Quality		Bad
	Quality substatus		Maintenance alarm
	Coding (hex)		0x24 to 0x27
	Status signal		F
	Diagnostic behavior		Alarm
Influenced measured variables			
<ul style="list-style-type: none"> ▪ Oscillation amplitude 1 ▪ Oscillation amplitude 2 ▪ Application specific output ▪ Application specific output ▪ Signal asymmetry ▪ Carrier mass flow ▪ Carrier pipe temperature ▪ Concentration ▪ Measured values 1 ▪ Measured values 2 ▪ Measured values 3 ▪ Oscillation damping 1 ▪ Oscillation damping 2 ▪ Density ▪ Dynamic viscosity ▪ Sensor electronic temperature (ISEM) ▪ Kinematic viscosity ▪ Mass flow ▪ Index inhomogeneous medium ▪ Index suspended bubbles ▪ HBSI ▪ External pressure ▪ Exciter current 1 ▪ Exciter current 2 ▪ Oscillation frequency 1 ▪ Oscillation frequency 2 ▪ Reference density ▪ Corrected volume flow ▪ Oscillation damping fluctuation 1 ▪ Oscillation damping fluctuation 2 ▪ Frequency fluctuation 1 ▪ Frequency fluctuation 2 ▪ Target mass flow ▪ Temp. compensated dynamic viscosity ▪ Temp. compensated kinematic viscosity ▪ Temperature ▪ Status ▪ Volume flow 			

Diagnostic information		Remedy instructions	
No.	Short text		
262	Sensor electronic connection faulty	1. Check or replace connection cable between sensor electronic module (ISEM) and main electronics 2. Check or replace ISEM or main electronics	
	Measured variable status		
	Quality		Bad
	Quality substatus		Maintenance alarm
	Coding (hex)		0x24 to 0x27
	Status signal		F
	Diagnostic behavior		Alarm
Influenced measured variables			
<ul style="list-style-type: none"> ▪ Oscillation amplitude 1 ▪ Oscillation amplitude 2 ▪ Application specific output ▪ Application specific output ▪ Signal asymmetry ▪ Carrier mass flow ▪ Carrier pipe temperature ▪ Target corrected volume flow ▪ Carrier corrected volume flow ▪ Concentration ▪ Measured values 1 ▪ Measured values 2 ▪ Measured values 3 ▪ Oscillation damping 1 ▪ Oscillation damping 2 ▪ Density ▪ Oil density ▪ Water density ▪ Dynamic viscosity ▪ Sensor electronic temperature (ISEM) ▪ GSV flow ▪ GSV flow alternative ▪ Kinematic viscosity ▪ Mass flow ▪ Oil mass flow ▪ Water mass flow ▪ Index inhomogeneous medium ▪ Index suspended bubbles ▪ HBSI ▪ NSV flow ▪ NSV flow alternative ▪ External pressure ▪ Exciter current 1 ▪ Exciter current 2 ▪ Oscillation frequency 1 ▪ Oscillation frequency 2 ▪ S&W volume flow ▪ Reference density ▪ Reference density alternative ▪ Corrected volume flow ▪ Oil corrected volume flow ▪ Water corrected volume flow ▪ Oscillation damping fluctuation 1 ▪ Oscillation damping fluctuation 2 ▪ Frequency fluctuation 1 ▪ Frequency fluctuation 2 ▪ Target mass flow ▪ Carrier volume flow ▪ Target volume flow ▪ Temp. compensated dynamic viscosity ▪ Temp. compensated kinematic viscosity ▪ Temperature ▪ Status ▪ Volume flow ▪ Oil volume flow ▪ Water volume flow ▪ Water cut 			

Diagnostic information		Remedy instructions
No.	Short text	
270	Main electronic failure	Change main electronic module
Measured variable status		
Quality	Bad	
Quality substatus	Maintenance alarm	
Coding (hex)	0x24 to 0x27	
Status signal	F	
Diagnostic behavior	Alarm	
Influenced measured variables		
<ul style="list-style-type: none"> ▪ Oscillation amplitude 1 ▪ Oscillation amplitude 2 ▪ Application specific output ▪ Application specific output ▪ Signal asymmetry ▪ Carrier mass flow ▪ Carrier pipe temperature ▪ Target corrected volume flow ▪ Carrier corrected volume flow ▪ Concentration ▪ Measured values 1 ▪ Measured values 2 ▪ Measured values 3 ▪ Oscillation damping 1 ▪ Oscillation damping 2 ▪ Density ▪ Oil density ▪ Water density ▪ Dynamic viscosity 		<ul style="list-style-type: none"> ▪ Sensor electronic temperature (ISEM) ▪ GSV flow ▪ GSV flow alternative ▪ Kinematic viscosity ▪ Mass flow ▪ Oil mass flow ▪ Water mass flow ▪ Index inhomogeneous medium ▪ Index suspended bubbles ▪ HBSI ▪ NSV flow ▪ NSV flow alternative ▪ External pressure ▪ Exciter current 1 ▪ Exciter current 2 ▪ Oscillation frequency 1 ▪ Oscillation frequency 2 ▪ S&W volume flow ▪ Reference density
		<ul style="list-style-type: none"> ▪ Reference density alternative ▪ Corrected volume flow ▪ Oil corrected volume flow ▪ Water corrected volume flow ▪ Oscillation damping fluctuation 1 ▪ Oscillation damping fluctuation 2 ▪ Frequency fluctuation 1 ▪ Frequency fluctuation 2 ▪ Target mass flow ▪ Carrier volume flow ▪ Target volume flow ▪ Temp. compensated dynamic viscosity ▪ Temp. compensated kinematic viscosity ▪ Temperature ▪ Status ▪ Volume flow ▪ Oil volume flow ▪ Water volume flow ▪ Water cut

Diagnostic information		Remedy instructions	
No.	Short text		
271	Main electronic failure	1. Restart device 2. Change main electronic module	
	Measured variable status		
	Quality		Bad
	Quality substatus		Maintenance alarm
	Coding (hex)		0x24 to 0x27
	Status signal		F
	Diagnostic behavior		Alarm
Influenced measured variables			
<ul style="list-style-type: none"> ▪ Oscillation amplitude 1 ▪ Oscillation amplitude 2 ▪ Application specific output ▪ Application specific output ▪ Signal asymmetry ▪ Carrier mass flow ▪ Carrier pipe temperature ▪ Target corrected volume flow ▪ Carrier corrected volume flow ▪ Concentration ▪ Measured values 1 ▪ Measured values 2 ▪ Measured values 3 ▪ Oscillation damping 1 ▪ Oscillation damping 2 ▪ Density ▪ Oil density ▪ Water density ▪ Dynamic viscosity ▪ Sensor electronic temperature (ISEM) ▪ GSV flow ▪ GSV flow alternative ▪ Kinematic viscosity ▪ Mass flow ▪ Oil mass flow ▪ Water mass flow ▪ Index inhomogeneous medium ▪ Index suspended bubbles ▪ HBSI ▪ NSV flow ▪ NSV flow alternative ▪ External pressure ▪ Exciter current 1 ▪ Exciter current 2 ▪ Oscillation frequency 1 ▪ Oscillation frequency 2 ▪ S&W volume flow ▪ Reference density ▪ Reference density alternative ▪ Corrected volume flow ▪ Oil corrected volume flow ▪ Water corrected volume flow ▪ Oscillation damping fluctuation 1 ▪ Oscillation damping fluctuation 2 ▪ Frequency fluctuation 1 ▪ Frequency fluctuation 2 ▪ Target mass flow ▪ Carrier volume flow ▪ Target volume flow ▪ Temp. compensated dynamic viscosity ▪ Temp. compensated kinematic viscosity ▪ Temperature ▪ Status ▪ Volume flow ▪ Oil volume flow ▪ Water volume flow ▪ Water cut 			

Diagnostic information		Remedy instructions	
No.	Short text		
272	Main electronic failure	1. Restart device 2. Contact service	
	Measured variable status		
	Quality	Bad	
	Quality substatus	Maintenance alarm	
	Coding (hex)	0x24 to 0x27	
	Status signal	F	
	Diagnostic behavior	Alarm	
	Influenced measured variables		
	<ul style="list-style-type: none"> ▪ Oscillation amplitude 1 ▪ Oscillation amplitude 2 ▪ Application specific output ▪ Application specific output ▪ Signal asymmetry ▪ Carrier mass flow ▪ Carrier pipe temperature ▪ Target corrected volume flow ▪ Carrier corrected volume flow ▪ Concentration ▪ Measured values 1 ▪ Measured values 2 ▪ Measured values 3 ▪ Oscillation damping 1 ▪ Oscillation damping 2 ▪ Density ▪ Oil density ▪ Water density ▪ Dynamic viscosity 	<ul style="list-style-type: none"> ▪ Sensor electronic temperature (ISEM) ▪ GSV flow ▪ GSV flow alternative ▪ Kinematic viscosity ▪ Mass flow ▪ Oil mass flow ▪ Water mass flow ▪ Index inhomogeneous medium ▪ Index suspended bubbles ▪ HBSI ▪ NSV flow ▪ NSV flow alternative ▪ External pressure ▪ Exciter current 1 ▪ Exciter current 2 ▪ Oscillation frequency 1 ▪ Oscillation frequency 2 ▪ S&W volume flow ▪ Reference density 	<ul style="list-style-type: none"> ▪ Reference density alternative ▪ Corrected volume flow ▪ Oil corrected volume flow ▪ Water corrected volume flow ▪ Oscillation damping fluctuation 1 ▪ Oscillation damping fluctuation 2 ▪ Frequency fluctuation 1 ▪ Frequency fluctuation 2 ▪ Target mass flow ▪ Carrier volume flow ▪ Target volume flow ▪ Temp. compensated dynamic viscosity ▪ Temp. compensated kinematic viscosity ▪ Temperature ▪ Status ▪ Volume flow ▪ Oil volume flow ▪ Water volume flow ▪ Water cut

Diagnostic information		Remedy instructions	
No.	Short text		
273	Main electronic failure	Change electronic	
	Measured variable status		
	Quality		Bad
	Quality substatus		Maintenance alarm
	Coding (hex)		0x24 to 0x27
	Status signal		F
	Diagnostic behavior		Alarm
Influenced measured variables			
<ul style="list-style-type: none"> ▪ Oscillation amplitude 1 ▪ Oscillation amplitude 2 ▪ Application specific output ▪ Application specific output ▪ Signal asymmetry ▪ Carrier mass flow ▪ Carrier pipe temperature ▪ Target corrected volume flow ▪ Carrier corrected volume flow ▪ Concentration ▪ Measured values 1 ▪ Measured values 2 ▪ Measured values 3 ▪ Oscillation damping 1 ▪ Oscillation damping 2 ▪ Density ▪ Oil density ▪ Water density ▪ Dynamic viscosity 			
<ul style="list-style-type: none"> ▪ Sensor electronic temperature (ISEM) ▪ GSV flow ▪ GSV flow alternative ▪ Kinematic viscosity ▪ Mass flow ▪ Oil mass flow ▪ Water mass flow ▪ Index inhomogeneous medium ▪ Index suspended bubbles ▪ HBSI ▪ NSV flow ▪ NSV flow alternative ▪ External pressure ▪ Exciter current 1 ▪ Exciter current 2 ▪ Oscillation frequency 1 ▪ Oscillation frequency 2 ▪ S&W volume flow ▪ Reference density 			
<ul style="list-style-type: none"> ▪ Reference density alternative ▪ Corrected volume flow ▪ Oil corrected volume flow ▪ Water corrected volume flow ▪ Oscillation damping fluctuation 1 ▪ Oscillation damping fluctuation 2 ▪ Frequency fluctuation 1 ▪ Frequency fluctuation 2 ▪ Target mass flow ▪ Carrier volume flow ▪ Target volume flow ▪ Temp. compensated dynamic viscosity ▪ Temp. compensated kinematic viscosity ▪ Temperature ▪ Status ▪ Volume flow ▪ Oil volume flow ▪ Water volume flow ▪ Water cut 			

Diagnostic information		Remedy instructions	
No.	Short text		
275	I/O module 1 to n defective	Change I/O module	
	Measured variable status		
	Quality		Bad
	Quality substatus		Maintenance alarm
	Coding (hex)		0x24 to 0x27
	Status signal		F
	Diagnostic behavior		Alarm
Influenced measured variables			
<ul style="list-style-type: none"> ▪ Oscillation amplitude 1 ▪ Oscillation amplitude 2 ▪ Application specific output ▪ Application specific output ▪ Signal asymmetry ▪ Carrier mass flow ▪ Carrier pipe temperature ▪ Concentration ▪ Measured values 1 ▪ Measured values 2 ▪ Measured values 3 ▪ Oscillation damping 1 ▪ Oscillation damping 2 			
<ul style="list-style-type: none"> ▪ Density ▪ Dynamic viscosity ▪ Sensor electronic temperature (ISEM) ▪ Kinematic viscosity ▪ Mass flow ▪ Index inhomogeneous medium ▪ Index suspended bubbles ▪ HBSI ▪ External pressure ▪ Exciter current 1 ▪ Exciter current 2 ▪ Oscillation frequency 1 ▪ Oscillation frequency 2 			
<ul style="list-style-type: none"> ▪ Reference density ▪ Corrected volume flow ▪ Oscillation damping fluctuation 1 ▪ Oscillation damping fluctuation 2 ▪ Frequency fluctuation 1 ▪ Frequency fluctuation 2 ▪ Target mass flow ▪ Temp. compensated dynamic viscosity ▪ Temp. compensated kinematic viscosity ▪ Temperature ▪ Status ▪ Volume flow 			

Diagnostic information		Remedy instructions	
No.	Short text		
276	I/O module 1 to n faulty	1. Restart device 2. Change I/O module	
	Measured variable status		
	Quality		Bad
	Quality substatus		Maintenance alarm
	Coding (hex)		0x24 to 0x27
	Status signal		F
	Diagnostic behavior		Alarm
Influenced measured variables			
<ul style="list-style-type: none"> ▪ Oscillation amplitude 1 ▪ Oscillation amplitude 2 ▪ Application specific output ▪ Application specific output ▪ Signal asymmetry ▪ Carrier mass flow ▪ Carrier pipe temperature ▪ Target corrected volume flow ▪ Carrier corrected volume flow ▪ Concentration ▪ Measured values 1 ▪ Measured values 2 ▪ Measured values 3 ▪ Oscillation damping 1 ▪ Oscillation damping 2 ▪ Density ▪ Dynamic viscosity ▪ Sensor electronic temperature (ISEM) ▪ Kinematic viscosity ▪ Mass flow ▪ Index inhomogeneous medium ▪ Index suspended bubbles ▪ HBSI ▪ External pressure ▪ Exciter current 1 ▪ Exciter current 2 ▪ Oscillation frequency 1 ▪ Oscillation frequency 2 ▪ Reference density ▪ Corrected volume flow ▪ Oscillation damping fluctuation 1 ▪ Oscillation damping fluctuation 2 ▪ Frequency fluctuation 1 ▪ Frequency fluctuation 2 ▪ Target mass flow ▪ Carrier volume flow ▪ Target volume flow ▪ Temp. compensated dynamic viscosity ▪ Temp. compensated kinematic viscosity ▪ Temperature ▪ Status ▪ Volume flow 			

Diagnostic information		Remedy instructions	
No.	Short text		
283	Memory content	1. Reset device 2. Contact service	
	Measured variable status		
	Quality		Bad
	Quality substatus		Maintenance alarm
	Coding (hex)		0x24 to 0x27
	Status signal		F
	Diagnostic behavior		Alarm
Influenced measured variables			
<ul style="list-style-type: none"> ▪ Oscillation amplitude 1 ▪ Oscillation amplitude 2 ▪ Application specific output ▪ Application specific output ▪ Signal asymmetry ▪ Carrier mass flow ▪ Carrier pipe temperature ▪ Target corrected volume flow ▪ Carrier corrected volume flow ▪ Concentration ▪ Measured values 1 ▪ Measured values 2 ▪ Measured values 3 ▪ Oscillation damping 1 ▪ Oscillation damping 2 ▪ Density ▪ Oil density ▪ Water density ▪ Dynamic viscosity ▪ Sensor electronic temperature (ISEM) ▪ GSV flow ▪ GSV flow alternative ▪ Kinematic viscosity ▪ Mass flow ▪ Oil mass flow ▪ Water mass flow ▪ Index inhomogeneous medium ▪ Index suspended bubbles ▪ HBSI ▪ NSV flow ▪ NSV flow alternative ▪ External pressure ▪ Exciter current 1 ▪ Exciter current 2 ▪ Oscillation frequency 1 ▪ Oscillation frequency 2 ▪ S&W volume flow ▪ Reference density ▪ Reference density alternative ▪ Corrected volume flow ▪ Oil corrected volume flow ▪ Water corrected volume flow ▪ Oscillation damping fluctuation 1 ▪ Oscillation damping fluctuation 2 ▪ Frequency fluctuation 1 ▪ Frequency fluctuation 2 ▪ Target mass flow ▪ Carrier volume flow ▪ Target volume flow ▪ Temp. compensated dynamic viscosity ▪ Temp. compensated kinematic viscosity ▪ Temperature ▪ Status ▪ Volume flow ▪ Oil volume flow ▪ Water volume flow ▪ Water cut 			

Diagnostic information		Remedy instructions	
No.	Short text		
302	Device verification active	Device verification active, please wait.	
	Measured variable status		
	Quality		Good
	Quality substatus		Function check
	Coding (hex)		0xBC to 0xBF
	Status signal		C
	Diagnostic behavior		Warning
Influenced measured variables			
<ul style="list-style-type: none"> ▪ Oscillation amplitude 1 ▪ Oscillation amplitude 2 ▪ Application specific output ▪ Application specific output ▪ Signal asymmetry ▪ Carrier mass flow ▪ Carrier pipe temperature ▪ Target corrected volume flow ▪ Carrier corrected volume flow ▪ Concentration ▪ Measured values 1 ▪ Measured values 2 ▪ Measured values 3 ▪ Oscillation damping 1 ▪ Oscillation damping 2 ▪ Density ▪ Oil density ▪ Water density ▪ Dynamic viscosity 		<ul style="list-style-type: none"> ▪ Sensor electronic temperature (ISEM) ▪ GSV flow ▪ GSV flow alternative ▪ Kinematic viscosity ▪ Mass flow ▪ Oil mass flow ▪ Water mass flow ▪ Index inhomogeneous medium ▪ Index suspended bubbles ▪ HBSI ▪ NSV flow ▪ NSV flow alternative ▪ External pressure ▪ Exciter current 1 ▪ Exciter current 2 ▪ Oscillation frequency 1 ▪ Oscillation frequency 2 ▪ S&W volume flow ▪ Reference density 	
		<ul style="list-style-type: none"> ▪ Reference density alternative ▪ Corrected volume flow ▪ Oil corrected volume flow ▪ Water corrected volume flow ▪ Oscillation damping fluctuation 1 ▪ Oscillation damping fluctuation 2 ▪ Frequency fluctuation 1 ▪ Frequency fluctuation 2 ▪ Target mass flow ▪ Carrier volume flow ▪ Target volume flow ▪ Temp. compensated dynamic viscosity ▪ Temp. compensated kinematic viscosity ▪ Temperature ▪ Status ▪ Volume flow ▪ Oil volume flow ▪ Water volume flow ▪ Water cut 	

Diagnostic information		Remedy instructions	
No.	Short text		
303	I/O 1 to n configuration changed	1. Apply I/O module configuration (parameter 'Apply I/O configuration') 2. Afterwards reload device description and check wiring	
	Measured variable status		
	Quality		Good
	Quality substatus		Ok
	Coding (hex)		0x80 to 0x83
	Status signal		M
	Diagnostic behavior		Warning
Influenced measured variables			
-			

Diagnostic information		Remedy instructions	
No.	Short text		
311	Electronic failure	1. Do not reset device 2. Contact service	
	Measured variable status		
	Quality		Bad
	Quality substatus		Maintenance alarm
	Coding (hex)		0x24 to 0x27
	Status signal		M
	Diagnostic behavior		Warning
Influenced measured variables			
<ul style="list-style-type: none"> ▪ Oscillation amplitude 1 ▪ Oscillation amplitude 2 ▪ Application specific output ▪ Application specific output ▪ Signal asymmetry ▪ Carrier mass flow ▪ Carrier pipe temperature ▪ Target corrected volume flow ▪ Carrier corrected volume flow ▪ Concentration ▪ Measured values 1 ▪ Measured values 2 ▪ Measured values 3 ▪ Oscillation damping 1 ▪ Oscillation damping 2 ▪ Density ▪ Oil density ▪ Water density ▪ Dynamic viscosity ▪ Sensor electronic temperature (ISEM) ▪ GSV flow ▪ GSV flow alternative ▪ Kinematic viscosity ▪ Mass flow ▪ Oil mass flow ▪ Water mass flow ▪ Index inhomogeneous medium ▪ Index suspended bubbles ▪ HBSI ▪ NSV flow ▪ NSV flow alternative ▪ External pressure ▪ Exciter current 1 ▪ Exciter current 2 ▪ Oscillation frequency 1 ▪ Oscillation frequency 2 ▪ S&W volume flow ▪ Reference density ▪ Reference density alternative ▪ Corrected volume flow ▪ Oil corrected volume flow ▪ Water corrected volume flow ▪ Oscillation damping fluctuation 1 ▪ Oscillation damping fluctuation 2 ▪ Frequency fluctuation 1 ▪ Frequency fluctuation 2 ▪ Target mass flow ▪ Carrier volume flow ▪ Target volume flow ▪ Temp. compensated dynamic viscosity ▪ Temp. compensated kinematic viscosity ▪ Temperature ▪ Status ▪ Volume flow ▪ Oil volume flow ▪ Water volume flow ▪ Water cut 			

Diagnostic information		Remedy instructions	
No.	Short text		
332	Writing in HistoROM backup failed	Replace user interface board Ex d/XP: replace transmitter	
	Measured variable status		
	Quality		Bad
	Quality substatus		Maintenance alarm
	Coding (hex)		0x24 to 0x27
	Status signal		F
	Diagnostic behavior		Alarm
Influenced measured variables			
<ul style="list-style-type: none"> ▪ Oscillation amplitude 1 ▪ Oscillation amplitude 2 ▪ Application specific output ▪ Application specific output ▪ Signal asymmetry ▪ Carrier mass flow ▪ Carrier pipe temperature ▪ Target corrected volume flow ▪ Carrier corrected volume flow ▪ Concentration ▪ Oscillation damping 1 ▪ Oscillation damping 2 ▪ Density ▪ Oil density ▪ Water density ▪ Dynamic viscosity ▪ Sensor electronic temperature (ISEM) ▪ GSV flow ▪ GSV flow alternative ▪ Kinematic viscosity ▪ Mass flow ▪ Oil mass flow ▪ Water mass flow ▪ Index inhomogeneous medium ▪ Index suspended bubbles ▪ HBSI ▪ NSV flow ▪ NSV flow alternative ▪ External pressure ▪ Exciter current 1 ▪ Exciter current 2 ▪ Oscillation frequency 1 ▪ Oscillation frequency 2 ▪ S&W volume flow ▪ Reference density ▪ Reference density alternative ▪ Corrected volume flow ▪ Oil corrected volume flow ▪ Water corrected volume flow ▪ Oscillation damping fluctuation 1 ▪ Oscillation damping fluctuation 2 ▪ Frequency fluctuation 1 ▪ Frequency fluctuation 2 ▪ Target mass flow ▪ Carrier volume flow ▪ Target volume flow ▪ Temp. compensated dynamic viscosity ▪ Temp. compensated kinematic viscosity ▪ Temperature ▪ Status ▪ Volume flow ▪ Oil volume flow ▪ Water volume flow ▪ Water cut 			

Diagnostic information		Remedy instructions	
No.	Short text		
361	I/O module 1 to n faulty	1. Restart device 2. Check electronic modules 3. Change I/O Modul or main electronics	
	Measured variable status		
	Quality		Bad
	Quality substatus		Maintenance alarm
	Coding (hex)		0x24 to 0x27
	Status signal		F
	Diagnostic behavior		Alarm
Influenced measured variables			
<ul style="list-style-type: none"> ▪ Oscillation amplitude 1 ▪ Oscillation amplitude 2 ▪ Application specific output ▪ Application specific output ▪ Signal asymmetry ▪ Carrier mass flow ▪ Carrier pipe temperature ▪ Concentration ▪ Measured values 1 ▪ Measured values 2 ▪ Measured values 3 ▪ Oscillation damping 1 ▪ Oscillation damping 2 ▪ Density ▪ Dynamic viscosity ▪ Sensor electronic temperature (ISEM) ▪ Kinematic viscosity ▪ Mass flow ▪ Index inhomogeneous medium ▪ Index suspended bubbles ▪ HBSI ▪ External pressure ▪ Exciter current 1 ▪ Exciter current 2 ▪ Oscillation frequency 1 ▪ Oscillation frequency 2 ▪ Reference density ▪ Corrected volume flow ▪ Oscillation damping fluctuation 1 ▪ Oscillation damping fluctuation 2 ▪ Frequency fluctuation 1 ▪ Frequency fluctuation 2 ▪ Target mass flow ▪ Temp. compensated dynamic viscosity ▪ Temp. compensated kinematic viscosity ▪ Temperature ▪ Status ▪ Volume flow 			

Diagnostic information		Remedy instructions	
No.	Short text		
372	Sensor electronic (ISEM) faulty	1. Restart device 2. Check if failure recurs 3. Replace sensor electronic module (ISEM)	
Measured variable status			
Quality	Bad		
Quality substatus	Maintenance alarm		
Coding (hex)	0x24 to 0x27		
Status signal	F		
Diagnostic behavior	Alarm		
Influenced measured variables			
<ul style="list-style-type: none"> ▪ Oscillation amplitude 1 ▪ Oscillation amplitude 2 ▪ Application specific output ▪ Application specific output ▪ Signal asymmetry ▪ Carrier mass flow ▪ Carrier pipe temperature ▪ Target corrected volume flow ▪ Carrier corrected volume flow ▪ Concentration ▪ Measured values 1 ▪ Measured values 2 ▪ Measured values 3 ▪ Oscillation damping 1 ▪ Oscillation damping 2 ▪ Density ▪ Oil density ▪ Water density ▪ Dynamic viscosity 		<ul style="list-style-type: none"> ▪ Sensor electronic temperature (ISEM) ▪ GSV flow ▪ GSV flow alternative ▪ Kinematic viscosity ▪ Mass flow ▪ Oil mass flow ▪ Water mass flow ▪ Index inhomogeneous medium ▪ Index suspended bubbles ▪ HBSI ▪ NSV flow ▪ NSV flow alternative ▪ External pressure ▪ Exciter current 1 ▪ Exciter current 2 ▪ Oscillation frequency 1 ▪ Oscillation frequency 2 ▪ S&W volume flow ▪ Reference density 	<ul style="list-style-type: none"> ▪ Reference density alternative ▪ Corrected volume flow ▪ Oil corrected volume flow ▪ Water corrected volume flow ▪ Oscillation damping fluctuation 1 ▪ Oscillation damping fluctuation 2 ▪ Frequency fluctuation 1 ▪ Frequency fluctuation 2 ▪ Target mass flow ▪ Carrier volume flow ▪ Target volume flow ▪ Temp. compensated dynamic viscosity ▪ Temp. compensated kinematic viscosity ▪ Temperature ▪ Status ▪ Volume flow ▪ Oil volume flow ▪ Water volume flow ▪ Water cut

Diagnostic information		Remedy instructions	
No.	Short text		
373	Sensor electronic (ISEM) faulty	1. Transfer data or reset device 2. Contact service	
	Measured variable status		
	Quality		Bad
	Quality substatus		Maintenance alarm
	Coding (hex)		0x24 to 0x27
	Status signal		F
	Diagnostic behavior		Alarm
Influenced measured variables			
<ul style="list-style-type: none"> ▪ Oscillation amplitude 1 ▪ Oscillation amplitude 2 ▪ Application specific output ▪ Application specific output ▪ Signal asymmetry ▪ Carrier mass flow ▪ Carrier pipe temperature ▪ Target corrected volume flow ▪ Carrier corrected volume flow ▪ Concentration ▪ Measured values 1 ▪ Measured values 2 ▪ Measured values 3 ▪ Oscillation damping 1 ▪ Oscillation damping 2 ▪ Density ▪ Oil density ▪ Water density ▪ Dynamic viscosity 		<ul style="list-style-type: none"> ▪ Sensor electronic temperature (ISEM) ▪ GSV flow ▪ GSV flow alternative ▪ Kinematic viscosity ▪ Mass flow ▪ Oil mass flow ▪ Water mass flow ▪ Index inhomogeneous medium ▪ Index suspended bubbles ▪ HBSI ▪ NSV flow ▪ NSV flow alternative ▪ External pressure ▪ Exciter current 1 ▪ Exciter current 2 ▪ Oscillation frequency 1 ▪ Oscillation frequency 2 ▪ S&W volume flow ▪ Reference density 	
		<ul style="list-style-type: none"> ▪ Reference density alternative ▪ Corrected volume flow ▪ Oil corrected volume flow ▪ Water corrected volume flow ▪ Oscillation damping fluctuation 1 ▪ Oscillation damping fluctuation 2 ▪ Frequency fluctuation 1 ▪ Frequency fluctuation 2 ▪ Target mass flow ▪ Carrier volume flow ▪ Target volume flow ▪ Temp. compensated dynamic viscosity ▪ Temp. compensated kinematic viscosity ▪ Temperature ▪ Status ▪ Volume flow ▪ Oil volume flow ▪ Water volume flow ▪ Water cut 	

Diagnostic information		Remedy instructions	
No.	Short text		
374	Sensor electronic (ISEM) faulty	1. Restart device 2. Check if failure recurs 3. Replace sensor electronic module (ISEM)	
	Measured variable status [from the factory] ¹⁾		
	Quality		Good
	Quality substatus		Ok
	Coding (hex)		0x80 to 0x83
	Status signal		S
	Diagnostic behavior		Warning
Influenced measured variables			
<ul style="list-style-type: none"> ▪ Oscillation amplitude 1 ▪ Oscillation amplitude 2 ▪ Application specific output ▪ Application specific output ▪ Signal asymmetry ▪ Carrier mass flow ▪ Carrier pipe temperature ▪ Concentration ▪ Oscillation damping 1 ▪ Oscillation damping 2 ▪ Density ▪ Dynamic viscosity 		<ul style="list-style-type: none"> ▪ Sensor electronic temperature (ISEM) ▪ Kinematic viscosity ▪ Mass flow ▪ Index inhomogeneous medium ▪ Index suspended bubbles ▪ HBSI ▪ External pressure ▪ Exciter current 1 ▪ Exciter current 2 ▪ Oscillation frequency 1 ▪ Oscillation frequency 2 ▪ Reference density 	
		<ul style="list-style-type: none"> ▪ Corrected volume flow ▪ Oscillation damping fluctuation 1 ▪ Oscillation damping fluctuation 2 ▪ Frequency fluctuation 1 ▪ Frequency fluctuation 2 ▪ Target mass flow ▪ Temp. compensated dynamic viscosity ▪ Temp. compensated kinematic viscosity ▪ Temperature ▪ Status ▪ Volume flow 	

1) Diagnostic behavior can be changed. This causes the overall status of the measured variable to change.

Diagnostic information		Remedy instructions	
No.	Short text		
375	I/O- 1 to n communication failed	1. Restart device 2. Check if failure recurs 3. Replace module rack inclusive electronic modules	
	Measured variable status		
	Quality		Bad
	Quality substatus		Maintenance alarm
	Coding (hex)		0x24 to 0x27
	Status signal		F
	Diagnostic behavior		Alarm
Influenced measured variables			
<ul style="list-style-type: none"> ▪ Oscillation amplitude 1 ▪ Oscillation amplitude 2 ▪ Application specific output ▪ Application specific output ▪ Signal asymmetry ▪ Carrier mass flow ▪ Carrier pipe temperature ▪ Target corrected volume flow ▪ Carrier corrected volume flow ▪ Concentration ▪ Measured values 1 ▪ Measured values 2 ▪ Measured values 3 ▪ Oscillation damping 1 ▪ Oscillation damping 2 ▪ Density ▪ Oil density ▪ Water density ▪ Dynamic viscosity ▪ Sensor electronic temperature (ISEM) ▪ GSV flow ▪ GSV flow alternative ▪ Kinematic viscosity ▪ Mass flow ▪ Oil mass flow ▪ Water mass flow ▪ Index inhomogeneous medium ▪ Index suspended bubbles ▪ HBSI ▪ NSV flow ▪ NSV flow alternative ▪ External pressure ▪ Exciter current 1 ▪ Exciter current 2 ▪ Oscillation frequency 1 ▪ Oscillation frequency 2 ▪ S&W volume flow ▪ Reference density ▪ Reference density alternative ▪ Corrected volume flow ▪ Oil corrected volume flow ▪ Water corrected volume flow ▪ Oscillation damping fluctuation 1 ▪ Oscillation damping fluctuation 2 ▪ Frequency fluctuation 1 ▪ Frequency fluctuation 2 ▪ Target mass flow ▪ Carrier volume flow ▪ Target volume flow ▪ Temp. compensated dynamic viscosity ▪ Temp. compensated kinematic viscosity ▪ Temperature ▪ Status ▪ Volume flow 			

Diagnostic information		Remedy instructions	
No.	Short text		
378	Supply voltage ISEM faulty	Check supply voltage to the ISEM	
	Measured variable status		
	Quality		Good
	Quality substatus		Ok
	Coding (hex)		0x80 to 0x83
	Status signal		F
	Diagnostic behavior		Alarm
Influenced measured variables			
-			

Diagnostic information		Remedy instructions	
No.	Short text		
382	Data storage	1. Insert T-DAT 2. Replace T-DAT	
	Measured variable status		
	Quality		Bad
	Quality substatus		Maintenance alarm
	Coding (hex)		0x24 to 0x27
	Status signal		F
	Diagnostic behavior		Alarm
Influenced measured variables			
<ul style="list-style-type: none"> ▪ Oscillation amplitude 1 ▪ Oscillation amplitude 2 ▪ Application specific output ▪ Application specific output ▪ Signal asymmetry ▪ Carrier mass flow ▪ Carrier pipe temperature ▪ Target corrected volume flow ▪ Carrier corrected volume flow ▪ Concentration ▪ Measured values 1 ▪ Measured values 2 ▪ Measured values 3 ▪ Oscillation damping 1 ▪ Oscillation damping 2 ▪ Density ▪ Oil density ▪ Water density ▪ Dynamic viscosity ▪ Sensor electronic temperature (ISEM) ▪ GSV flow ▪ GSV flow alternative ▪ Kinematic viscosity ▪ Mass flow ▪ Oil mass flow ▪ Water mass flow ▪ Index inhomogeneous medium ▪ Index suspended bubbles ▪ HBSI ▪ NSV flow ▪ NSV flow alternative ▪ External pressure ▪ Exciter current 1 ▪ Exciter current 2 ▪ Oscillation frequency 1 ▪ Oscillation frequency 2 ▪ S&W volume flow ▪ Reference density ▪ Reference density alternative ▪ Corrected volume flow ▪ Oil corrected volume flow ▪ Water corrected volume flow ▪ Oscillation damping fluctuation 1 ▪ Oscillation damping fluctuation 2 ▪ Frequency fluctuation 1 ▪ Frequency fluctuation 2 ▪ Target mass flow ▪ Carrier volume flow ▪ Target volume flow ▪ Temp. compensated dynamic viscosity ▪ Temp. compensated kinematic viscosity ▪ Temperature ▪ Status ▪ Volume flow ▪ Oil volume flow ▪ Water volume flow ▪ Water cut 			

Diagnostic information		Remedy instructions	
No.	Short text		
383	Memory content	1. Restart device 2. Delete T-DAT via 'Reset device' parameter 3. Replace T-DAT	
	Measured variable status		
	Quality		Bad
	Quality substatus		Maintenance alarm
	Coding (hex)		0x24 to 0x27
	Status signal		F
	Diagnostic behavior		Alarm
Influenced measured variables			
<ul style="list-style-type: none"> ▪ Oscillation amplitude 1 ▪ Oscillation amplitude 2 ▪ Application specific output ▪ Application specific output ▪ Signal asymmetry ▪ Carrier mass flow ▪ Carrier pipe temperature ▪ Target corrected volume flow ▪ Carrier corrected volume flow ▪ Concentration ▪ Measured values 1 ▪ Measured values 2 ▪ Measured values 3 ▪ Oscillation damping 1 ▪ Oscillation damping 2 ▪ Density ▪ Oil density ▪ Water density ▪ Dynamic viscosity ▪ Sensor electronic temperature (ISEM) ▪ GSV flow ▪ GSV flow alternative ▪ Kinematic viscosity ▪ Mass flow ▪ Oil mass flow ▪ Water mass flow ▪ Index inhomogeneous medium ▪ Index suspended bubbles ▪ HBSI ▪ NSV flow ▪ NSV flow alternative ▪ External pressure ▪ Exciter current 1 ▪ Exciter current 2 ▪ Oscillation frequency 1 ▪ Oscillation frequency 2 ▪ S&W volume flow ▪ Reference density ▪ Reference density alternative ▪ Corrected volume flow ▪ Oil corrected volume flow ▪ Water corrected volume flow ▪ Oscillation damping fluctuation 1 ▪ Oscillation damping fluctuation 2 ▪ Frequency fluctuation 1 ▪ Frequency fluctuation 2 ▪ Target mass flow ▪ Carrier volume flow ▪ Target volume flow ▪ Temp. compensated dynamic viscosity ▪ Temp. compensated kinematic viscosity ▪ Temperature ▪ Status ▪ Volume flow 			

Diagnostic information		Remedy instructions	
No.	Short text		
387	HistoROM data faulty	Contact service organization	
	Measured variable status		
	Quality		Bad
	Quality substatus		Maintenance alarm
	Coding (hex)		0x24 to 0x27
	Status signal		F
	Diagnostic behavior		Alarm
Influenced measured variables			
<ul style="list-style-type: none"> ▪ Oscillation amplitude 1 ▪ Oscillation amplitude 2 ▪ Application specific output ▪ Application specific output ▪ Signal asymmetry ▪ Carrier mass flow ▪ Carrier pipe temperature ▪ Target corrected volume flow ▪ Carrier corrected volume flow ▪ Concentration ▪ Measured values 1 ▪ Measured values 2 ▪ Measured values 3 ▪ Oscillation damping 1 ▪ Oscillation damping 2 ▪ Density ▪ Oil density ▪ Water density ▪ Dynamic viscosity 		<ul style="list-style-type: none"> ▪ Sensor electronic temperature (ISEM) ▪ GSV flow ▪ GSV flow alternative ▪ Kinematic viscosity ▪ Mass flow ▪ Oil mass flow ▪ Water mass flow ▪ Index inhomogeneous medium ▪ Index suspended bubbles ▪ HBSI ▪ NSV flow ▪ NSV flow alternative ▪ External pressure ▪ Exciter current 1 ▪ Exciter current 2 ▪ Oscillation frequency 1 ▪ Oscillation frequency 2 ▪ S&W volume flow ▪ Reference density 	
		<ul style="list-style-type: none"> ▪ Reference density alternative ▪ Corrected volume flow ▪ Oil corrected volume flow ▪ Water corrected volume flow ▪ Oscillation damping fluctuation 1 ▪ Oscillation damping fluctuation 2 ▪ Frequency fluctuation 1 ▪ Frequency fluctuation 2 ▪ Target mass flow ▪ Carrier volume flow ▪ Target volume flow ▪ Temp. compensated dynamic viscosity ▪ Temp. compensated kinematic viscosity ▪ Temperature ▪ Status ▪ Volume flow ▪ Oil volume flow ▪ Water volume flow ▪ Water cut 	

12.7.3 Diagnostic of configuration

Diagnostic information		Remedy instructions	
No.	Short text		
330	Flash file invalid	1. Update firmware of device 2. Restart device	
	Measured variable status		
	Quality		Bad
	Quality substatus		Maintenance alarm
	Coding (hex)		0x24 to 0x27
	Status signal		M
	Diagnostic behavior		Warning
Influenced measured variables			
<ul style="list-style-type: none"> ▪ Oscillation amplitude 1 ▪ Oscillation amplitude 2 ▪ Application specific output ▪ Application specific output ▪ Signal asymmetry ▪ Carrier mass flow ▪ Carrier pipe temperature ▪ Concentration ▪ Measured values 1 ▪ Measured values 2 ▪ Measured values 3 ▪ Oscillation damping 1 ▪ Oscillation damping 2 		<ul style="list-style-type: none"> ▪ Density ▪ Dynamic viscosity ▪ Sensor electronic temperature (ISEM) ▪ Kinematic viscosity ▪ Mass flow ▪ Index inhomogeneous medium ▪ Index suspended bubbles ▪ HBSI ▪ External pressure ▪ Exciter current 1 ▪ Exciter current 2 ▪ Oscillation frequency 1 ▪ Oscillation frequency 2 	
		<ul style="list-style-type: none"> ▪ Reference density ▪ Corrected volume flow ▪ Oscillation damping fluctuation 1 ▪ Oscillation damping fluctuation 2 ▪ Frequency fluctuation 1 ▪ Frequency fluctuation 2 ▪ Target mass flow ▪ Temp. compensated dynamic viscosity ▪ Temp. compensated kinematic viscosity ▪ Temperature ▪ Status ▪ Volume flow 	

Diagnostic information		Remedy instructions
No.	Short text	
331	Firmware update failed	1. Update firmware of device 2. Restart device
Measured variable status		
Quality	Bad	
Quality substatus	Maintenance alarm	
Coding (hex)	0x24 to 0x27	
Status signal	F	
Diagnostic behavior	Warning	
Influenced measured variables		
<ul style="list-style-type: none"> ▪ Oscillation amplitude 1 ▪ Oscillation amplitude 2 ▪ Application specific output ▪ Application specific output ▪ Signal asymmetry ▪ Carrier mass flow ▪ Carrier pipe temperature ▪ Target corrected volume flow ▪ Carrier corrected volume flow ▪ Concentration ▪ Measured values 1 ▪ Measured values 2 ▪ Measured values 3 ▪ Oscillation damping 1 ▪ Oscillation damping 2 ▪ Density ▪ Oil density ▪ Water density ▪ Dynamic viscosity 		<ul style="list-style-type: none"> ▪ Sensor electronic temperature (ISEM) ▪ GSV flow ▪ GSV flow alternative ▪ Kinematic viscosity ▪ Mass flow ▪ Oil mass flow ▪ Water mass flow ▪ Index inhomogeneous medium ▪ Index suspended bubbles ▪ HBSI ▪ NSV flow ▪ NSV flow alternative ▪ External pressure ▪ Exciter current 1 ▪ Exciter current 2 ▪ Oscillation frequency 1 ▪ Oscillation frequency 2 ▪ S&W volume flow ▪ Reference density
		<ul style="list-style-type: none"> ▪ Reference density alternative ▪ Corrected volume flow ▪ Oil corrected volume flow ▪ Water corrected volume flow ▪ Oscillation damping fluctuation 1 ▪ Oscillation damping fluctuation 2 ▪ Frequency fluctuation 1 ▪ Frequency fluctuation 2 ▪ Target mass flow ▪ Carrier volume flow ▪ Target volume flow ▪ Temp. compensated dynamic viscosity ▪ Temp. compensated kinematic viscosity ▪ Temperature ▪ Status ▪ Volume flow ▪ Oil volume flow ▪ Water volume flow ▪ Water cut

Diagnostic information		Remedy instructions	
No.	Short text		
410	Data transfer	1. Check connection 2. Retry data transfer	
	Measured variable status		
	Quality		Bad
	Quality substatus		Maintenance alarm
	Coding (hex)		0x24 to 0x27
	Status signal		F
	Diagnostic behavior		Alarm
Influenced measured variables			
<ul style="list-style-type: none"> ▪ Oscillation amplitude 1 ▪ Oscillation amplitude 2 ▪ Application specific output ▪ Application specific output ▪ Signal asymmetry ▪ Carrier mass flow ▪ Carrier pipe temperature ▪ Target corrected volume flow ▪ Carrier corrected volume flow ▪ Concentration ▪ Measured values 1 ▪ Measured values 2 ▪ Measured values 3 ▪ Oscillation damping 1 ▪ Oscillation damping 2 ▪ Density ▪ Oil density ▪ Water density ▪ Dynamic viscosity ▪ Sensor electronic temperature (ISEM) ▪ GSV flow ▪ GSV flow alternative ▪ Kinematic viscosity ▪ Mass flow ▪ Oil mass flow ▪ Water mass flow ▪ Index inhomogeneous medium ▪ Index suspended bubbles ▪ HBSI ▪ NSV flow ▪ NSV flow alternative ▪ External pressure ▪ Exciter current 1 ▪ Exciter current 2 ▪ Oscillation frequency 1 ▪ Oscillation frequency 2 ▪ S&W volume flow ▪ Reference density ▪ Reference density alternative ▪ Corrected volume flow ▪ Oil corrected volume flow ▪ Water corrected volume flow ▪ Oscillation damping fluctuation 1 ▪ Oscillation damping fluctuation 2 ▪ Frequency fluctuation 1 ▪ Frequency fluctuation 2 ▪ Target mass flow ▪ Carrier volume flow ▪ Target volume flow ▪ Temp. compensated dynamic viscosity ▪ Temp. compensated kinematic viscosity ▪ Temperature ▪ Status ▪ Volume flow ▪ Oil volume flow ▪ Water volume flow ▪ Water cut 			

Diagnostic information		Remedy instructions	
No.	Short text		
412	Processing download	Download active, please wait	
	Measured variable status		
	Quality		Uncertain
	Quality substatus		Initial value
	Coding (hex)		0x4C to 0x4F
	Status signal		C
	Diagnostic behavior		Warning
Influenced measured variables			
<ul style="list-style-type: none"> ▪ Oscillation amplitude 1 ▪ Oscillation amplitude 2 ▪ Application specific output ▪ Application specific output ▪ Signal asymmetry ▪ Carrier mass flow ▪ Carrier pipe temperature ▪ Target corrected volume flow ▪ Carrier corrected volume flow ▪ Concentration ▪ Measured values 1 ▪ Measured values 2 ▪ Measured values 3 ▪ Oscillation damping 1 ▪ Oscillation damping 2 ▪ Density ▪ Oil density ▪ Water density ▪ Dynamic viscosity ▪ Sensor electronic temperature (ISEM) ▪ GSV flow ▪ GSV flow alternative ▪ Kinematic viscosity ▪ Mass flow ▪ Oil mass flow ▪ Water mass flow ▪ Index inhomogeneous medium ▪ Index suspended bubbles ▪ HBSI ▪ NSV flow ▪ NSV flow alternative ▪ External pressure ▪ Exciter current 1 ▪ Exciter current 2 ▪ Oscillation frequency 1 ▪ Oscillation frequency 2 ▪ S&W volume flow ▪ Reference density ▪ Reference density alternative ▪ Corrected volume flow ▪ Oil corrected volume flow ▪ Water corrected volume flow ▪ Oscillation damping fluctuation 1 ▪ Oscillation damping fluctuation 2 ▪ Frequency fluctuation 1 ▪ Frequency fluctuation 2 ▪ Target mass flow ▪ Carrier volume flow ▪ Target volume flow ▪ Temp. compensated dynamic viscosity ▪ Temp. compensated kinematic viscosity ▪ Temperature ▪ Status ▪ Volume flow ▪ Oil volume flow ▪ Water volume flow ▪ Water cut 			

Diagnostic information		Remedy instructions	
No.	Short text		
431	Trim 1 to n	Carry out trim	
	Measured variable status		
	Quality		Good
	Quality substatus		Ok
	Coding (hex)		0x80 to 0x83
	Status signal		C
	Diagnostic behavior		Warning
Influenced measured variables			
-			

Diagnostic information		Remedy instructions	
No.	Short text		
437	Configuration incompatible	1. Restart device 2. Contact service	
	Measured variable status		
	Quality		Bad
	Quality substatus		Maintenance alarm
	Coding (hex)		0x24 to 0x27
	Status signal		F
	Diagnostic behavior		Alarm
Influenced measured variables			
<ul style="list-style-type: none"> ▪ Oscillation amplitude 1 ▪ Oscillation amplitude 2 ▪ Application specific output ▪ Application specific output ▪ Signal asymmetry ▪ Carrier mass flow ▪ Carrier pipe temperature ▪ Target corrected volume flow ▪ Carrier corrected volume flow ▪ Concentration ▪ Measured values 1 ▪ Measured values 2 ▪ Measured values 3 ▪ Oscillation damping 1 ▪ Oscillation damping 2 ▪ Density ▪ Oil density ▪ Water density ▪ Dynamic viscosity ▪ Sensor electronic temperature (ISEM) ▪ GSV flow ▪ GSV flow alternative ▪ Kinematic viscosity ▪ Mass flow ▪ Oil mass flow ▪ Water mass flow ▪ Index inhomogeneous medium ▪ Index suspended bubbles ▪ HBSI ▪ NSV flow ▪ NSV flow alternative ▪ External pressure ▪ Exciter current 1 ▪ Exciter current 2 ▪ Oscillation frequency 1 ▪ Oscillation frequency 2 ▪ S&W volume flow ▪ Reference density ▪ Reference density alternative ▪ Corrected volume flow ▪ Oil corrected volume flow ▪ Water corrected volume flow ▪ Oscillation damping fluctuation 1 ▪ Oscillation damping fluctuation 2 ▪ Frequency fluctuation 1 ▪ Frequency fluctuation 2 ▪ Target mass flow ▪ Carrier volume flow ▪ Target volume flow ▪ Temp. compensated dynamic viscosity ▪ Temp. compensated kinematic viscosity ▪ Temperature ▪ Status ▪ Volume flow ▪ Oil volume flow ▪ Water volume flow ▪ Water cut 			

Diagnostic information		Remedy instructions	
No.	Short text		
438	Dataset	1. Check data set file 2. Check device configuration 3. Up- and download new configuration	
	Measured variable status		
	Quality		Uncertain
	Quality substatus		Maintenance demanded
	Coding (hex)		0x68 to 0x6B
	Status signal		M
	Diagnostic behavior		Warning
	Influenced measured variables		
<ul style="list-style-type: none"> ▪ Oscillation amplitude 1 ▪ Oscillation amplitude 2 ▪ Application specific output ▪ Application specific output ▪ Signal asymmetry ▪ Carrier mass flow ▪ Carrier pipe temperature ▪ Target corrected volume flow ▪ Carrier corrected volume flow ▪ Concentration ▪ Measured values 1 ▪ Measured values 2 ▪ Measured values 3 ▪ Oscillation damping 1 ▪ Oscillation damping 2 ▪ Density ▪ Oil density ▪ Water density ▪ Dynamic viscosity ▪ Sensor electronic temperature (ISEM) ▪ GSV flow ▪ GSV flow alternative ▪ Kinematic viscosity ▪ Mass flow ▪ Oil mass flow ▪ Water mass flow ▪ Index inhomogeneous medium ▪ Index suspended bubbles ▪ HBSI ▪ NSV flow ▪ NSV flow alternative ▪ External pressure ▪ Exciter current 1 ▪ Exciter current 2 ▪ Oscillation frequency 1 ▪ Oscillation frequency 2 ▪ S&W volume flow ▪ Reference density ▪ Reference density alternative ▪ Corrected volume flow ▪ Oil corrected volume flow ▪ Water corrected volume flow ▪ Oscillation damping fluctuation 1 ▪ Oscillation damping fluctuation 2 ▪ Frequency fluctuation 1 ▪ Frequency fluctuation 2 ▪ Target mass flow ▪ Carrier volume flow ▪ Target volume flow ▪ Temp. compensated dynamic viscosity ▪ Temp. compensated kinematic viscosity ▪ Temperature ▪ Status ▪ Volume flow ▪ Oil volume flow ▪ Water volume flow ▪ Water cut 			

Diagnostic information		Remedy instructions	
No.	Short text		
441	Current output 1 to n	1. Check process 2. Check current output settings	
	Measured variable status [from the factory] ¹⁾		
	Quality		Good
	Quality substatus		Ok
	Coding (hex)		0x80 to 0x83
	Status signal		S
	Diagnostic behavior		Warning
	Influenced measured variables		
-			

1) Diagnostic behavior can be changed. This causes the overall status of the measured variable to change.

Diagnostic information		Remedy instructions	
No.	Short text		
442	Frequency output 1 to n	1. Check process 2. Check frequency output settings	
	Measured variable status [from the factory] ¹⁾		
	Quality		Good
	Quality substatus		Ok
	Coding (hex)		0x80 to 0x83
	Status signal		S
	Diagnostic behavior		Warning
	Influenced measured variables		
-			

1) Diagnostic behavior can be changed. This causes the overall status of the measured variable to change.

Diagnostic information		Remedy instructions	
No.	Short text		
443	Pulse output 1 to n	1. Check process 2. Check pulse output settings	
	Measured variable status [from the factory] ¹⁾		
	Quality		Good
	Quality substatus		Ok
	Coding (hex)		0x80 to 0x83
	Status signal		S
	Diagnostic behavior		Warning
	Influenced measured variables		
-			

1) Diagnostic behavior can be changed. This causes the overall status of the measured variable to change.

Diagnostic information		Remedy instructions	
No.	Short text		
444	Current input 1 to n	1. Check process 2. Check current input settings	
	Measured variable status [from the factory] ¹⁾		
	Quality		Good
	Quality substatus		Ok
	Coding (hex)		0x80 to 0x83
	Status signal		S
	Diagnostic behavior		Warning
	Influenced measured variables		
<ul style="list-style-type: none"> ■ Measured values 1 ■ Measured values 2 ■ Measured values 3 			

1) Diagnostic behavior can be changed. This causes the overall status of the measured variable to change.

Diagnostic information		Remedy instructions
No.	Short text	
453	Flow override	Deactivate flow override
Measured variable status		
Quality	Good	
Quality substatus	Function check	
Coding (hex)	0xBC to 0xBF	
Status signal	C	
Diagnostic behavior	Warning	
Influenced measured variables		
<ul style="list-style-type: none"> ▪ Oscillation amplitude 1 ▪ Oscillation amplitude 2 ▪ Application specific output ▪ Application specific output ▪ Signal asymmetry ▪ Carrier mass flow ▪ Carrier pipe temperature ▪ Target corrected volume flow ▪ Carrier corrected volume flow ▪ Concentration ▪ Oscillation damping 1 ▪ Oscillation damping 2 ▪ Density ▪ Oil density ▪ Water density ▪ Dynamic viscosity ▪ Sensor electronic temperature (ISEM) ▪ GSV flow 		<ul style="list-style-type: none"> ▪ GSV flow alternative ▪ Kinematic viscosity ▪ Mass flow ▪ Oil mass flow ▪ Water mass flow ▪ Index inhomogeneous medium ▪ Index suspended bubbles ▪ HBSI ▪ NSV flow ▪ NSV flow alternative ▪ External pressure ▪ Exciter current 1 ▪ Exciter current 2 ▪ Oscillation frequency 1 ▪ Oscillation frequency 2 ▪ S&W volume flow ▪ Reference density ▪ Reference density alternative
		<ul style="list-style-type: none"> ▪ Corrected volume flow ▪ Oil corrected volume flow ▪ Water corrected volume flow ▪ Oscillation damping fluctuation 1 ▪ Oscillation damping fluctuation 2 ▪ Frequency fluctuation 1 ▪ Frequency fluctuation 2 ▪ Target mass flow ▪ Carrier volume flow ▪ Target volume flow ▪ Temp. compensated dynamic viscosity ▪ Temp. compensated kinematic viscosity ▪ Temperature ▪ Status ▪ Volume flow ▪ Oil volume flow ▪ Water volume flow ▪ Water cut

Diagnostic information		Remedy instructions	
No.	Short text		
484	Failure mode simulation	Deactivate simulation	
	Measured variable status		
	Quality		Bad
	Quality substatus		Function check
	Coding (hex)		0x3C to 0x3F
	Status signal		C
	Diagnostic behavior		Alarm
Influenced measured variables			
<ul style="list-style-type: none"> ▪ Oscillation amplitude 1 ▪ Oscillation amplitude 2 ▪ Application specific output ▪ Application specific output ▪ Signal asymmetry ▪ Carrier mass flow ▪ Carrier pipe temperature ▪ Target corrected volume flow ▪ Carrier corrected volume flow ▪ Concentration ▪ Oscillation damping 1 ▪ Oscillation damping 2 ▪ Density ▪ Oil density ▪ Water density ▪ Dynamic viscosity ▪ Sensor electronic temperature (ISEM) ▪ GSV flow ▪ GSV flow alternative ▪ Kinematic viscosity ▪ Mass flow ▪ Oil mass flow ▪ Water mass flow ▪ Index inhomogeneous medium ▪ Index suspended bubbles ▪ HBSI ▪ NSV flow ▪ NSV flow alternative ▪ External pressure ▪ Exciter current 1 ▪ Exciter current 2 ▪ Oscillation frequency 1 ▪ Oscillation frequency 2 ▪ S&W volume flow ▪ Reference density ▪ Reference density alternative ▪ Corrected volume flow ▪ Oil corrected volume flow ▪ Water corrected volume flow ▪ Oscillation damping fluctuation 1 ▪ Oscillation damping fluctuation 2 ▪ Frequency fluctuation 1 ▪ Frequency fluctuation 2 ▪ Target mass flow ▪ Carrier volume flow ▪ Target volume flow ▪ Temp. compensated dynamic viscosity ▪ Temp. compensated kinematic viscosity ▪ Temperature ▪ Status ▪ Volume flow ▪ Oil volume flow ▪ Water volume flow ▪ Water cut 			

Diagnostic information		Remedy instructions	
No.	Short text		
485	Measured variable simulation	Deactivate simulation	
	Measured variable status		
	Quality		Good
	Quality substatus		Function check
	Coding (hex)		0xBC to 0xBF
	Status signal		C
	Diagnostic behavior		Warning
Influenced measured variables			
<ul style="list-style-type: none"> ▪ Oscillation amplitude 1 ▪ Oscillation amplitude 2 ▪ Application specific output ▪ Application specific output ▪ Signal asymmetry ▪ Carrier mass flow ▪ Carrier pipe temperature ▪ Target corrected volume flow ▪ Carrier corrected volume flow ▪ Concentration ▪ Oscillation damping 1 ▪ Oscillation damping 2 ▪ Density ▪ Oil density ▪ Water density ▪ Dynamic viscosity ▪ Sensor electronic temperature (ISEM) ▪ GSV flow ▪ GSV flow alternative ▪ Kinematic viscosity ▪ Mass flow ▪ Oil mass flow ▪ Water mass flow ▪ Index inhomogeneous medium ▪ Index suspended bubbles ▪ HBSI ▪ NSV flow ▪ NSV flow alternative ▪ External pressure ▪ Exciter current 1 ▪ Exciter current 2 ▪ Oscillation frequency 1 ▪ Oscillation frequency 2 ▪ S&W volume flow ▪ Reference density ▪ Reference density alternative ▪ Corrected volume flow ▪ Oil corrected volume flow ▪ Water corrected volume flow ▪ Oscillation damping fluctuation 1 ▪ Oscillation damping fluctuation 2 ▪ Frequency fluctuation 1 ▪ Frequency fluctuation 2 ▪ Target mass flow ▪ Carrier volume flow ▪ Target volume flow ▪ Temp. compensated dynamic viscosity ▪ Temp. compensated kinematic viscosity ▪ Temperature ▪ Status ▪ Volume flow ▪ Oil volume flow ▪ Water volume flow ▪ Water cut 			

Diagnostic information		Remedy instructions	
No.	Short text		
486	Current input 1 to n simulation	Deactivate simulation	
	Measured variable status		
	Quality		Good
	Quality substatus		Function check
	Coding (hex)		0xBC to 0xBF
	Status signal		C
	Diagnostic behavior		Warning
Influenced measured variables			
<ul style="list-style-type: none"> ▪ Measured values 1 ▪ Measured values 2 ▪ Measured values 3 			

Diagnostic information		Remedy instructions	
No.	Short text		
491	Current output 1 to n simulation	Deactivate simulation	
	Measured variable status		
	Quality		Good
	Quality substatus		Ok
	Coding (hex)		0x80 to 0x83
	Status signal		C
	Diagnostic behavior		Warning
	Influenced measured variables		
-			

Diagnostic information		Remedy instructions	
No.	Short text		
492	Simulation frequency output 1 to n	Deactivate simulation frequency output	
	Measured variable status		
	Quality		Good
	Quality substatus		Ok
	Coding (hex)		0x80 to 0x83
	Status signal		C
	Diagnostic behavior		Warning
	Influenced measured variables		
-			

Diagnostic information		Remedy instructions	
No.	Short text		
493	Simulation pulse output 1 to n	Deactivate simulation pulse output	
	Measured variable status		
	Quality		Good
	Quality substatus		Ok
	Coding (hex)		0x80 to 0x83
	Status signal		C
	Diagnostic behavior		Warning
	Influenced measured variables		
-			

Diagnostic information		Remedy instructions	
No.	Short text		
494	Switch output simulation 1 to n	Deactivate simulation switch output	
	Measured variable status		
	Quality		Good
	Quality substatus		Ok
	Coding (hex)		0x80 to 0x83
	Status signal		C
	Diagnostic behavior		Warning
	Influenced measured variables		
-			

Diagnostic information		Remedy instructions	
No.	Short text		
495	Diagnostic event simulation	Deactivate simulation	
	Measured variable status		
	Quality		Good
	Quality substatus		Ok
	Coding (hex)		0x80 to 0x83
	Status signal		C
	Diagnostic behavior		Warning
	Influenced measured variables		
-			

Diagnostic information		Remedy instructions	
No.	Short text		
496	Status input simulation	Deactivate simulation status input	
	Measured variable status		
	Quality		Good
	Quality substatus		Ok
	Coding (hex)		0x80 to 0x83
	Status signal		C
	Diagnostic behavior		Warning
	Influenced measured variables		
-			

Diagnostic information		Remedy instructions	
No.	Short text		
520	I/O 1 to n hardware configuration invalid	1. Check I/O hardware configuration 2. Replace wrong I/O module 3. Plug the module of double pulse output on correct slot	
	Measured variable status		
	Quality		Good
	Quality substatus		Ok
	Coding (hex)		0x80 to 0x83
	Status signal		F
	Diagnostic behavior		Alarm
	Influenced measured variables		
-			

Diagnostic information		Remedy instructions	
No.	Short text		
528	Concentration calculation not possible	Out of valid range of the selected calculation algorithm 1. Check concentration settings 2. Check measured values, e.g. density or temperature	
	Measured variable status		
	Quality		Bad
	Quality substatus		Function check
	Coding (hex)		0x3C to 0x3F
	Status signal		S
	Diagnostic behavior		Alarm
	Influenced measured variables		
<ul style="list-style-type: none"> ▪ Carrier mass flow ▪ Target corrected volume flow ▪ Carrier corrected volume flow ▪ Concentration ▪ Density ▪ Mass flow ▪ Target mass flow ▪ Carrier volume flow ▪ Target volume flow ▪ Volume flow 			

Diagnostic information		Remedy instructions	
No.	Short text		
529	Concentration calculation not accurate	Out of valid range of the selected calculation algorithm 1. Check concentration settings 2. Check measured values, e.g. density or temperature	
	Measured variable status		
	Quality		Bad
	Quality substatus		Function check
	Coding (hex)		0x3C to 0x3F
	Status signal		S
	Diagnostic behavior		Warning
	Influenced measured variables		
<ul style="list-style-type: none"> ▪ Carrier mass flow ▪ Target corrected volume flow ▪ Carrier corrected volume flow ▪ Concentration ▪ Density ▪ Mass flow ▪ Target mass flow ▪ Carrier volume flow ▪ Target volume flow ▪ Volume flow 			

Diagnostic information		Remedy instructions	
No.	Short text		
537	Configuration	1. Check IP addresses in network 2. Change IP address	
	Measured variable status		
	Quality		Good
	Quality substatus		Ok
	Coding (hex)		0x80 to 0x83
	Status signal		F
	Diagnostic behavior		Warning
	Influenced measured variables		
-			

Diagnostic information		Remedy instructions	
No.	Short text		
594	Relay output simulation	Deactivate simulation switch output	
	Measured variable status		
	Quality		Good
	Quality substatus		Ok
	Coding (hex)		0x80 to 0x83
	Status signal		C
	Diagnostic behavior		Warning
	Influenced measured variables		
-			

12.7.4 Diagnostic of process

Diagnostic information		Remedy instructions	
No.	Short text		
803	Current loop	1. Check wiring 2. Change I/O module	
	Measured variable status		
	Quality		Good
	Quality substatus		Ok
	Coding (hex)		0x80 to 0x83
	Status signal		F
	Diagnostic behavior		Alarm
	Influenced measured variables		
-			

Diagnostic information		Remedy instructions	
No.	Short text		
830	Sensor temperature too high	Reduce ambient temp. around the sensor housing	
	Measured variable status [from the factory] ¹⁾		
	Quality		Good
	Quality substatus		Ok
	Coding (hex)		0x80 to 0x83
	Status signal		S
	Diagnostic behavior		Warning
Influenced measured variables			
<ul style="list-style-type: none"> ▪ Oscillation amplitude 1 ▪ Oscillation amplitude 2 ▪ Application specific output ▪ Application specific output ▪ Signal asymmetry ▪ Carrier mass flow ▪ Carrier pipe temperature ▪ Target corrected volume flow ▪ Carrier corrected volume flow ▪ Concentration ▪ Oscillation damping 1 ▪ Oscillation damping 2 ▪ Density ▪ Oil density ▪ Water density ▪ Dynamic viscosity ▪ Sensor electronic temperature (ISEM) ▪ GSV flow ▪ GSV flow alternative ▪ Kinematic viscosity ▪ Mass flow ▪ Oil mass flow ▪ Water mass flow ▪ Index inhomogeneous medium ▪ Index suspended bubbles ▪ HBSI ▪ NSV flow ▪ NSV flow alternative ▪ External pressure ▪ Exciter current 1 ▪ Exciter current 2 ▪ Oscillation frequency 1 ▪ Oscillation frequency 2 ▪ S&W volume flow ▪ Reference density ▪ Reference density alternative ▪ Corrected volume flow ▪ Oil corrected volume flow ▪ Water corrected volume flow ▪ Oscillation damping fluctuation 1 ▪ Oscillation damping fluctuation 2 ▪ Frequency fluctuation 1 ▪ Frequency fluctuation 2 ▪ Target mass flow ▪ Carrier volume flow ▪ Target volume flow ▪ Temp. compensated dynamic viscosity ▪ Temp. compensated kinematic viscosity ▪ Temperature ▪ Status ▪ Volume flow ▪ Oil volume flow ▪ Water volume flow ▪ Water cut 			

1) Diagnostic behavior can be changed. This causes the overall status of the measured variable to change.

Diagnostic information		Remedy instructions
No.	Short text	
831	Sensor temperature too low	Increase ambient temp. around the sensor housing
Measured variable status [from the factory] ¹⁾		
Quality	Good	
Quality substatus	Ok	
Coding (hex)	0x80 to 0x83	
Status signal	S	
Diagnostic behavior	Warning	
Influenced measured variables		
<ul style="list-style-type: none"> ▪ Oscillation amplitude 1 ▪ Oscillation amplitude 2 ▪ Application specific output ▪ Application specific output ▪ Signal asymmetry ▪ Carrier mass flow ▪ Carrier pipe temperature ▪ Target corrected volume flow ▪ Carrier corrected volume flow ▪ Concentration ▪ Oscillation damping 1 ▪ Oscillation damping 2 ▪ Density ▪ Oil density ▪ Water density ▪ Dynamic viscosity ▪ Sensor electronic temperature (ISEM) ▪ GSV flow 		<ul style="list-style-type: none"> ▪ GSV flow alternative ▪ Kinematic viscosity ▪ Mass flow ▪ Oil mass flow ▪ Water mass flow ▪ Index inhomogeneous medium ▪ Index suspended bubbles ▪ HBSI ▪ NSV flow ▪ NSV flow alternative ▪ External pressure ▪ Exciter current 1 ▪ Exciter current 2 ▪ Oscillation frequency 1 ▪ Oscillation frequency 2 ▪ S&W volume flow ▪ Reference density ▪ Reference density alternative
		<ul style="list-style-type: none"> ▪ Corrected volume flow ▪ Oil corrected volume flow ▪ Water corrected volume flow ▪ Oscillation damping fluctuation 1 ▪ Oscillation damping fluctuation 2 ▪ Frequency fluctuation 1 ▪ Frequency fluctuation 2 ▪ Target mass flow ▪ Carrier volume flow ▪ Target volume flow ▪ Temp. compensated dynamic viscosity ▪ Temp. compensated kinematic viscosity ▪ Temperature ▪ Status ▪ Volume flow ▪ Oil volume flow ▪ Water volume flow ▪ Water cut

1) Diagnostic behavior can be changed. This causes the overall status of the measured variable to change.

Diagnostic information		Remedy instructions
No.	Short text	
832	Electronic temperature too high	Reduce ambient temperature
Measured variable status [from the factory] ¹⁾		
Quality	Good	
Quality substatus	Ok	
Coding (hex)	0x80 to 0x83	
Status signal	S	
Diagnostic behavior	Warning	
Influenced measured variables		
<ul style="list-style-type: none"> ▪ Oscillation amplitude 1 ▪ Oscillation amplitude 2 ▪ Application specific output ▪ Application specific output ▪ Signal asymmetry ▪ Carrier mass flow ▪ Carrier pipe temperature ▪ Target corrected volume flow ▪ Carrier corrected volume flow ▪ Concentration ▪ Measured values 1 ▪ Measured values 2 ▪ Measured values 3 ▪ Oscillation damping 1 ▪ Oscillation damping 2 ▪ Density ▪ Oil density ▪ Water density ▪ Dynamic viscosity 		<ul style="list-style-type: none"> ▪ Sensor electronic temperature (ISEM) ▪ GSV flow ▪ GSV flow alternative ▪ Kinematic viscosity ▪ Mass flow ▪ Oil mass flow ▪ Water mass flow ▪ Index inhomogeneous medium ▪ Index suspended bubbles ▪ HBSI ▪ NSV flow ▪ NSV flow alternative ▪ External pressure ▪ Exciter current 1 ▪ Exciter current 2 ▪ Oscillation frequency 1 ▪ Oscillation frequency 2 ▪ S&W volume flow ▪ Reference density
		<ul style="list-style-type: none"> ▪ Reference density alternative ▪ Corrected volume flow ▪ Oil corrected volume flow ▪ Water corrected volume flow ▪ Oscillation damping fluctuation 1 ▪ Oscillation damping fluctuation 2 ▪ Frequency fluctuation 1 ▪ Frequency fluctuation 2 ▪ Target mass flow ▪ Carrier volume flow ▪ Target volume flow ▪ Temp. compensated dynamic viscosity ▪ Temp. compensated kinematic viscosity ▪ Temperature ▪ Status ▪ Volume flow ▪ Oil volume flow ▪ Water volume flow ▪ Water cut

1) Diagnostic behavior can be changed. This causes the overall status of the measured variable to change.

Diagnostic information		Remedy instructions
No.	Short text	
833	Electronic temperature too low	Increase ambient temperature
Measured variable status [from the factory] ¹⁾		
Quality	Good	
Quality substatus	Ok	
Coding (hex)	0x80 to 0x83	
Status signal	S	
Diagnostic behavior	Warning	
Influenced measured variables		
<ul style="list-style-type: none"> ▪ Oscillation amplitude 1 ▪ Oscillation amplitude 2 ▪ Application specific output ▪ Application specific output ▪ Signal asymmetry ▪ Carrier mass flow ▪ Carrier pipe temperature ▪ Target corrected volume flow ▪ Carrier corrected volume flow ▪ Concentration ▪ Measured values 1 ▪ Measured values 2 ▪ Measured values 3 ▪ Oscillation damping 1 ▪ Oscillation damping 2 ▪ Density ▪ Oil density ▪ Water density ▪ Dynamic viscosity 		<ul style="list-style-type: none"> ▪ Sensor electronic temperature (ISEM) ▪ GSV flow ▪ GSV flow alternative ▪ Kinematic viscosity ▪ Mass flow ▪ Oil mass flow ▪ Water mass flow ▪ Index inhomogeneous medium ▪ Index suspended bubbles ▪ HBSI ▪ NSV flow ▪ NSV flow alternative ▪ External pressure ▪ Exciter current 1 ▪ Exciter current 2 ▪ Oscillation frequency 1 ▪ Oscillation frequency 2 ▪ S&W volume flow ▪ Reference density
		<ul style="list-style-type: none"> ▪ Reference density alternative ▪ Corrected volume flow ▪ Oil corrected volume flow ▪ Water corrected volume flow ▪ Oscillation damping fluctuation 1 ▪ Oscillation damping fluctuation 2 ▪ Frequency fluctuation 1 ▪ Frequency fluctuation 2 ▪ Target mass flow ▪ Carrier volume flow ▪ Target volume flow ▪ Temp. compensated dynamic viscosity ▪ Temp. compensated kinematic viscosity ▪ Temperature ▪ Status ▪ Volume flow ▪ Oil volume flow ▪ Water volume flow ▪ Water cut

1) Diagnostic behavior can be changed. This causes the overall status of the measured variable to change.

Diagnostic information		Remedy instructions	
No.	Short text		
834	Process temperature too high	Reduce process temperature	
	Measured variable status [from the factory] ¹⁾		
	Quality		Good
	Quality substatus		Ok
	Coding (hex)		0x80 to 0x83
	Status signal		S
	Diagnostic behavior		Warning
Influenced measured variables			
<ul style="list-style-type: none"> ▪ Oscillation amplitude 1 ▪ Oscillation amplitude 2 ▪ Application specific output ▪ Application specific output ▪ Signal asymmetry ▪ Carrier mass flow ▪ Carrier pipe temperature ▪ Target corrected volume flow ▪ Carrier corrected volume flow ▪ Concentration ▪ Oscillation damping 1 ▪ Oscillation damping 2 ▪ Density ▪ Oil density ▪ Water density ▪ Dynamic viscosity ▪ Sensor electronic temperature (ISEM) ▪ GSV flow ▪ GSV flow alternative ▪ Kinematic viscosity ▪ Mass flow ▪ Oil mass flow ▪ Water mass flow ▪ Index inhomogeneous medium ▪ Index suspended bubbles ▪ HBSI ▪ NSV flow ▪ NSV flow alternative ▪ External pressure ▪ Exciter current 1 ▪ Exciter current 2 ▪ Oscillation frequency 1 ▪ Oscillation frequency 2 ▪ S&W volume flow ▪ Reference density ▪ Reference density alternative ▪ Corrected volume flow ▪ Oil corrected volume flow ▪ Water corrected volume flow ▪ Oscillation damping fluctuation 1 ▪ Oscillation damping fluctuation 2 ▪ Frequency fluctuation 1 ▪ Frequency fluctuation 2 ▪ Target mass flow ▪ Carrier volume flow ▪ Target volume flow ▪ Temp. compensated dynamic viscosity ▪ Temp. compensated kinematic viscosity ▪ Temperature ▪ Status ▪ Volume flow ▪ Oil volume flow ▪ Water volume flow ▪ Water cut 			

1) Diagnostic behavior can be changed. This causes the overall status of the measured variable to change.

Diagnostic information		Remedy instructions
No.	Short text	
835	Process temperature too low	Increase process temperature
	Measured variable status [from the factory] ¹⁾	
	Quality	Good
	Quality substatus	Ok
	Coding (hex)	0x80 to 0x83
	Status signal	S
	Diagnostic behavior	Warning
	Influenced measured variables	
	<ul style="list-style-type: none"> ▪ Oscillation amplitude 1 ▪ Oscillation amplitude 2 ▪ Application specific output ▪ Application specific output ▪ Signal asymmetry ▪ Carrier mass flow ▪ Carrier pipe temperature ▪ Target corrected volume flow ▪ Carrier corrected volume flow ▪ Concentration ▪ Oscillation damping 1 ▪ Oscillation damping 2 ▪ Density ▪ Oil density ▪ Water density ▪ Dynamic viscosity ▪ Sensor electronic temperature (ISEM) ▪ GSV flow 	<ul style="list-style-type: none"> ▪ GSV flow alternative ▪ Kinematic viscosity ▪ Mass flow ▪ Oil mass flow ▪ Water mass flow ▪ Index inhomogeneous medium ▪ Index suspended bubbles ▪ HBSI ▪ NSV flow ▪ NSV flow alternative ▪ External pressure ▪ Exciter current 1 ▪ Exciter current 2 ▪ Oscillation frequency 1 ▪ Oscillation frequency 2 ▪ S&W volume flow ▪ Reference density ▪ Reference density alternative
		<ul style="list-style-type: none"> ▪ Corrected volume flow ▪ Oil corrected volume flow ▪ Water corrected volume flow ▪ Oscillation damping fluctuation 1 ▪ Oscillation damping fluctuation 2 ▪ Frequency fluctuation 1 ▪ Frequency fluctuation 2 ▪ Target mass flow ▪ Carrier volume flow ▪ Target volume flow ▪ Temp. compensated dynamic viscosity ▪ Temp. compensated kinematic viscosity ▪ Temperature ▪ Status ▪ Volume flow ▪ Oil volume flow ▪ Water volume flow ▪ Water cut

1) Diagnostic behavior can be changed. This causes the overall status of the measured variable to change.

Diagnostic information		Remedy instructions	
No.	Short text		
842	Process limit	Low flow cut off active! 1. Check low flow cut off configuration	
	Measured variable status [from the factory] ¹⁾		
	Quality		Good
	Quality substatus		Ok
	Coding (hex)		0x80 to 0x83
	Status signal		S
	Diagnostic behavior		Warning
Influenced measured variables			
<ul style="list-style-type: none"> ▪ Oscillation amplitude 1 ▪ Oscillation amplitude 2 ▪ Application specific output ▪ Application specific output ▪ Signal asymmetry ▪ Carrier mass flow ▪ Carrier pipe temperature ▪ Target corrected volume flow ▪ Carrier corrected volume flow ▪ Concentration ▪ Oscillation damping 1 ▪ Oscillation damping 2 ▪ Density ▪ Oil density ▪ Water density ▪ Dynamic viscosity ▪ Sensor electronic temperature (ISEM) ▪ GSV flow ▪ GSV flow alternative ▪ Kinematic viscosity ▪ Mass flow ▪ Oil mass flow ▪ Water mass flow ▪ Index inhomogeneous medium ▪ Index suspended bubbles ▪ HBSI ▪ NSV flow ▪ NSV flow alternative ▪ External pressure ▪ Exciter current 1 ▪ Exciter current 2 ▪ Oscillation frequency 1 ▪ Oscillation frequency 2 ▪ S&W volume flow ▪ Reference density ▪ Reference density alternative ▪ Corrected volume flow ▪ Oil corrected volume flow ▪ Water corrected volume flow ▪ Oscillation damping fluctuation 1 ▪ Oscillation damping fluctuation 2 ▪ Frequency fluctuation 1 ▪ Frequency fluctuation 2 ▪ Target mass flow ▪ Carrier volume flow ▪ Target volume flow ▪ Temp. compensated dynamic viscosity ▪ Temp. compensated kinematic viscosity ▪ Temperature ▪ Status ▪ Volume flow ▪ Oil volume flow ▪ Water volume flow ▪ Water cut 			

1) Diagnostic behavior can be changed. This causes the overall status of the measured variable to change.

Diagnostic information		Remedy instructions	
No.	Short text		
862	Partly filled pipe	1. Check for gas in process 2. Adjust detection limits	
	Measured variable status [from the factory] ¹⁾		
	Quality		Good
	Quality substatus		Ok
	Coding (hex)		0x80 to 0x83
	Status signal		S
	Diagnostic behavior		Warning
Influenced measured variables			
<ul style="list-style-type: none"> ▪ Application specific output ▪ Application specific output ▪ Carrier mass flow ▪ Target corrected volume flow ▪ Carrier corrected volume flow ▪ Concentration ▪ Density ▪ Oil density ▪ Water density ▪ Dynamic viscosity ▪ GSV flow ▪ GSV flow alternative ▪ Kinematic viscosity ▪ Mass flow ▪ Oil mass flow ▪ Water mass flow ▪ Index inhomogeneous medium ▪ Index suspended bubbles ▪ HBSI ▪ NSV flow ▪ NSV flow alternative ▪ External pressure ▪ S&W volume flow ▪ Reference density ▪ Reference density alternative ▪ Corrected volume flow ▪ Oil corrected volume flow ▪ Water corrected volume flow ▪ Target mass flow ▪ Carrier volume flow ▪ Target volume flow ▪ Temp. compensated dynamic viscosity ▪ Temp. compensated kinematic viscosity ▪ Temperature ▪ Status ▪ Volume flow ▪ Oil volume flow ▪ Water volume flow ▪ Water cut 			

1) Diagnostic behavior can be changed. This causes the overall status of the measured variable to change.

Diagnostic information		Remedy instructions
No.	Short text	
882	Input signal	1. Check input configuration 2. Check external device or process conditions
	Measured variable status	
	Quality	Bad
	Quality substatus	Maintenance alarm
	Coding (hex)	0x24 to 0x27
	Status signal	F
	Diagnostic behavior	Alarm
	Influenced measured variables	
	<ul style="list-style-type: none"> ▪ Oscillation amplitude 1 ▪ Oscillation amplitude 2 ▪ Application specific output ▪ Application specific output ▪ Signal asymmetry ▪ Carrier mass flow ▪ Carrier pipe temperature ▪ Target corrected volume flow ▪ Carrier corrected volume flow ▪ Concentration ▪ Measured values 1 ▪ Measured values 2 ▪ Measured values 3 ▪ Oscillation damping 1 ▪ Oscillation damping 2 ▪ Density ▪ Oil density ▪ Water density ▪ Dynamic viscosity 	<ul style="list-style-type: none"> ▪ Sensor electronic temperature (ISEM) ▪ GSV flow ▪ GSV flow alternative ▪ Kinematic viscosity ▪ Mass flow ▪ Oil mass flow ▪ Water mass flow ▪ Index inhomogeneous medium ▪ Index suspended bubbles ▪ HBSI ▪ NSV flow ▪ NSV flow alternative ▪ External pressure ▪ Exciter current 1 ▪ Exciter current 2 ▪ Oscillation frequency 1 ▪ Oscillation frequency 2 ▪ S&W volume flow ▪ Reference density
		<ul style="list-style-type: none"> ▪ Reference density alternative ▪ Corrected volume flow ▪ Oil corrected volume flow ▪ Water corrected volume flow ▪ Oscillation damping fluctuation 1 ▪ Oscillation damping fluctuation 2 ▪ Frequency fluctuation 1 ▪ Frequency fluctuation 2 ▪ Target mass flow ▪ Carrier volume flow ▪ Target volume flow ▪ Temp. compensated dynamic viscosity ▪ Temp. compensated kinematic viscosity ▪ Temperature ▪ Status ▪ Volume flow ▪ Oil volume flow ▪ Water volume flow ▪ Water cut

Diagnostic information		Remedy instructions	
No.	Short text		
910	Tubes not oscillating	1. Check electronic 2. Inspect sensor	
	Measured variable status		
	Quality		Bad
	Quality substatus		Maintenance alarm
	Coding (hex)		0x24 to 0x27
	Status signal		F
	Diagnostic behavior		Alarm
Influenced measured variables			
<ul style="list-style-type: none"> ▪ Oscillation amplitude 1 ▪ Oscillation amplitude 2 ▪ Application specific output ▪ Application specific output ▪ Signal asymmetry ▪ Carrier mass flow ▪ Carrier pipe temperature ▪ Target corrected volume flow ▪ Carrier corrected volume flow ▪ Concentration ▪ Oscillation damping 1 ▪ Oscillation damping 2 ▪ Density ▪ Oil density ▪ Water density ▪ Dynamic viscosity ▪ Sensor electronic temperature (ISEM) ▪ GSV flow ▪ GSV flow alternative ▪ Kinematic viscosity ▪ Mass flow ▪ Oil mass flow ▪ Water mass flow ▪ Index inhomogeneous medium ▪ Index suspended bubbles ▪ HBSI ▪ NSV flow ▪ NSV flow alternative ▪ External pressure ▪ Exciter current 1 ▪ Exciter current 2 ▪ Oscillation frequency 1 ▪ Oscillation frequency 2 ▪ S&W volume flow ▪ Reference density ▪ Reference density alternative ▪ Corrected volume flow ▪ Oil corrected volume flow ▪ Water corrected volume flow ▪ Oscillation damping fluctuation 1 ▪ Oscillation damping fluctuation 2 ▪ Frequency fluctuation 1 ▪ Frequency fluctuation 2 ▪ Target mass flow ▪ Carrier volume flow ▪ Target volume flow ▪ Temp. compensated dynamic viscosity ▪ Temp. compensated kinematic viscosity ▪ Temperature ▪ Status ▪ Volume flow ▪ Oil volume flow ▪ Water volume flow ▪ Water cut 			

Diagnostic information		Remedy instructions	
No.	Short text		
912	Medium inhomogeneous	1. Check process cond. 2. Increase system pressure	
	Measured variable status [from the factory] ¹⁾		
	Quality		Good
	Quality substatus		Ok
	Coding (hex)		0x80 to 0x83
	Status signal		S
	Diagnostic behavior		Warning
Influenced measured variables			
<ul style="list-style-type: none"> ▪ Oscillation amplitude 1 ▪ Oscillation amplitude 2 ▪ Application specific output ▪ Application specific output ▪ Signal asymmetry ▪ Carrier mass flow ▪ Carrier pipe temperature ▪ Target corrected volume flow ▪ Carrier corrected volume flow ▪ Concentration ▪ Oscillation damping 1 ▪ Oscillation damping 2 ▪ Density ▪ Oil density ▪ Water density ▪ Dynamic viscosity ▪ Sensor electronic temperature (ISEM) ▪ GSV flow ▪ GSV flow alternative ▪ Kinematic viscosity ▪ Mass flow ▪ Oil mass flow ▪ Water mass flow ▪ Index inhomogeneous medium ▪ Index suspended bubbles ▪ HBSI ▪ NSV flow ▪ NSV flow alternative ▪ External pressure ▪ Exciter current 1 ▪ Exciter current 2 ▪ Oscillation frequency 1 ▪ Oscillation frequency 2 ▪ S&W volume flow ▪ Reference density ▪ Reference density alternative ▪ Corrected volume flow ▪ Oil corrected volume flow ▪ Water corrected volume flow ▪ Oscillation damping fluctuation 1 ▪ Oscillation damping fluctuation 2 ▪ Frequency fluctuation 1 ▪ Frequency fluctuation 2 ▪ Target mass flow ▪ Carrier volume flow ▪ Target volume flow ▪ Temp. compensated dynamic viscosity ▪ Temp. compensated kinematic viscosity ▪ Temperature ▪ Status ▪ Volume flow ▪ Oil volume flow ▪ Water volume flow ▪ Water cut 			

1) Diagnostic behavior can be changed. This causes the overall status of the measured variable to change.

Diagnostic information		Remedy instructions	
No.	Short text		
913	Medium unsuitable	1. Check process conditions 2. Check electronic modules or sensor	
	Measured variable status [from the factory] ¹⁾		
	Quality		Good
	Quality substatus		Ok
	Coding (hex)		0x80 to 0x83
	Status signal		S
	Diagnostic behavior		Warning
	Influenced measured variables		
<ul style="list-style-type: none"> ▪ Oscillation amplitude 1 ▪ Oscillation amplitude 2 ▪ Application specific output ▪ Application specific output ▪ Signal asymmetry ▪ Carrier mass flow ▪ Carrier pipe temperature ▪ Target corrected volume flow ▪ Carrier corrected volume flow ▪ Concentration ▪ Oscillation damping 1 ▪ Oscillation damping 2 ▪ Density ▪ Oil density ▪ Water density ▪ Dynamic viscosity ▪ Sensor electronic temperature (ISEM) ▪ GSV flow ▪ GSV flow alternative ▪ Kinematic viscosity ▪ Mass flow ▪ Oil mass flow ▪ Water mass flow ▪ Index inhomogeneous medium ▪ Index suspended bubbles ▪ HBSI ▪ NSV flow ▪ NSV flow alternative ▪ External pressure ▪ Exciter current 1 ▪ Exciter current 2 ▪ Oscillation frequency 1 ▪ Oscillation frequency 2 ▪ S&W volume flow ▪ Reference density ▪ Reference density alternative ▪ Corrected volume flow ▪ Oil corrected volume flow ▪ Water corrected volume flow ▪ Oscillation damping fluctuation 1 ▪ Oscillation damping fluctuation 2 ▪ Frequency fluctuation 1 ▪ Frequency fluctuation 2 ▪ Target mass flow ▪ Carrier volume flow ▪ Target volume flow ▪ Temp. compensated dynamic viscosity ▪ Temp. compensated kinematic viscosity ▪ Temperature ▪ Status ▪ Volume flow ▪ Oil volume flow ▪ Water volume flow ▪ Water cut 			

1) Diagnostic behavior can be changed. This causes the overall status of the measured variable to change.

Diagnostic information		Remedy instructions	
No.	Short text		
941	API temperature out of specification	1. Check process temperature with selected API commodity group 2. Check API related parameters	
	Measured variable status [from the factory] ¹⁾		
	Quality		Bad
	Quality substatus		Maintenance alarm
	Coding (hex)		0x24 to 0x27
	Status signal		S
	Diagnostic behavior		Warning
	Influenced measured variables		
<ul style="list-style-type: none"> ▪ Oil density ▪ Water density ▪ GSV flow ▪ GSV flow alternative ▪ Mass flow ▪ Oil mass flow ▪ Water mass flow ▪ NSV flow ▪ NSV flow alternative ▪ External pressure ▪ S&W volume flow ▪ Reference density alternative ▪ Corrected volume flow ▪ Oil corrected volume flow ▪ Water corrected volume flow ▪ Oil volume flow ▪ Water volume flow ▪ Water cut 			

1) Diagnostic behavior can be changed. This causes the overall status of the measured variable to change.

Diagnostic information		Remedy instructions	
No.	Short text		
942	API density out of specification	1. Check process density with selected API commodity group 2. Check API related parameters	
	Measured variable status [from the factory] ¹⁾		
	Quality		Bad
	Quality substatus		Maintenance alarm
	Coding (hex)		0x24 to 0x27
	Status signal		S
	Diagnostic behavior		Warning
	Influenced measured variables		
Mass flow			

1) Diagnostic behavior can be changed. This causes the overall status of the measured variable to change.

Diagnostic information		Remedy instructions	
No.	Short text		
943	API pressure out of specification	1. Check process pressure with selected API commodity group 2. Check API related parameters	
	Measured variable status [from the factory] ¹⁾		
	Quality		Bad
	Quality substatus		Maintenance alarm
	Coding (hex)		0x24 to 0x27
	Status signal		S
	Diagnostic behavior		Warning
	Influenced measured variables		
<ul style="list-style-type: none"> ■ Oil density ■ Water density ■ GSV flow ■ GSV flow alternative ■ Mass flow ■ Oil mass flow ■ Water mass flow ■ NSV flow ■ NSV flow alternative ■ External pressure ■ S&W volume flow ■ Reference density alternative ■ Corrected volume flow ■ Oil corrected volume flow ■ Water corrected volume flow ■ Oil volume flow ■ Water volume flow ■ Water cut 			

1) Diagnostic behavior can be changed. This causes the overall status of the measured variable to change.

Diagnostic information		Remedy instructions	
No.	Short text		
944	Monitoring failed	Check process conditions for Heartbeat Monitoring	
	Measured variable status [from the factory] ¹⁾		
	Quality		Good
	Quality substatus		Ok
	Coding (hex)		0x80 to 0x83
	Status signal		S
	Diagnostic behavior		Warning
Influenced measured variables			
<ul style="list-style-type: none"> ▪ Oscillation amplitude 1 ▪ Oscillation amplitude 2 ▪ Application specific output ▪ Application specific output ▪ Signal asymmetry ▪ Carrier mass flow ▪ Carrier pipe temperature ▪ Concentration ▪ Oscillation damping 1 ▪ Oscillation damping 2 ▪ Density ▪ Dynamic viscosity 		<ul style="list-style-type: none"> ▪ Sensor electronic temperature (ISEM) ▪ Kinematic viscosity ▪ Mass flow ▪ Index inhomogeneous medium ▪ Index suspended bubbles ▪ HBSI ▪ External pressure ▪ Exciter current 1 ▪ Exciter current 2 ▪ Oscillation frequency 1 ▪ Oscillation frequency 2 ▪ Reference density 	
		<ul style="list-style-type: none"> ▪ Corrected volume flow ▪ Oscillation damping fluctuation 1 ▪ Oscillation damping fluctuation 2 ▪ Frequency fluctuation 1 ▪ Frequency fluctuation 2 ▪ Target mass flow ▪ Temp. compensated dynamic viscosity ▪ Temp. compensated kinematic viscosity ▪ Temperature ▪ Status ▪ Volume flow 	

1) Diagnostic behavior can be changed. This causes the overall status of the measured variable to change.





Diagnostic information		Remedy instructions	
No.	Short text		
948	Oscillation damping too high	Check process conditions	
	Measured variable status [from the factory] ¹⁾		
	Quality		Good
	Quality substatus		Ok
	Coding (hex)		0x80 to 0x83
	Status signal		S
	Diagnostic behavior		Warning
Influenced measured variables			
<ul style="list-style-type: none"> ▪ Oscillation amplitude 1 ▪ Oscillation amplitude 2 ▪ Application specific output ▪ Application specific output ▪ Signal asymmetry ▪ Carrier mass flow ▪ Carrier pipe temperature ▪ Target corrected volume flow ▪ Carrier corrected volume flow ▪ Concentration ▪ Oscillation damping 1 ▪ Oscillation damping 2 ▪ Density ▪ Oil density ▪ Water density ▪ Dynamic viscosity ▪ Sensor electronic temperature (ISEM) ▪ GSV flow 		<ul style="list-style-type: none"> ▪ GSV flow alternative ▪ Kinematic viscosity ▪ Mass flow ▪ Oil mass flow ▪ Water mass flow ▪ Index inhomogeneous medium ▪ Index suspended bubbles ▪ HBSI ▪ NSV flow ▪ NSV flow alternative ▪ External pressure ▪ Exciter current 1 ▪ Exciter current 2 ▪ Oscillation frequency 1 ▪ Oscillation frequency 2 ▪ S&W volume flow ▪ Reference density ▪ Reference density alternative 	
		<ul style="list-style-type: none"> ▪ Corrected volume flow ▪ Oil corrected volume flow ▪ Water corrected volume flow ▪ Oscillation damping fluctuation 1 ▪ Oscillation damping fluctuation 2 ▪ Frequency fluctuation 1 ▪ Frequency fluctuation 2 ▪ Target mass flow ▪ Carrier volume flow ▪ Target volume flow ▪ Temp. compensated dynamic viscosity ▪ Temp. compensated kinematic viscosity ▪ Temperature ▪ Status ▪ Volume flow ▪ Oil volume flow ▪ Water volume flow ▪ Water cut 	



1) Diagnostic behavior can be changed. This causes the overall status of the measured variable to change.

12.8 Pending diagnostic events

The **Diagnostics** menu allows the user to view the current diagnostic event and the previous diagnostic event separately.





 To call up the measures to rectify a diagnostic event:

- Via local display →  161
- Via web browser →  162
- Via "FieldCare" operating tool →  163
- Via "DeviceCare" operating tool →  163

 Other pending diagnostic events can be displayed in the **Diagnostic list** submenu →  218.

Navigation

"Diagnostics" menu

 Diagnostics	
Actual diagnostics	→  218
Previous diagnostics	→  218
Operating time from restart	→  218
Operating time	→  218

Parameter overview with brief description

Parameter	Prerequisite	Description	User interface
Actual diagnostics	A diagnostic event has occurred.	Shows the current occurred diagnostic event along with its diagnostic information.  If two or more messages occur simultaneously, the message with the highest priority is shown on the display.	Symbol for diagnostic behavior, diagnostic code and short message.
Previous diagnostics	Two diagnostic events have already occurred.	Shows the diagnostic event that occurred prior to the current diagnostic event along with its diagnostic information.	Symbol for diagnostic behavior, diagnostic code and short message.
Operating time from restart	–	Shows the time the device has been in operation since the last device restart.	Days (d), hours (h), minutes (m) and seconds (s)
Operating time	–	Indicates how long the device has been in operation.	Days (d), hours (h), minutes (m) and seconds (s)

12.9 Diagnostics list

Up to 5 currently pending diagnostic events can be displayed in the **Diagnostic list** submenu along with the associated diagnostic information. If more than 5 diagnostic events are pending, the events with the highest priority are shown on the display.

Navigation path

Diagnostics → Diagnostic list

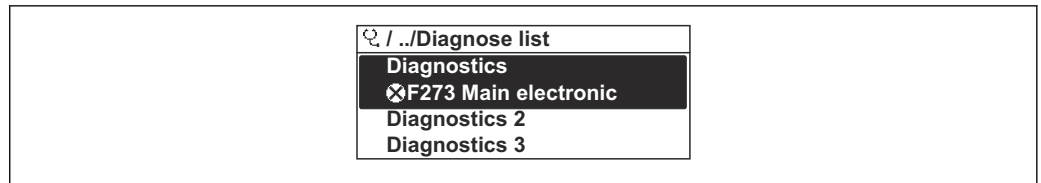

A0014006-EN

33 Using the example of the local display

- i** To call up the measures to rectify a diagnostic event:
- Via local display → 161
 - Via web browser → 162
 - Via "FieldCare" operating tool → 163
 - Via "DeviceCare" operating tool → 163

12.10 Event logbook

12.10.1 Reading out the event logbook

A chronological overview of the event messages that have occurred is provided in the **Events list** submenu.

Navigation path

Diagnostics menu → **Event logbook** submenu → Events list

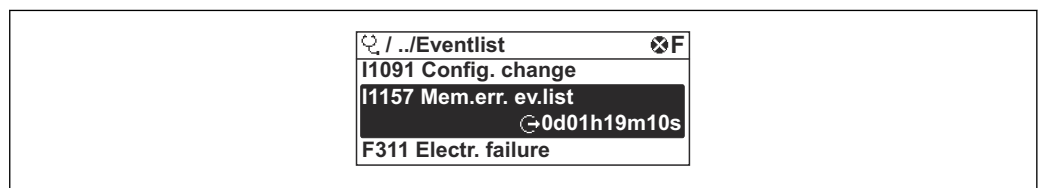

A0014008-EN

34 Using the example of the local display

- A maximum of 20 event messages can be displayed in chronological order.
- If the **Extended HistoROM** application package (order option) is enabled in the device, the event list can contain up to 100 entries.

The event history includes entries for:

- Diagnostic events → 167
- Information events → 220

In addition to the operating time when the event occurred, each event is also assigned a symbol that indicates whether the event has occurred or is finished:

- Diagnostics event
 - ⌚: Occurrence of the event
 - ⌚: End of the event
- Information event
 - ⌚: Occurrence of the event

- i** To call up the measures to rectify a diagnostic event:
- Via local display → 161
 - Via web browser → 162
 - Via "FieldCare" operating tool → 163
 - Via "DeviceCare" operating tool → 163

- i** For filtering the displayed event messages → 220

12.10.2 Filtering the event logbook

Using the **Filter options** parameter you can define which category of event message is displayed in the **Events list** submenu.

Navigation path

Diagnostics → Event logbook → Filter options

Filter categories

- All
- Failure (F)
- Function check (C)
- Out of specification (S)
- Maintenance required (M)
- Information (I)

12.10.3 Overview of information events

Unlike a diagnostic event, an information event is displayed in the event logbook only and not in the diagnostic list.

Info number	Info name
I1000	----- (Device ok)
I1079	Sensor changed
I1089	Power on
I1090	Configuration reset
I1091	Configuration changed
I1092	HistoROM backup deleted
I1111	Density adjust failure
I1137	Electronic changed
I1151	History reset
I1155	Reset electronic temperature
I1156	Memory error trend
I1157	Memory error event list
I1209	Density adjustment ok
I1221	Zero point adjust failure
I1222	Zero point adjustment ok
I1256	Display: access status changed
I1278	I/O module restarted
I1335	Firmware changed
I1361	Web server: login failed
I1397	Fieldbus: access status changed
I1398	CDI: access status changed
I1444	Device verification passed
I1445	Device verification failed
I1447	Record application reference data
I1448	Application reference data recorded
I1449	Recording application ref. data failed
I1450	Monitoring off
I1451	Monitoring on

Info number	Info name
I1457	Measurement error verification failed
I1459	I/O module verification failed
I1460	HBSI verification failed
I1461	Sensor verification failed
I1462	Sensor electronic module verific. failed
I1512	Download started
I1513	Download finished
I1514	Upload started
I1515	Upload finished
I1618	I/O module 2 replaced
I1619	I/O module 3 replaced
I1621	I/O module 4 replaced
I1622	Calibration changed
I1624	Reset all totalizers
I1625	Write protection activated
I1626	Write protection deactivated
I1627	Web server: login successful
I1628	Display: login successful
I1629	CDI: login successful
I1631	Web server access changed
I1632	Display: login failed
I1633	CDI: login failed
I1634	Reset to factory settings
I1635	Reset to delivery settings
I1639	Max. switch cycles number reached
I1649	Hardware write protection activated
I1650	Hardware write protection deactivated
I1712	New flash file received
I1725	Sensor electronic module (ISEM) changed
I1726	Configuration backup failed

12.11 Resetting the measuring device

The entire device configuration or some of the configuration can be reset to a defined state with the **Device reset** parameter (→  136).

12.11.1 Function range of "Device reset" parameter

Options	Description
Cancel	No action is executed and the user exits the parameter.
To delivery settings	Every parameter for which a customer-specific default setting was ordered is reset to the customer-specific value. All other parameters are reset to the factory setting.









Options	Description
Restart device	The restart resets every parameter with data stored in volatile memory (RAM) to the factory setting (e.g. measured value data). The device configuration remains unchanged.
Restore S-DAT backup	Restores the data that is saved on the S-DAT. Additional information: This function can be used to resolve the memory issue "083 Memory content inconsistent" or to restore the S-DAT data when a new S-DAT has been installed.  This option is displayed only in an alarm condition.

12.12 Device information

The **Device information** submenu contains all parameters that display different information for device identification.





Navigation

"Diagnostics" menu → Device information

► Device information	
Device tag	→  222
Serial number	→  222
Firmware version	→  222
Device name	→  223
Manufacturer	
Order code	→  223
Extended order code 1	→  223
Extended order code 2	→  223
Extended order code 3	→  223
ENP version	→  223



Parameter overview with brief description

Parameter	Description	User interface	Factory setting
Device tag	Shows name of measuring point.	Max. 32 characters such as lower-case letters or numbers.	–
Serial number	Shows the serial number of the measuring device.	Max. 11-digit character string comprising letters and numbers.	–
Firmware version	Shows the device firmware version installed.	Character string in the format xx.yy.zz	–

Parameter	Description	User interface	Factory setting
Device name	Shows the name of the transmitter.  The name can be found on the nameplate of the transmitter.	Promass 300/500	–
Device name		Max. 32 characters such as lower-case letters or numbers.	eh-promass100-xxxxx
Order code	Shows the device order code.  The order code can be found on the nameplate of the sensor and transmitter in the "Order code" field.	Character string composed of letters, numbers and certain punctuation marks (e.g. /).	–
Extended order code 1	Shows the 1st part of the extended order code.  The extended order code can also be found on the nameplate of the sensor and transmitter in the "Ext. ord. cd." field.	Character string	–
Extended order code 2	Shows the 2nd part of the extended order code.  The extended order code can also be found on the nameplate of the sensor and transmitter in the "Ext. ord. cd." field.	Character string	–
Extended order code 3	Shows the 3rd part of the extended order code.  The extended order code can also be found on the nameplate of the sensor and transmitter in the "Ext. ord. cd." field.	Character string	–
ENP version	Shows the version of the electronic nameplate (ENP).	Character string	–

12.13 Firmware history

Release date	Firmware version	Order code for "Firmware version"	Firmware Changes	Documentation type	Documentation
2022	01.01.zz	Option 67	Original firmware	Operating Instructions	BA02108D/06/EN/01.21

-  It is possible to flash the firmware to the current version using the service interface.
-  For the compatibility of the firmware version with the installed device description files and operating tools, observe the information about the device in the "Manufacturer's information" document.
-  The manufacturer's information is available:
 - In the Download Area of the Endress+Hauser web site: www.endress.com → Downloads
 - Specify the following details:
 - Product root: e.g. 8A3B
The product root is the first part of the order code: see the nameplate on the device.
 - Text search: Manufacturer's information
 - Media type: Documentation – Technical Documentation

13 Maintenance

13.1 Maintenance work

No special maintenance work is required.

13.1.1 Exterior cleaning

When cleaning the exterior of measuring devices, always use cleaning agents that do not attack the surface of the housing or the seals.

13.1.2 Internal cleaning

Observe the following points for CIP and SIP cleaning:

- Use only cleaning agents to which the process-wetted materials are adequately resistant.
- Observe the maximum permitted medium temperature for the measuring device .

13.2 Measuring and test equipment

Endress+Hauser offers a variety of measuring and testing equipment, such as Netilion or device tests.

 Your Endress+Hauser Sales Center can provide detailed information on the services.

List of some of the measuring and testing equipment: →  229

13.3 Endress+Hauser services

Endress+Hauser offers a wide variety of services for maintenance such as recalibration, maintenance service or device tests.

 Your Endress+Hauser Sales Center can provide detailed information on the services.

14 Repair

14.1 General notes

14.1.1 Repair and conversion concept

The Endress+Hauser repair and conversion concept provides for the following:

- The measuring devices have a modular design.
- Spare parts are grouped into logical kits with the associated Installation Instructions.
- Repairs are carried out by Endress+Hauser Service or by appropriately trained customers.
- Certified devices can only be converted to other certified devices by Endress+Hauser Service or at the factory.

14.1.2 Notes for repair and conversion

For repair and conversion of a measuring device, observe the following notes:

- ▶ Use only original Endress+Hauser spare parts.
- ▶ Carry out the repair according to the Installation Instructions.
- ▶ Observe the applicable standards, federal/national regulations, Ex documentation (XA) and certificates.
- ▶ Document all repairs and conversions and enter the details in Netilion Analytics.

14.2 Spare parts

Device Viewer (www.endress.com/deviceviewer):

All the spare parts for the measuring device, along with the order code, are listed here and can be ordered. If available, users can also download the associated Installation Instructions.



Measuring device serial number:

- Is located on the nameplate of the device.
- Can be read out via the **Serial number** parameter (→ 222) in the **Device information** submenu.

14.3 Endress+Hauser services

Endress+Hauser offers a wide range of services.



Your Endress+Hauser Sales Center can provide detailed information on the services.

14.4 Return

The requirements for safe device return can vary depending on the device type and national legislation.

1. Refer to the web page for information:
<https://www.endress.com/support/return-material>
↳ Select the region.
2. If returning the device, pack the device in such a way that it is reliably protected against impact and external influences. The original packaging offers the best protection.

14.5 Disposal

 If required by the Directive 2012/19/EU on waste electrical and electronic equipment (WEEE), the product is marked with the depicted symbol in order to minimize the disposal of WEEE as unsorted municipal waste. Do not dispose of products bearing this marking as unsorted municipal waste. Instead, return them to the manufacturer for disposal under the applicable conditions.

14.5.1 Removing the measuring device

1. Switch off the device.

WARNING

Danger to persons from process conditions!

- ▶ Beware of hazardous process conditions such as pressure in the measuring device, high temperatures or aggressive media.

2. Carry out the mounting and connection steps from the "Mounting the measuring device" and "Connecting the measuring device" sections in reverse order. Observe the safety instructions.

14.5.2 Disposing of the measuring device

WARNING

Danger to personnel and environment from fluids that are hazardous to health.

- ▶ Ensure that the measuring device and all cavities are free of fluid residues that are hazardous to health or the environment, e.g. substances that have permeated into crevices or diffused through plastic.

Observe the following notes during disposal:











- ▶ Observe valid federal/national regulations.
- ▶ Ensure proper separation and reuse of the device components.

15 Accessories



Various accessories, which can be ordered with the device or subsequently from Endress+Hauser, are available for the device. Detailed information on the order code in question is available from your local Endress+Hauser sales center or on the product page of the Endress+Hauser website: www.endress.com.

15.1 Device-specific accessories





15.1.1 For the transmitter

Accessories	Description
Proline 300 transmitter	<p>Transmitter for replacement or storage. Use the order code to define the following specifications:</p> <ul style="list-style-type: none"> ▪ Approvals ▪ Output ▪ Input ▪ Display/operation ▪ Housing ▪ Software <p> Order code: 8X3BXX</p> <p> Installation Instructions EA01200D</p>
Remote display and operating module DKX001	<ul style="list-style-type: none"> ▪ If ordered directly with the measuring device: Order code for "Display; operation", option O "Remote display 4-line, illuminated; 10 m (30 ft) cable; touch control" ▪ If ordered separately: <ul style="list-style-type: none"> ▪ Measuring device: order code for "Display; operation", option M "W/o, prepared for remote display" ▪ DKX001: Via the separate product structure DKX001 ▪ If ordered subsequently: DKX001: Via the separate product structure DKX001 <p>Mounting bracket for DKX001</p> <ul style="list-style-type: none"> ▪ If ordered directly: order code for "Accessory enclosed", option RA "Mounting bracket, pipe 1/2" ▪ If ordered subsequently: order number: 71340960 <p>Connecting cable (replacement cable) Via the separate product structure: DKX002</p> <p> Further information on display and operating module DKX001 →  250.</p> <p> Special Documentation SD01763D</p>
External WLAN antenna	<p>External WLAN antenna with 1.5 m (59.1 in) connecting cable and two angle brackets. Order code for "Accessory enclosed", option P8 "Wireless antenna wide area".</p> <p> <ul style="list-style-type: none"> ▪ The external WLAN antenna is not suitable for use in hygienic applications. ▪ Additional information regarding the WLAN interface →  72. </p> <p> Order number: 71351317</p> <p> Installation Instructions EA01238D</p>
Weather protection cover	<p>Is used to protect the measuring device from the effects of the weather: e.g. rainwater, excess heating from direct sunlight.</p> <p> Order number: 71343505</p> <p> Installation Instructions EA01160D</p>



15.1.2 For the sensor

Accessories	Description
Heating jacket	<p>Is used to stabilize the temperature of the fluids in the sensor. Water, water vapor and other non-corrosive liquids are permitted for use as fluids.</p> <p> If using oil as a heating medium, please consult with Endress+Hauser.</p> <ul style="list-style-type: none"> ▪ If ordered together with the measuring device: Order code for "Accessory enclosed" <ul style="list-style-type: none"> ▪ Option RB "Heating jacket, G 1/2" female thread" ▪ Option RD "Heating jacket, NPT 1/2" female thread" ▪ If ordered subsequently: Use the order code with the product root DK8003. <p> Special Documentation SD02173D</p>
Sensor holder	<p>For wall, tabletop and pipe mounting.</p> <p> Order number: 71392563</p>





15.2 Communication-specific accessories

Accessories	Description
Fieldgate FXA42	<p>Transmission of the measured values of connected 4 to 20 mA analog measuring instruments, as well as digital measuring instruments</p> <p> <ul style="list-style-type: none"> ▪ Technical Information TI01297S ▪ Operating Instructions BA01778S ▪ Product page: www.endress.com/fxa42 </p>
Field Xpert SMT50	<p>The Field Xpert SMT50 tablet PC for device configuration enables mobile plant asset management in the non-hazardous areas. It is suitable for commissioning and maintenance staff to manage field instruments with a digital communication interface and to record progress.</p> <p>This tablet PC is designed as an all-in-one solution with a preinstalled driver library and is an easy-to-use, touch-sensitive tool which can be used to manage field instruments throughout their entire life cycle.</p> <p> <ul style="list-style-type: none"> ▪ Technical Information TI01555S ▪ Operating Instructions BA02053S ▪ Product page: www.endress.com/smt50 </p>
Field Xpert SMT70	<p>The Field Xpert SMT70 tablet PC for device configuration enables mobile plant asset management in hazardous and non-hazardous areas. It is suitable for commissioning and maintenance staff to manage field instruments with a digital communication interface and to record progress.</p> <p>This tablet PC is designed as an all-in-one solution with a preinstalled driver library and is an easy-to-use, touch-sensitive tool which can be used to manage the field instruments throughout their entire life cycle.</p> <p> <ul style="list-style-type: none"> ▪ Technical Information TI01342S ▪ Operating Instructions BA01709S ▪ Product page: www.endress.com/smt70 </p>
Field Xpert SMT77	<p>The Field Xpert SMT77 tablet PC for device configuration enables mobile plant asset management in areas categorized as Ex Zone 1.</p> <p> <ul style="list-style-type: none"> ▪ Technical Information TI01418S ▪ Operating Instructions BA01923S ▪ Product page: www.endress.com/smt77 </p>

15.3 Service-specific accessories

Accessories	Description
Applicator	<p>Software for selecting and sizing Endress+Hauser measuring instruments:</p> <ul style="list-style-type: none"> Choice of measuring instruments for industrial requirements Calculation of all the necessary data for identifying the optimum flowmeter: e.g. nominal diameter, pressure loss, flow velocity and measurement accuracy. Graphic display of the calculation results Determination of the partial order code, administration, documentation and access to all project-related data and parameters over the entire life cycle of a project. <p>Applicator is available: Via the Internet: https://portal.endress.com/webapp/applicator</p>
Netilion	<p>IloT ecosystem: Unlock knowledge With the Netilion IloT ecosystem, Endress+Hauser allows you to optimize your plant performance, digitize workflows, share knowledge, and enhance collaboration.</p> <p>Drawing upon decades of experience in process automation, Endress+Hauser offers the process industry an IloT ecosystem designed to effortlessly extract insights from data. These insights allow process optimization, leading to increased plant availability, efficiency, and reliability - ultimately resulting in a more profitable plant.</p> <p>www.netilion.endress.com</p>
FieldCare	<p>FDT-based plant asset management tool from Endress+Hauser. It can configure all intelligent field units in your system and helps you manage them. By using the status information, it is also a simple but effective way of checking their status and condition.</p> <p> Operating Instructions BA00027S and BA00059S</p>
DeviceCare	<p>Tool to connect and configure Endress+Hauser field devices.</p> <p> Innovation brochure IN01047S</p>

15.4 System components

Accessories	Description
Memograph M graphic data manager	<p>The Memograph M graphic data manager provides information on all the relevant measured variables. Measured values are recorded correctly, limit values are monitored and measuring points analyzed. The data are stored in the 256 MB internal memory and also on a SD card or USB stick.</p> <p> <ul style="list-style-type: none"> Technical Information TI00133R Operating Instructions BA00247R </p>
Cerabar M	<p>The pressure transmitter for measuring the absolute and gauge pressure of gases, steam and liquids. It can be used to read in the operating pressure value.</p> <p> <ul style="list-style-type: none"> Technical Information TI00426P and TI00436P Operating Instructions BA00200P and BA00382P </p>
Cerabar S	<p>The pressure transmitter for measuring the absolute and gauge pressure of gases, steam and liquids. It can be used to read in the operating pressure value.</p> <p> <ul style="list-style-type: none"> Technical Information TI00383P Operating Instructions BA00271P </p>
iTEMP	<p>The temperature transmitters can be used in all applications and are suitable for the measurement of gases, steam and liquids. They can be used to read in the medium temperature.</p> <p> "Fields of Activity" document FA00006T</p>

16 Technical data

16.1 Application

The measuring device is intended only for the flow measurement of liquids and gases.

Depending on the version ordered, the measuring device can also measure potentially explosive, flammable, poisonous and oxidizing media.

To ensure that the device remains in proper operating condition for its service life, use the measuring device only for media against which the process-wetted materials are sufficiently resistant.

16.2 Function and system design

Measuring principle	Mass flow measurement based on the Coriolis measuring principle
Measuring system	<p>The device consists of a transmitter and a sensor.</p> <p>The device is available as a compact version: The transmitter and sensor form a mechanical unit.</p> <p>For information on the structure of the measuring instrument →  14</p>

16.3 Input

Measured variable

Direct measured variables

- Mass flow
- Density
- Temperature

Calculated measured variables

- Volume flow
- Corrected volume flow
- Reference density

Measuring range

Measuring range for liquids

DN		Measuring range full scale values $\dot{m}_{\min(F)}$ to $\dot{m}_{\max(F)}$	
[mm]	[in]	[kg/h]	[lb/min]
1	$\frac{1}{24}$	0 to 20	0 to 0.735
2	$\frac{1}{12}$	0 to 100	0 to 3.675
4	$\frac{1}{6}$	0 to 450	0 to 16.54



Measuring range for gases

The full scale value depends on the density and the sound velocity of the gas used. The full scale value can be calculated with the following formulas:

$$\dot{m}_{\max(G)} = (\rho_G \cdot c_G/m) \cdot d_i^2 \cdot (\pi/4) \cdot 3600 \cdot n$$

$\dot{m}_{\max(G)}$	Maximum full scale value for gas [kg/h]
ρ_G	Gas density in [kg/m ³] at operating conditions
c_G	Sound velocity (gas) [m/s]
d_i	Measuring tube internal diameter [m]
π	Pi
$n = 1$	Number of measuring tubes
$m = 2$	For all gases except pure H ₂ and He gas
$m = 3$	For pure H ₂ and He gas

Recommended measuring range

 Flow limit →  246

Operable flow range

Over 1000 : 1.



Flow rates above the preset full scale value do not override the electronics unit, with the result that the totalizer values are registered correctly.

Input signal

External measured values

To increase the measurement accuracy of certain measured variables or to calculate the corrected volume flow for gases, the automation system can continuously write different measured values to the measuring instrument:

- Operating pressure to increase measurement accuracy (Endress+Hauser recommends the use of a pressure measuring device for absolute pressure, e.g. Cerabar M or Cerabar S)
- Medium temperature to increase measurement accuracy (e.g. iTEMP)
- Reference density for calculating the corrected volume flow for gases

 Various pressure and temperature measuring devices can be ordered from Endress +Hauser: see "Accessories" section →  229

It is recommended to read in external measured values to calculate the corrected volume flow.

Current input

The measured values are written from the automation system to the measuring device via the current input →  232.

Digital communication

The measured values are written by the automation system via PROFINET.

Current input 0/4 to 20 mA

Current input	0/4 to 20 mA (active/passive)
Current span	<ul style="list-style-type: none"> ▪ 4 to 20 mA (active) ▪ 0/4 to 20 mA (passive)
Resolution	1 µA
Voltage drop	Typically: 0.6 to 2 V for 3.6 to 22 mA (passive)
Maximum input voltage	≤ 30 V (passive)
Open-circuit voltage	≤ 28.8 V (active)
Possible input variables	<ul style="list-style-type: none"> ▪ Pressure ▪ Temperature ▪ Density

Status input

Maximum input values	<ul style="list-style-type: none"> ▪ DC -3 to 30 V ▪ If status input is active (ON): $R_i > 3 \text{ k}\Omega$
Response time	Configurable: 5 to 200 ms
Input signal level	<ul style="list-style-type: none"> ▪ Low signal: DC -3 to +5 V ▪ High signal: DC 12 to 30 V
Assignable functions	<ul style="list-style-type: none"> ▪ Off ▪ Reset the individual totalizers separately ▪ Reset all totalizers ▪ Flow override

16.4 Output

Output signal

PROFINET



Standards	In accordance with IEEE 802.3
-----------	-------------------------------

Current output 4 to 20 mA

Signal mode	Can be set to: <ul style="list-style-type: none"> ▪ Active ▪ Passive
Current range	Can be set to: <ul style="list-style-type: none"> ▪ 4 to 20 mA NAMUR ▪ 4 to 20 mA US ▪ 4 to 20 mA ▪ 0 to 20 mA (only if the signal mode is active) ▪ Fixed current
Maximum output values	22.5 mA
Open-circuit voltage	DC 28.8 V (active)
Maximum input voltage	DC 30 V (passive)
Load	0 to 700 Ω
Resolution	0.38 μ A
Damping	Configurable: 0 to 999.9 s
Assignable measured variables	<ul style="list-style-type: none"> ▪ Mass flow ▪ Volume flow ▪ Corrected volume flow ▪ Density ▪ Reference density ▪ Temperature ▪ Electronics temperature ▪ Oscillation frequency 0 ▪ Oscillation damping 0 ▪ Signal asymmetry ▪ Exciter current 0 <p> The range of options increases if the measuring device has one or more application packages.</p>

Pulse/frequency/switch output

Function	Can be configured as pulse, frequency or switch output
Version	Open collector Can be set to: <ul style="list-style-type: none"> ▪ Active ▪ Passive ▪ Passive NAMUR <p> Ex-i, passive</p>
Maximum input values	DC 30 V, 250 mA (passive)
Open-circuit voltage	DC 28.8 V (active)
Voltage drop	For 22.5 mA: \leq DC 2 V
Pulse output	
Maximum input values	DC 30 V, 250 mA (passive)
Maximum output current	22.5 mA (active)

Open-circuit voltage	DC 28.8 V (active)
Pulse width	Configurable: 0.05 to 2 000 ms
Maximum pulse rate	10 000 Impulse/s
Pulse value	Configurable
Assignable measured variables	<ul style="list-style-type: none"> ▪ Mass flow ▪ Volume flow ▪ Corrected volume flow  The range of options increases if the measuring device has one or more application packages.
Frequency output	
Maximum input values	DC 30 V, 250 mA (passive)
Maximum output current	22.5 mA (active)
Open-circuit voltage	DC 28.8 V (active)
Output frequency	Configurable: end value frequency 2 to 10 000 Hz ($f_{max} = 12\,500$ Hz)
Damping	Configurable: 0 to 999.9 s
Pulse/pause ratio	1:1
Assignable measured variables	<ul style="list-style-type: none"> ▪ Mass flow ▪ Volume flow ▪ Corrected volume flow ▪ Density ▪ Reference density ▪ Temperature ▪ Electronics temperature ▪ Oscillation frequency 0 ▪ Oscillation damping 0 ▪ Signal asymmetry ▪ Exciter current 0  The range of options increases if the measuring device has one or more application packages.
Switch output	
Maximum input values	DC 30 V, 250 mA (passive)
Open-circuit voltage	DC 28.8 V (active)
Switching behavior	Binary, conductive or non-conductive
Switching delay	Configurable: 0 to 100 s
Number of switching cycles	Unlimited
Assignable functions	<ul style="list-style-type: none"> ▪ Disable ▪ On ▪ Diagnostic behavior ▪ Limit <ul style="list-style-type: none"> ▪ Mass flow ▪ Volume flow ▪ Corrected volume flow ▪ Density ▪ Reference density ▪ Temperature ▪ Totalizer 1-3 ▪ Flow direction monitoring ▪ Status <ul style="list-style-type: none"> ▪ Partially filled pipe detection ▪ Low flow cut off  The range of options increases if the measuring device has one or more application packages.

Relay output

Function	Switch output
Version	Relay output, galvanically isolated
Switching behavior	Can be set to: <ul style="list-style-type: none"> ▪ NO (normally open), factory setting ▪ NC (normally closed)
Maximum switching capacity (passive)	<ul style="list-style-type: none"> ▪ DC 30 V, 0.1 A ▪ AC 30 V, 0.5 A
Assignable functions	<ul style="list-style-type: none"> ▪ Disable ▪ On ▪ Diagnostic behavior ▪ Limit <ul style="list-style-type: none"> ▪ Mass flow ▪ Volume flow ▪ Corrected volume flow ▪ Density ▪ Reference density ▪ Temperature ▪ Totalizer 1-3 ▪ Flow direction monitoring ▪ Status <ul style="list-style-type: none"> ▪ Partially filled pipe detection ▪ Low flow cut off <p> The range of options increases if the measuring device has one or more application packages.</p>

User-configurable input/output

One specific input or output is assigned to a user-configurable input/output (configurable I/O) during device commissioning.

The following inputs and outputs are available for assignment:

- Choice of current output: 4 to 20 mA (active), 0/4 to 20 mA (passive)
- Pulse/frequency/switch output
- Choice of current input: 4 to 20 mA (active), 0/4 to 20 mA (passive)
- Status input

Signal on alarm

Depending on the interface, failure information is displayed as follows:

PROFINET

Device diagnostics	According to "Application Layer protocol for decentralized periphery", Version 2.3
---------------------------	--

Current output 0/4 to 20 mA

4 to 20 mA

Failure mode	<p>Choose from:</p> <ul style="list-style-type: none"> ▪ 4 to 20 mA in accordance with NAMUR recommendation NE 43 ▪ 4 to 20 mA in accordance with US ▪ Min. value: 3.59 mA ▪ Max. value: 22.5 mA ▪ Definable value between: 3.59 to 22.5 mA ▪ Actual value ▪ Last valid value
---------------------	--

0 to 20 mA

Failure mode	Choose from: <ul style="list-style-type: none"> ■ Maximum alarm: 22 mA ■ Definable value between: 0 to 20.5 mA
---------------------	--

Pulse/frequency/switch output

Pulse output	
Fault mode	Choose from: <ul style="list-style-type: none"> ■ Actual value ■ No pulses
Frequency output	
Fault mode	Choose from: <ul style="list-style-type: none"> ■ Actual value ■ 0 Hz ■ Definable value between: 2 to 12 500 Hz
Switch output	
Fault mode	Choose from: <ul style="list-style-type: none"> ■ Current status ■ Open ■ Closed

Relay output

Failure mode	Choose from: <ul style="list-style-type: none"> ■ Current status ■ Open ■ Closed
---------------------	---

Local display

Plain text display	With information on cause and remedial measures
Backlight	Red lighting indicates a device error.

 Status signal as per NAMUR recommendation NE 107

Interface/protocol



- Via digital communication:
 - PROFINET
- Via service interface
 - CDI-RJ45 service interface
 - WLAN interface

Plain text display	With information on cause and remedial measures
---------------------------	---

Web browser

Plain text display	With information on cause and remedial measures
---------------------------	---

Light emitting diodes (LED)

Status information	Status indicated by various light emitting diodes The following information is displayed depending on the device version: <ul style="list-style-type: none"> ▪ Supply voltage active ▪ Data transmission active ▪ Device alarm/error has occurred ▪ PROFINET network available ▪ PROFINET connection established ▪ PROFINET blinking feature  Diagnostic information via light emitting diodes →  157
---------------------------	--

Low flow cut off The switch points for low flow cut off are user-selectable.

Galvanic isolation The outputs are galvanically isolated:

- from the power supply
- from one another
- from the potential equalization (PE) terminal

protocol-specific data	Protocol	Application layer protocol for decentral device periphery and distributed automation, Version 2.3
	Communication type	100 MBit/s
	Conformance Class	Conformance Class B
	Netload Class	Netload Class 2 0 Mbps
	Baud rates	Automatic 100 Mbit/s with full-duplex detection
	Cycle times	From 8 ms
	Polarity	Auto-polarity for automatic correction of crossed TxD and RxD pairs
	Media Redundancy Protocol (MRP)	Yes
	System redundancy support	System redundancy S2 (2 AR with 1 NAP)
	Device profile	Application interface identifier 0xF600 Generic device
	Manufacturer ID	0x11
	Device type ID	0x843B
	Device description files (GSD, DTM, DD)	Information and files under: <ul style="list-style-type: none"> ▪ www.endress.com On the product page for the device: Documents/Software → Device drivers ▪ www.profibus.com
Supported connections	<ul style="list-style-type: none"> ▪ 2 x AR (IO Controller AR) ▪ 1 x AR (IO-Supervisor Device AR connection allowed) ▪ 1 x Input CR (Communication Relation) ▪ 1 x Output CR (Communication Relation) ▪ 1 x Alarm CR (Communication Relation) 	
Configuration options for measuring device	<ul style="list-style-type: none"> ▪ DIP switches on the electronics module, for device name assignment (last part) ▪ Asset management software (FieldCare, DeviceCare, Field Xpert) ▪ Integrated Web server via Web browser and IP address ▪ Device master file (GSD), can be read out via the integrated Web server of the measuring device. ▪ Onsite operation 	

Configuration of the device name	<ul style="list-style-type: none"> ▪ DIP switches on the electronics module, for device name assignment (last part) ▪ DCP protocol ▪ Asset management software (FieldCare, DeviceCare, Field Xpert) ▪ Integrated Web server
Supported functions	<ul style="list-style-type: none"> ▪ Identification & Maintenance, simple device identifier via: <ul style="list-style-type: none"> ▪ Control system ▪ Nameplate ▪ Measured value status The process variables are communicated with a measured value status ▪ Blinking feature via the local display for simple device identification and assignment ▪ Device operation via asset management software (e.g. FieldCare, DeviceCare, SIMATIC PDM)
System integration	<p>Information regarding system integration .</p> <ul style="list-style-type: none"> ▪ Cyclic data transmission ▪ Overview and description of the modules ▪ Status coding ▪ Startup configuration ▪ Factory setting

16.5 Power supply

Terminal assignment →  35

Available device plugs →  35

Available device plugs →  35

Supply voltage

Order code "Power supply"	Terminal voltage		Frequency range
Option D	DC 24 V	±20%	–
Option E	AC 100 to 240 V	–15...+10%	50/60 Hz
Option I	DC 24 V	±20%	–
	AC 100 to 240 V	–15...+10%	50/60 Hz

Power consumption

Transmitter

Max. 10 W (active power)

switch-on current	Max. 36 A (<5 ms) as per NAMUR Recommendation NE 21
--------------------------	---

Current consumption

Transmitter

- Max. 400 mA (24 V)
- Max. 200 mA (110 V, 50/60 Hz; 230 V, 50/60 Hz)

Power supply failure

- Totalizers stop at the last value measured.
- Depending on the device version, the configuration is retained in the device memory or in the pluggable data memory (HistoROM DAT).
- Error messages (incl. total operated hours) are stored.

Overcurrent protection element The device must be operated with a dedicated circuit breaker, as it does not have an ON/OFF switch of its own.

- The circuit breaker must be easy to reach and labeled accordingly.
- Permitted nominal current of the circuit breaker: 2 A up to maximum 10 A.

Electrical connection →  36

Potential equalization →  41

Terminals Spring-loaded terminals: Suitable for strands and strands with ferrules.
Conductor cross-section 0.2 to 2.5 mm² (24 to 12 AWG).

Cable entries

- Cable gland: M20 × 1.5 with cable Ø 6 to 12 mm (0.24 to 0.47 in)
- Thread for cable entry:
 - NPT ½"
 - G ½"
 - M20



Cable specification →  32

Overvoltage protection	Mains voltage fluctuations	→  238
	Overvoltage category	Overvoltage category II
	Short-term, temporary overvoltage	Between cable and ground up to 1200 V, for max. 5 s
	Long-term, temporary overvoltage	Between cable and ground up to 500 V

16.6 Performance characteristics

Reference operating conditions

- Error limits based on ISO 11631
- Water
 - +15 to +45 °C (+59 to +113 °F)
 - 2 to 6 bar (29 to 87 psi)
- Data as indicated in the calibration protocol
- Accuracy based on accredited calibration rigs according to ISO 17025

 To obtain measured errors, use the *Applicator* sizing tool →  229

Maximum measurement error o.r. = of reading; 1 g/cm³ = 1 kg/l; T = medium temperature

Base accuracy

 Design fundamentals →  242

Mass flow and volume flow (liquids)

±0.10 % o.r.

Mass flow (gases)

±0.35 % o.r.

Density (liquids)

Under reference conditions	Standard density calibration ¹⁾	Wide-range Density specification ^{2) 3)}
[g/cm ³]	[g/cm ³]	[g/cm ³]
±0.0005	±0.001	±0.002

- 1) For devices with the order code "Measuring tube material, wetted surface", option HB "Alloy C22, high pressure, not polished", the standard density calibration ±0.002 g/cm³
- 2) Valid range for special density calibration: 0 to 2 g/cm³, +5 to +80 °C (+41 to +176 °F)
- 3) order code for "Application package", option EE "Special density"

Temperature

$$\pm 0.5 \text{ °C} \pm 0.005 \cdot T \text{ °C} (\pm 0.9 \text{ °F} \pm 0.003 \cdot (T - 32) \text{ °F})$$

Zero point stability

Standard version: order code for "Measuring tube mat., wetted surface", option BB, BF, HA, SA

DN		Zero point stability	
[mm]	[in]	[kg/h]	[lb/min]
1	1/24	0.0005	0.000018
2	1/12	0.0025	0.00009
4	1/8	0.0100	0.00036

High-pressure version: order code for "Measuring tube mat., wetted surface", option HB

DN		Zero point stability	
[mm]	[in]	[kg/h]	[lb/min]
1	1/24	0.0008	0.0000288
2	1/12	0.0040	0.000144
4	1/8	0.0160	0.000576

Flow values

Flow values as turndown parameters depending on nominal diameter.

SI units

DN [mm]	1:1	1:10	1:20	1:50	1:100	1:500
	[kg/h]	[kg/h]	[kg/h]	[kg/h]	[kg/h]	[kg/h]
1	20	2	1	0.4	0.2	0.04
2	100	10	5	2	1	0.2
4	450	45	22.5	9	4.5	0.9

US units

DN	1:1	1:10	1:20	1:50	1:100	1:500
[inch]	[lb/min]	[lb/min]	[lb/min]	[lb/min]	[lb/min]	[lb/min]
$\frac{1}{24}$	0.735	0.074	0.037	0.015	0.007	0.001
$\frac{1}{12}$	3.675	0.368	0.184	0.074	0.037	0.007
$\frac{1}{8}$	16.54	1.654	0.827	0.331	0.165	0.033

Accuracy of outputs

The outputs have the following base accuracy specifications.

Current output

Accuracy	$\pm 5 \mu\text{A}$
-----------------	---------------------

Pulse/frequency output

o.r. = of reading

Accuracy	Max. $\pm 50 \text{ ppm o.r.}$ (over the entire ambient temperature range)
-----------------	--

Repeatability

o.r. = of reading; $1 \text{ g/cm}^3 = 1 \text{ kg/l}$; T = medium temperature

Base repeatability

 Design fundamentals →  242

Mass flow and volume flow (liquids)

$\pm 0.05 \%$ o.r.

Mass flow (gases)

$\pm 0.15 \%$ o.r.

Density (liquids)

$\pm 0.00025 \text{ g/cm}^3$

Temperature

$\pm 0.25 \text{ }^\circ\text{C} \pm 0.0025 \cdot T \text{ }^\circ\text{C}$ ($\pm 0.45 \text{ }^\circ\text{F} \pm 0.0015 \cdot (T-32) \text{ }^\circ\text{F}$)

Response time

The response time depends on the configuration (damping).

Influence of ambient temperature

Current output

Temperature coefficient	Max. $1 \mu\text{A}/^\circ\text{C}$
--------------------------------	-------------------------------------

Pulse/frequency output

Temperature coefficient	No additional effect. Included in accuracy.
--------------------------------	---

Influence of medium temperature

Mass flow

o.f.s. = of full scale value

If there is a difference between the temperature during zero adjustment and the process temperature, the additional measurement error of the sensors is typically $\pm 0.0002\% \text{ o.f.s./}^\circ\text{C}$ ($\pm 0.0001\% \text{ o.f.s./}^\circ\text{F}$).

The influence is reduced when the zero adjustment is performed at process temperature.

Density

If there is a difference between the density calibration temperature and the process temperature, the measurement error of the sensors is typically $\pm 0.00005 \text{ g/cm}^3/^\circ\text{C}$ ($\pm 0.000025 \text{ g/cm}^3/^\circ\text{F}$). Field density adjustment is possible.

Wide-range density specification (special density calibration)

If the process temperature is outside the valid range (\rightarrow  239) the measurement error is $\pm 0.00005 \text{ g/cm}^3/^\circ\text{C}$ ($\pm 0.000025 \text{ g/cm}^3/^\circ\text{F}$)

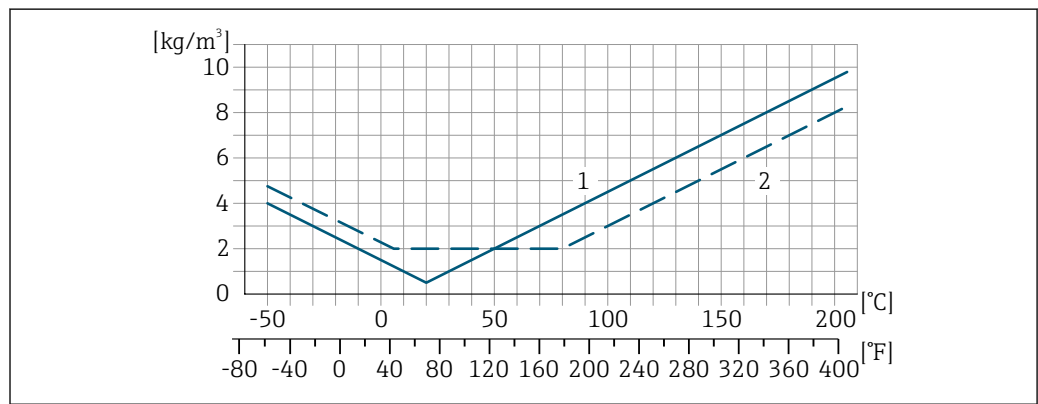

1 Field density adjustment, for example at $+20^\circ\text{C}$ ($+68^\circ\text{F}$)
 2 Special density calibration

Influence of medium pressure

A difference between the calibration pressure and process pressure does not affect accuracy.

Influence of process density

If there is a difference in density between the calibration density and the process density, the measurement error for the measured density is typically:

- $\pm 0.6\%$ for nominal diameter DN 4 ($1/24 \text{ in}$)
- $\pm 1.4\%$ for nominal diameter DN 2 ($1/12 \text{ in}$)
- $\pm 2.0\%$ for nominal diameter DN 1 ($1/12 \text{ in}$) and for devices with order code for "Measuring tube material, wetted surface:", option HB "Alloy C22, high pressure, not polished"

 A field density adjustment is possible.

Design fundamentals

o.r. = of reading, o.f.s. = of full scale value

BaseAccu = base accuracy in % o.r., BaseRepeat = base repeatability in % o.r.

MeasValue = measured value; ZeroPoint = zero point stability

Calculation of the maximum measured error as a function of the flow rate

Flow rate	Maximum measured error in % o.r.
$\geq \frac{\text{ZeroPoint}}{\text{BaseAccu}} \cdot 100$ <small>A0021332</small>	$\pm \text{BaseAccu}$ <small>A0021339</small>
$< \frac{\text{ZeroPoint}}{\text{BaseAccu}} \cdot 100$ <small>A0021333</small>	$\pm \frac{\text{ZeroPoint}}{\text{MeasValue}} \cdot 100$ <small>A0021334</small>

Calculation of the maximum repeatability as a function of the flow rate

Flow rate	Maximum repeatability in % o.r.
$\geq \frac{1/2 \cdot \text{ZeroPoint}}{\text{BaseRepeat}} \cdot 100$ <small>A0021335</small>	$\pm \text{BaseRepeat}$ <small>A0021340</small>
$< \frac{1/2 \cdot \text{ZeroPoint}}{\text{BaseRepeat}} \cdot 100$ <small>A0021336</small>	$\pm 1/2 \cdot \frac{\text{ZeroPoint}}{\text{MeasValue}} \cdot 100$ <small>A0021337</small>

Example of maximum measurement error

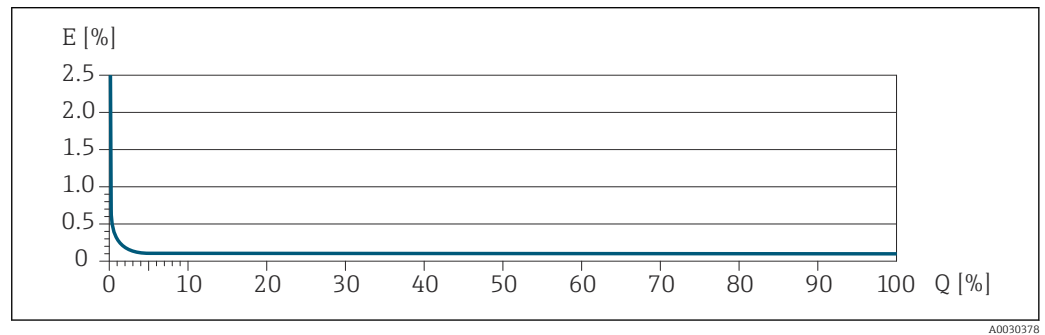

E Maximum measurement error in % o.r. (example)
 Q Flow rate in % of maximum full scale value



16.7 Mounting

Mounting requirements → 21

16.8 Environment

Ambient temperature range → 23

Temperature tables

-  Observe the interdependencies between the permitted ambient and fluid temperatures when operating the device in hazardous areas.
-  For detailed information on the temperature tables, see the separate document entitled "Safety Instructions" (XA) for the device.

Storage temperature

Climate class	DIN EN 60068-2-38 (test Z/AD)
Relative humidity	The device is suitable for use outdoors and indoors with a relative humidity of 4 to 95 %.
Operating height	According to EN 61010-1 <ul style="list-style-type: none"> ■ ≤ 2 000 m (6 562 ft) ■ > 2 000 m (6 562 ft) with additional overvoltage protection (e.g. Endress+Hauser HAW Series)
Degree of protection	<p>Transmitter</p> <ul style="list-style-type: none"> ■ IP66/67, Type 4X enclosure, suitable for pollution degree 4 ■ When the housing is open: IP20, Type 1 enclosure, suitable for pollution degree 2 ■ Display module: IP20, Type 1 enclosure, suitable for pollution degree 2 <p>Optional</p> <p>Order code for "Sensor options", option CM "IP69"</p> <p>External WLAN antenna</p> <p>IP67</p>
Shock and vibration resistance	<p>Vibration sinusoidal, in accordance with IEC 60068-2-6</p> <ul style="list-style-type: none"> ■ 2 to 8.4 Hz, 3.5 mm peak ■ 8.4 to 2 000 Hz, 1 g peak <p>Vibration broad-band random, according to IEC 60068-2-64</p> <ul style="list-style-type: none"> ■ 10 to 200 Hz, 0.003 g²/Hz ■ 200 to 2 000 Hz, 0.001 g²/Hz ■ Total: 1.54 g rms <p>Shock half-sine, according to IEC 60068-2-27</p> <p>6 ms 30 g</p> <p>Rough handling shocks according to IEC 60068-2-31</p>
Internal cleaning	<ul style="list-style-type: none"> ■ CIP cleaning ■ SIP cleaning <p>Options</p> <p>Oil- and grease-free version for wetted parts, without declaration Order code for "Service", option HA ⁴⁾</p>
Mechanical load	<p>Transmitter housing:</p> <ul style="list-style-type: none"> ■ Protect against mechanical effects, such as shock or impact ■ Do not use as a ladder or climbing aid

4) The cleaning refers to the measuring instrument only. Any accessories supplied are not cleaned.

Electromagnetic compatibility (EMC)

- As per IEC/EN 61326 and NAMUR Recommendation 21 (NE 21)
- As per IEC/EN 61000-6-2 and IEC/EN 61000-6-4



Details are provided in the Declaration of Conformity.



This unit is not intended for use in residential environments and cannot guarantee adequate protection of the radio reception in such environments.

16.9 Process

Medium temperature range -50 to +205 °C (-58 to +401 °F)

Pressure-temperature ratings



For an overview of the pressure-temperature ratings for the process connections, see the Technical Information

Sensor housing

The sensor housing is filled with dry nitrogen gas and protects the electronics and mechanics inside.



If a measuring tube fails (e.g. due to process characteristics like corrosive or abrasive fluids), the fluid will initially be contained by the sensor housing.

In the event of a tube failure, the pressure level inside the sensor housing will rise according to the operating process pressure. If the user judges that the sensor housing burst pressure does not provide an adequate safety margin, the device can be fitted with a rupture disk. This prevents excessively high pressure from forming inside the sensor housing. Therefore, the use of a rupture disk is strongly recommended in applications involving high gas pressures, and particularly in applications in which the process pressure is greater than 2/3 of the sensor housing burst pressure.



High-pressure devices are always fitted with a rupture disk: order code for "Measuring tube mat., wetted surface", option HB

Burst pressure of the sensor housing

If the device is fitted with a rupture disk (order code for "Sensor option", option CA "Rupture disk"), the rupture disk trigger pressure is decisive.

The sensor housing burst pressure refers to a typical internal pressure which is reached prior to mechanical failure of the sensor housing and which was determined during type testing. The corresponding type test declaration can be ordered with the device (order code for "Additional approval", option LN "Sensor housing burst pressure, type test").

DN		Sensor housing burst pressure	
[mm]	[in]	[bar]	[psi]
1	1/24	220	3 190
2	1/12	140	2 030
4	1/8	105	1 520



For information on the dimensions: see the "Mechanical construction" section of the "Technical Information" document

Rupture disk

To increase the level of safety, a device version with a rupture disk with a trigger pressure of 10 to 15 bar (145 to 217.5 psi) can be used (order code for "Sensor option", option CA "rupture disk").

Drain connection for rupture disk

To allow any escaping medium to drain in a controlled manner in the event of an error, an optional drain connection can be ordered in addition to the rupture disk.



 The function of the rupture disk is not compromised in any way.

Flow limit



Select the nominal diameter by optimizing between the required flow range and permissible pressure loss.

 For an overview of the full scale values for the measuring range, see the "Measuring range" section →  231

- The minimum recommended full scale value is approx. 1/20 of the maximum full scale value
- In most applications, 20 to 50 % of the maximum full scale value can be considered ideal
- A low full scale value must be selected for abrasive media (such as liquids with entrained solids): flow velocity < 1 m/s (< 3 ft/s).
- For gas measurement the following rules apply:
 - The flow velocity in the measuring tubes should not exceed half the sound velocity (0.5 Mach).
 - The maximum mass flow depends on the density of the gas: formula

 To calculate the flow limit, use the *Applicator* sizing tool →  229

Pressure loss

 To calculate the pressure loss, use the *Applicator* sizing tool →  229

System pressure

→  23

16.10 Mechanical construction

Design, dimensions

 For the dimensions and installation lengths of the device, see the "Technical Information" document, "Mechanical construction" section

Weight

All values (weight exclusive of packaging material) refer to devices with VCO couplings. Weight specifications including transmitter as per order code for "Housing", option A "Aluminum, coated".

Different values due to different transmitter versions:

- Transmitter version for the hazardous area
(Order code for "Housing", option A "Aluminum, coated"; Ex d): +2 kg (+4.4 lbs)
- Transmitter version for hygienic area
(Order code for "Housing", option B "Stainless, hygienic"): +0.2 kg (+0.44 lbs)

Weight in SI units

DN [mm]	Weight [kg]
1	5.35
2	6.9
4	8.75

Weight in US units

DN [in]	Weight [lbs]
1/24	12
1/12	15
1/8	19

Materials**Transmitter housing**

Order code for "Housing":

- Option A "Aluminum, coated": aluminum, AlSi10Mg, coated
- Option B "Stainless, hygienic": stainless steel, 1.4404 (316L)

Window material

Order code for "Housing":

- Option A "Aluminum, coated": glass
- Option B "Stainless, hygienic": polycarbonate

Seals

Order code for "Housing":

Option B "Stainless, hygienic": EPDM and silicone

Cable entries/cable glands

Order code for "Housing", option A "Aluminum, coated"

The various cable entries are suitable for hazardous and non-hazardous areas.

Cable entry/cable gland	Material
Compression fitting M20 × 1.5	Non-Ex: plastic
	Z2, D2, Ex d/de: brass with plastic
Adapter for cable entry with female thread G ½"	Nickel-plated brass
Adapter for cable entry with female thread NPT ½"	

Order code for "Housing", option B "Stainless, hygienic"

The various cable entries are suitable for hazardous and non-hazardous areas.

Cable entry/cable gland	Material
Cable gland M20 × 1.5	Plastic
Adapter for cable entry with female thread G ½"	Nickel-plated brass
Adapter for cable entry with female thread NPT ½"	

Sensor housing

- Acid and alkali-resistant outer surface
- Stainless steel, 1.4404 (316L)

Measuring tubes

Order code for "Measuring tube mat., wetted surface", option BB, BF, SA

Stainless steel, 1.4435 (316/316L)

Order code for "Measuring tube mat., wetted surface", option HA, HB, HC, HD
 Alloy C22, 2.4602 (UNS N06022)

Process connections

Order code for "Measuring tube mat., wetted surface", option SA

VCO coupling	Stainless steel, 1.4404 (316/316L)
G¼", G½" female thread	Stainless steel, 1.4404 (316/316L)
NPT¾", NPT½" female thread	Stainless steel, 1.4404 (316/316L)
Tri-Clamp½"	Stainless steel, 1.4435 (316L)
Fixed flange EN 1092-1, ASME B16.5, JIS B2220	Stainless steel, 1.4404 (316/316L)

Order code for "Measuring tube mat., wetted surface", option BB, BF

VCO coupling	Stainless steel, 1.4404 (316/316L)
Tri-Clamp½"	Stainless steel, 1.4435 (316L)

Order code for "Measuring tube mat., wetted surface", option HC, HD



VCO coupling	Alloy C22, 2.4602 (UNS N06022)
Tri-Clamp½"	Alloy C22, 2.4602 (UNS N06022)

Order code for "Measuring tube mat., wetted surface", option HA

VCO coupling	Alloy C22, 2.4602 (UNS N06022)
G¼", G½" female thread	Alloy C22, 2.4602 (UNS N06022)
NPT¾", NPT½" female thread	Alloy C22, 2.4602 (UNS N06022)
Fixed flange EN 1092-1, ASME B16.5, JIS B2220	Alloy C22, 2.4602 (UNS N06022)
Lap joint flange EN 1092-1, ASME B16.5, JIS B2220	Stainless steel, 1.4301 (F304), wetted parts Alloy C22, 2.4602 (UNS N06022)

Order code for "Measuring tube mat., wetted surface", option HB (high-pressure option)

VCO coupling	Alloy C22, 2.4602 (UNS N06022)
G¼", G½" female thread	Alloy C22, 2.4602 (UNS N06022)
NPT¾", NPT½" female thread	Alloy C22, 2.4602 (UNS N06022)
Fixed flange EN 1092-1, ASME B16.5, JIS B2220	Stainless steel, 1.4404 (316/316L); Alloy C22, 2.4602 (UNS N06022)

 Available process connections →  249

Seals

Welded process connections without internal seals

Accessories

Sensor holder

Stainless steel, 1.4404 (316L)

Heating jacket

- Heating jacket housing: stainless steel, 1.4571 (316Ti)
- NPT adapter ½": stainless steel, 1.4404 (316)
- G½" adapter: stainless steel, 1.4404

Protective cover

Stainless steel, 1.4404 (316L)

External WLAN antenna

- Antenna: ASA plastic (acrylonitrile styrene acrylate) and nickel-plated brass
- Adapter: Stainless steel and nickel-plated brass
- Cable: Polyethylene
- Plug: Nickel-plated brass
- Angle bracket: Stainless steel

Process connections

- Fixed flange connections:
 - EN 1092-1 (DIN 2501) flange
 - EN 1092-1 (DIN 2512N) flange
 - ASME B16.5 flange
 - JIS B2220 flange
- Clamp connections:
 - Tri-Clamp (OD tubes), DIN 11866 series C
- VCO connections:
 - 4-VCO-4
- Internal thread:
 - Cylindrical internal thread BSPP (G) in accordance with ISO 228-1
 - NPT

 Process connection materials →  248

Surface roughness

All data refer to parts in contact with the medium.

The following surface roughness categories can be ordered:

Category	Method	Option(s) order code "Measuring tube mat., wetted surface"
Not polished	–	HA, HB, SA
Ra ≤ 0.76 µm (30 µin) ¹⁾	Mechanically polished ²⁾	BB, HC
Ra ≤ 0.38 µm (15 µin) ¹⁾	Mechanically polished ²⁾	BF, HD

1) Ra according to ISO 21920

2) Except for inaccessible welds between pipe and manifold

16.11 Operability

Languages

Can be operated in the following languages:



- Via local operation
English, German, French, Spanish, Italian, Dutch, Portuguese, Polish, Russian, Turkish, Chinese, Japanese, Korean, Vietnamese, Czech, Swedish
- Via web browser
English, German, French, Spanish, Italian, Dutch, Portuguese, Polish, Russian, Turkish, Chinese, Japanese, Vietnamese, Czech, Swedish
- Via "FieldCare", "DeviceCare" operating tool: English, German, French, Spanish, Italian, Chinese, Japanese

Onsite operation

Via display module

Features:

- Order code for "Display; operation", option F "4-line, illuminated, graphic display; touch control"
- Order code for "Display; operation", option G "4-line, illuminated, graphic display; touch control + WLAN"

 Information about WLAN interface →  72

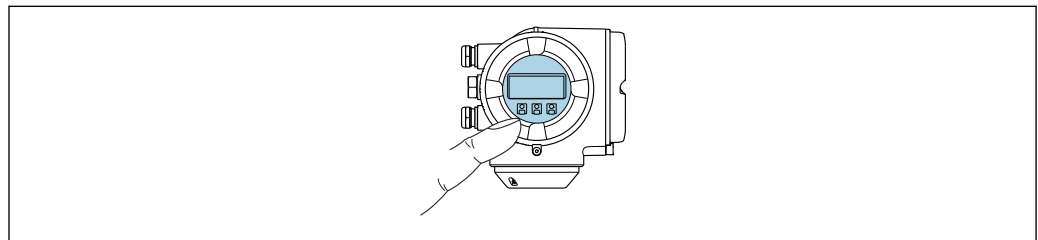



A0026785

 35 Operation with touch control



Display elements

- 4-line, illuminated, graphic display
- White background lighting; switches to red in event of device errors
- Format for displaying measured variables and status variables can be individually configured

Operating elements

- External operation via touch control (3 optical keys) without opening the housing: , , 
- Operating elements also accessible in the various zones of the hazardous area

Via remote display and operating module DKX001

 The remote display and operating module DKX001 is available as an optional extra →  227..

- The remote display and operating module DKX001 is only available for the following housing version: order code for "Housing": option A "Aluminum, coated"
- The measuring instrument is always supplied with a dummy cover when the remote display and operating module DKX001 is ordered directly with the measuring instrument. Display or operation at the transmitter is not possible in this case.
- If ordered subsequently, the remote display and operating module DKX001 may not be connected at the same time as the existing measuring instrument display module. Only one display or operation unit may be connected to the transmitter at any one time.

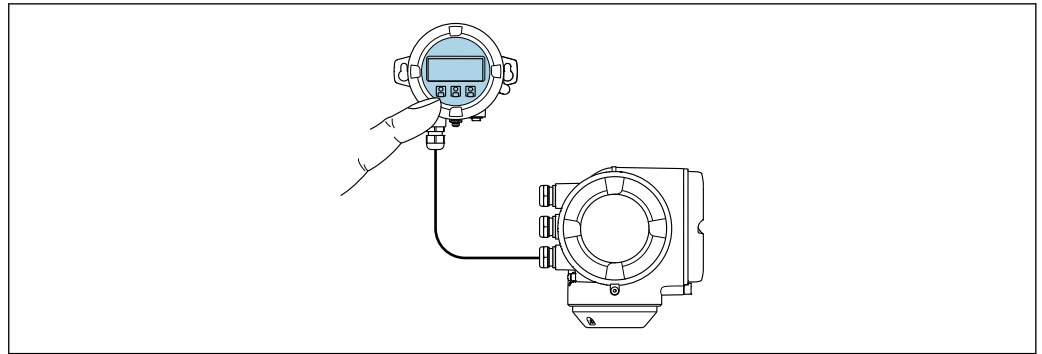

A0026786

36 Operation via remote display and operating module DKX001

Display and operating elements

The display and operating elements correspond to those of the display module → 250.

Housing material

The housing material of the display and operating module DKX001 depends on the choice of transmitter housing material.

Transmitter housing		Remote display and operating module
Order code for "Housing"	Material	Material
Option A "Aluminum, coated"	AlSi10Mg, coated	AlSi10Mg, coated

Cable entry

Corresponds to the choice of transmitter housing, order code for "Electrical connection".

Connecting cable

→ 33

Dimensions







Information on the dimensions:

"Mechanical construction" section of the "Technical Information" document.

Remote operation → 70

Service interface → 71

Supported operating tools Different operating tools can be used for local or remote access to the measuring device. Depending on the operating tool used, access is possible with different operating units and via a variety of interfaces.

Supported operating tools	Operating unit	Interface	Additional information
Web browser	Notebook, PC or tablet with Web browser	<ul style="list-style-type: none"> ■ CDI-RJ45 service interface ■ WLAN interface ■ Ethernet-based fieldbus (EtherNet/IP, PROFINET) 	Special Documentation for device →  259
DeviceCare SFE100	Notebook, PC or tablet with Microsoft Windows system	<ul style="list-style-type: none"> ■ CDI-RJ45 service interface ■ WLAN interface ■ Fieldbus protocol 	→  229
FieldCare SFE500	Notebook, PC or tablet with Microsoft Windows system	<ul style="list-style-type: none"> ■ CDI-RJ45 service interface ■ WLAN interface ■ Fieldbus protocol 	→  229
Field Xpert	SMT70/77/50	<ul style="list-style-type: none"> ■ All fieldbus protocols ■ WLAN interface ■ Bluetooth ■ CDI-RJ45 service interface 	Operating Instructions BA01202S Device description files: Use update function of handheld terminal
SmartBlue app	Smartphone or tablet with iOS or Android	WLAN	→  229

 Other operating tools based on FDT technology with a device driver such as DTM/iDTM or DD/EDD can be used for device operation. These operating tools are available from the individual manufacturers. Integration into the following operating tools, among others, is supported:

- Field Device Manager (FDM) from Honeywell → www.process.honeywell.com
- FieldMate from Yokogawa → www.yokogawa.com
- PACTWare → www.pactware.com

The related device description files are available: www.endress.com → Download Area

Web server

With the integrated web server, the device can be operated and configured via a web browser and via the service interface (CDI-RJ45) or WLAN interface. The structure of the operating menu is the same as for the local display. In addition to the measured values, status information on the device is displayed and can be used to monitor device health. Furthermore the device data can be managed and the network parameters can be configured.

A device that has a WLAN interface (can be ordered as an option) is required for the WLAN connection: order code for "Display; operation", option G "4-line, illuminated; touch control + WLAN". The device acts as an Access Point and enables communication by computer or a mobile handheld terminal.

Supported functions

Data exchange between the operating unit (such as a notebook, for example,) and measuring instrument:

- Upload the configuration from the measuring instrument (XML format, configuration backup)
- Save the configuration to the measuring instrument (XML format, restore configuration)
- Export event list (.csv file)
- Export parameter settings (.csv file or PDF file, document the measuring point configuration)
- Export the Heartbeat Technology verification report (PDF file, only available with the **Heartbeat Verification** →  257 application package)

- Flash firmware version for device firmware upgrade, for example
- Download driver for system integration
- Visualize up to 1000 saved measured values (only available with the **Extended HistoROM** application package →  257)

HistoROM data management

The measuring device features HistoROM data management. HistoROM data management comprises both the storage and import/export of key device and process data, making operation and servicing far more reliable, secure and efficient.

 When the device is delivered, the factory settings of the configuration data are stored as a backup in the device memory. This memory can be overwritten with an updated data record, for example after commissioning.

Additional information on the data storage concept

There are different types of data storage units in which device data are stored and used by the device:

	HistoROM backup	T-DAT	S-DAT
Available data	<ul style="list-style-type: none"> ▪ Event logbook, e.g. diagnostic events ▪ Parameter data record backup ▪ Device firmware package ▪ Driver for system integration for exporting via web server, e.g.: GSDML for PROFINET 	<ul style="list-style-type: none"> ▪ Measured value logging ("Extended HistoROM" order option) ▪ Current parameter data record (used by firmware at run time) ▪ Indicator (minimum/maximum values) ▪ Totalizer value 	<ul style="list-style-type: none"> ▪ Sensor data: e.g. nominal diameter ▪ Serial number ▪ Calibration data ▪ Device configuration (e.g. SW options, fixed I/O or multi I/O)
Storage location	Fixed on the user interface PC board in the connection compartment	Can be plugged into the user interface PC board in the connection compartment	In the sensor plug in the transmitter neck part

Data backup

Automatic

- The most important device data (sensor and transmitter) are automatically saved in the DAT modules
- If the transmitter or measuring device is replaced: once the T-DAT containing the previous device data has been exchanged, the new measuring device is ready for operation again immediately without any errors
- If exchanging the electronics module (e.g. I/O electronics module): Once the electronics module has been replaced, the software of the module is compared against the current device firmware. The module software is upgraded or downgraded where necessary. The electronics module is available for use immediately afterwards and no compatibility problems occur.

Manual

Additional parameter data record (complete parameter settings) in the integrated device memory HistoROM backup for:

- Data backup function
Backup and subsequent restoration of a device configuration in the device memory HistoROM backup
- Data comparison function
Comparison of the current device configuration with the device configuration saved in the device memory HistoROM backup

Data transmission

Manual

- Transfer of a device configuration to another device using the export function of the specific operating tool, e.g. with FieldCare, DeviceCare or Web server: to duplicate the configuration or to store in an archive (e.g. for backup purposes)
- Transmission of the drivers for system integration via Web server, e.g.: GSDML for PROFINET

Event list

Automatic

- Chronological display of up to 20 event messages in the events list
- If the **Extended HistoROM** application package (order option) is enabled: up to 100 event messages are displayed in the events list along with a time stamp, plain text description and remedial measures
- The events list can be exported and displayed via a variety of interfaces and operating tools e.g. DeviceCare, FieldCare or Web server

Data logging

Manual

If the **Extended HistoROM** application package (order option) is enabled:

- Recording of 1 to 4 channels of up to 1 000 measured values (up to 250 measured values per channel)
- User configurable recording interval
- Export the measured value log via a variety of interfaces and operating tools e.g. FieldCare, DeviceCare or web server

16.12 Certificates and approvals

Current certificates and approvals for the product are available at www.endress.com on the relevant product page:

1. Select the product using the filters and search field.
2. Open the product page.
3. Select **Downloads**.

CE mark

The device meets the legal requirements of the applicable EU Directives. These are listed in the corresponding EU Declaration of Conformity along with the standards applied.

Endress+Hauser confirms successful testing of the device by affixing to it the CE mark.

UKCA marking



The device meets the legal requirements of the applicable UK regulations (Statutory Instruments). These are listed in the UKCA Declaration of Conformity along with the designated standards. By selecting the order option for UKCA marking, Endress+Hauser confirms a successful evaluation and testing of the device by affixing the UKCA mark.

Contact address Endress+Hauser UK:

Endress+Hauser Ltd.
Floats Road
Manchester M23 9NF
United Kingdom
www.uk.endress.com

Hygienic compatibility	<ul style="list-style-type: none"> ■ 3-A approval <ul style="list-style-type: none"> ■ Only measuring instruments with the order code for "Additional approval", option LP "3A" have 3-A approval. ■ The 3-A approval refers to the measuring instrument. ■ When installing the measuring instrument, ensure that no liquid can accumulate on the outside of the measuring instrument. A remote display module must be installed in accordance with the 3-A Standard. ■ Accessories (e.g. heating jacket, weather protection cover, wall holder unit) must be installed in accordance with the 3-A Standard. Each accessory can be cleaned. Disassembly may be necessary under certain circumstances. ■ FDA ■ Food Contact Materials Regulation (EC) 1935/2004 <p> Observe the special installation instructions</p>
------------------------	---

Certification PROFINET	<p>PROFINET interface</p> <p>The measuring device is certified and registered by the PNO (PROFIBUS Nutzerorganisation e.V. / PROFIBUS User Organization). The measuring system meets all the requirements of the following specifications:</p> <ul style="list-style-type: none"> ■ Certified according to: <ul style="list-style-type: none"> ■ Test specification for PROFINET devices ■ PROFINET Security Level 2 – Netload Class 2 0 Mbps ■ The device can also be operated with certified devices of other manufacturers (interoperability) ■ The device supports PROFINET S2 system redundancy.
------------------------	--

Radio approval	<p>The measuring device has radio approval.</p> <p> For detailed information on the radio approval, see the Special Documentation →  259</p>
----------------	--

Additional certification	<p>CRN approval</p> <p>Some device versions have CRN approval. A CRN-approved process connection with a CSA approval must be ordered for a CRN-approved device.</p> <p>Tests and certificates</p> <ul style="list-style-type: none"> ■ Radiographic testing ISO 10675-1 ZG1 (RT), process connection, weld seam, Heartbeat Technology verification report ■ Radiographic testing ASME B31.3 NFS (RT), process connection, weld seam, Heartbeat Technology verification report ■ Radiographic testing ASME VIII Div.1 (RT), process connection, weld seam, Heartbeat Technology verification report ■ Radiographic testing NORSOK M-601 (RT), process connection, weld seam, Heartbeat Technology verification report ■ Radiographic testing ISO 10675-1 ZG1 (DR), process connection, weld seam, Heartbeat Technology verification report ■ Radiographic testing ASME B31.3 NFS (DR), process connection, weld seam, Heartbeat Technology verification report ■ Radiographic testing ASME VIII Div.1 (DR), process connection, weld seam, Heartbeat Technology verification report ■ Radiographic testing NORSOK M-601 (DR), process connection, weld seam, Heartbeat Technology verification report
--------------------------	--

Testing of welded connections

Option	Test standard				Process connection
	ISO 10675-1 AL1	ASME B31.3 NFS	ASME VIII Div.1	NORSOK M-601	
KE	x				RT
KI		x			RT
KN			x		RT
KS				x	RT
K5	x				DR
K6		x			DR
K7			x		DR
K8				x	DR
RT = Radiographic testing, DR = Digital radiography All options with test report					



External standards and guidelines



- EN 60529
Degrees of protection provided by enclosures (IP code)
- IEC/EN 60068-2-6
Environmental influences: Test procedure - Test Fc: vibrate (sinusoidal).
- IEC/EN 60068-2-31
Environmental influences: Test procedure - Test Ec: shocks due to rough handling, primarily for devices.
- EN 61010-1
Safety requirements for electrical equipment for measurement, control and laboratory use - general requirements
- EN 61326-1/-2-3
EMC requirements for electrical equipment for measurement, control and laboratory use
- NAMUR NE 21
Electromagnetic compatibility (EMC) of industrial process and laboratory control equipment
- NAMUR NE 32
Data retention in the event of a power failure in field and control instruments with microprocessors
- NAMUR NE 43
Standardization of the signal level for the breakdown information of digital transmitters with analog output signal.
- NAMUR NE 53
Software of field devices and signal-processing devices with digital electronics
- NAMUR NE 105
Specifications for integrating fieldbus devices in engineering tools for field devices
- NAMUR NE 107
Self-monitoring and diagnosis of field devices
- NAMUR NE 131
Requirements for field devices for standard applications
- NAMUR NE 132
Coriolis mass meter
- ETSI EN 300 328
Guidelines for 2.4 GHz radio components.
- EN 301489
Electromagnetic compatibility and radio spectrum matters (ERM).

16.13 Application packages

Many different application packages are available to enhance the functionality of the device. Such packages might be needed to address safety aspects or specific application requirements.

The application packages can be ordered with the device or subsequently from Endress+Hauser. Detailed information on the order code in question is available from your local Endress+Hauser sales center or on the product page of the Endress+Hauser website: www.endress.com.

 Detailed information on the application packages:
Special Documentation →  259

Diagnostic functionality	<p>Order code for "Application package", option EA "Extended HistoROM"</p> <p>Comprises extended functions concerning the event log and the activation of the measured value memory.</p> <p>Event log: Memory volume is extended from 20 message entries (standard version) to up to 100 entries.</p> <p>Data logging (line recorder):</p> <ul style="list-style-type: none"> ▪ Memory capacity for up to 1000 measured values is activated. ▪ 250 measured values can be output via each of the 4 memory channels. The recording interval can be defined and configured by the user. ▪ Measured value logs can be accessed via the local display or operating tool e.g. FieldCare, DeviceCare or Web server. <p> For detailed information, see the Operating Instructions for the device.</p>
Heartbeat Technology	<p>Order code for "Application package", option EB "Heartbeat Verification + Monitoring"</p> <p>Heartbeat Verification Meets the requirement for traceable verification to DIN ISO 9001:2008 Chapter 7.6 a) "Control of monitoring and measuring equipment".</p> <ul style="list-style-type: none"> ▪ Functional testing in the installed state without interrupting the process. ▪ Traceable verification results on request, including a report. ▪ Simple testing process via local operation or other operating interfaces. ▪ Clear measuring point assessment (pass/fail) with high test coverage within the framework of manufacturer specifications. ▪ Extension of calibration intervals according to operator's risk assessment. <p>Heartbeat Monitoring Continuously supplies data, which are characteristic of the measuring principle, to an external condition monitoring system for the purpose of preventive maintenance or process analysis. These data enable the operator to:</p> <ul style="list-style-type: none"> ▪ Draw conclusions - using these data and other information - about the impact process influences (e.g. corrosion, abrasion, buildup etc.) have on the measuring performance over time. ▪ Schedule servicing in time. ▪ Monitor the process or product quality, e.g. gas pockets . <p> For detailed information, see the Special Documentation for the device.</p>
Concentration measurement	<p>Order code for "Application package", option ED "Concentration"</p> <p>Calculation and outputting of fluid concentrations.</p>

The measured density is converted to the concentration of a substance of a binary mixture using the "Concentration" application package:

- Choice of predefined fluids (e.g. various sugar solutions, acids, alkalis, salts, ethanol etc.).
- Common or user-defined units ("Brix", "Plato", % mass, % volume, mol/l etc.) for standard applications.
- Concentration calculation from user-defined tables.

 For detailed information, see the Special Documentation for the device.

Special density



Order code for "Application package", option EE "Special density"

Many applications use density as a key measured value for monitoring quality or controlling processes. The measuring instrument measures the density of the fluid as standard and makes this value available to the control system.

The "Special Density" application package offers high-precision density measurement over a wide density and temperature range particularly for applications subject to varying process conditions.

 For detailed information, see the Operating Instructions for the device.

16.14 Accessories

 Overview of accessories available to order →  227

16.15 Supplementary documentation

 For an overview of the scope of the associated Technical Documentation, refer to the following:

- *Device Viewer* (www.endress.com/deviceviewer): Enter the serial number from the nameplate
- *Endress+Hauser Operations app*: Enter serial number from nameplate or scan matrix code on nameplate.

Standard documentation **Brief Operating Instructions**

Brief Operating Instructions for the sensor

Measuring instrument	Documentation code
Proline Promass A	KA01282D

Brief Operating Instructions for transmitter

Measuring device	Documentation code
Proline 300	KA01341D

Technical Information

Measuring device	Documentation code
Promass A 300	TI01374D

Description of Device Parameters

Measuring device	Documentation code							PROFINET with Ethernet-APL
	HART	FOUNDATION Fieldbus	PROFIBUS PA	PROFIBUS DP	Modbus RS485	EtherNet/IP	PROFINET	
Promass 300	GP01057D	GP01094D	GP01058D	GP01134D	GP01059D	GP01114D	GP01115D	GP01168D

Supplementary device-dependent documentation

Safety instructions

Safety instructions for electrical equipment for hazardous areas.



Remote display and operating module DKX001

Contents	Documentation code
ATEX/IECEX Ex i	XA01494D
ATEX/IECEX Ex ec	XA01498D
cCSAus IS	XA01499D
cCSAus Ex nA	XA01513D
INMETRO Ex i	XA01500D
INMETRO Ex ec	XA01501D
NEPSI Ex i	XA01502D
NEPSI Ex nA	XA01503D

Special documentation

Contents	Documentation code
Information on the Pressure Equipment Directive	SD01614D
Remote display and operating module DKX001	SD01763D
Radio approvals for WLAN interface for A309/A310 display module	SD01793D
Web server	SD01969D
Heartbeat Technology	SD01988D
Concentration measurement	SD02005D
Gas fraction handler	SD02584D

Installation instructions

Contents	Note
Installation instructions for spare part sets and accessories	<ul style="list-style-type: none"> ▪ Access the overview of all the available spare part sets via <i>Device Viewer</i> →  225 ▪ Accessories available for order with Installation Instructions →  227

Index

- 0 ... 9**
 3-A approval 255
- A**
 Access authorization to parameters
 Read access 62
 Write access 62
 Access code 62
 Incorrect input 62
 Adapting the diagnostic behavior 164
 Additional certification 255
 Ambient conditions
 Mechanical load 244
 Operating height 244
 Relative humidity 244
 Shock and vibration resistance 244
 Storage temperature 243
 Ambient temperature
 Influence 241
 Ambient temperature range 244
 Analog Output module 82
 Application 230
 Application packages 257
 Applicator 231
 Approvals 254
- B**
 Binary input module 80
 Binary output module 83
- C**
 Cable entries
 Technical data 239
 Cable entry
 Degree of protection 47
 CE mark 10, 254
 Certificates 254
 Certification PROFINET 255
 Checklist
 Post-connection check 48
 Post-installation check 31
 CIP cleaning 244
 Cleaning
 CIP cleaning 224
 Exterior cleaning 224
 Internal cleaning 224
 SIP cleaning 224
 Climate class 244
 Commissioning 87
 Advanced settings 117
 Configuring the measuring instrument 88
 Connecting cable 33
 Connecting the measuring instrument 36
 Connecting the signal cables 36
 Connecting the supply voltage cables 36
- Connection
 see Electrical connection
 Connection cable 32
 Connection preparations 35
 Connection tools 32
 Context menu
 Calling up 58
 Closing 58
 Explanation 58
 Current consumption 238
 Cyclic data transmission 78
- D**
 Date of manufacture 16, 17
 Declaration of Conformity 10
 Defining the access code 139, 140
 Degree of protection 47, 244
 Density adjustment 120
 Design
 Operating menu 50
 Design fundamentals
 Measurement error 242
 Repeatability 242
 Device components 14
 Device description files 76
 Device locking, status 142
 Device master file
 GSD 76
 Device name
 Sensor 17
 Transmitter 16
 Device repair 225
 Device revision 76
 Device type ID 76
 Device Viewer 225
 DeviceCare 74
 Device description file 76
 Diagnosis
 Symbols 159
 Diagnostic behavior
 Explanation 160
 Symbols 160
 Diagnostic information
 Design, description 160, 163
 DeviceCare 162
 FieldCare 162
 Light emitting diodes 157
 Local display 159
 Overview 167
 Remedial measures 167
 Web browser 161
 Diagnostic message 159
 Diagnostics list 218
 DIP switch
 see Write protection switch
 Direct access 60

- Disabling write protection 139
- Display
 - see Local display
- Display and operating module DKX001 250
- Display area
 - For operational display 53
 - In the navigation view 54
- Display values
 - For locking status 142
- Displaying the measured value history 150
- Disposal 226
- Document
 - Function 6
 - Symbols 6
- Document function 6
- Down pipe 21
- E**
- Editing view 56
 - Input screen 57
 - Using operating elements 56, 57
- EHEDG-tested 255
- Electrical connection
 - Degree of protection 47
 - Measuring instrument 32
 - Operating tools
 - Via PROFINET network 70
 - Via service interface (CDI-RJ45) 71
 - Via WLAN interface 72
 - RSLogix 5000 70
 - Web server 71
 - WLAN interface 72
- Electromagnetic compatibility 245
- Electronics module 14
- Enabling write protection 139
- Enabling/disabling the keypad lock 63
- Endress+Hauser services
 - Maintenance 224
 - Repair 225
- Error messages
 - see Diagnostic messages
- Event logbook 219
- Events list 219
- Extended order code
 - Sensor 17
 - Transmitter 16
- Exterior cleaning 224
- F**
- FDA 255
- Field of application
 - Residual risks 10
- FieldCare 73
 - Device description file 76
 - Establishing a connection 73
 - Function 73
 - User interface 74
- Filtering the event logbook 220
- Firmware
 - Release date 76
 - Version 76
- Firmware history 223
- Flow direction 22, 28
- Flow limit 246
- Food Contact Materials Regulation 255
- Functions
 - see Parameters
- G**
- Galvanic isolation 237
- Gas Fraction Handler 153
- H**
- Hardware write protection 140
- Help text
 - Calling up 61
 - Closing 61
 - Explanation 61
- HistoROM 134
- Hygienic compatibility 255
- I**
- Identifying the measuring instrument 15
- Incoming acceptance 15
- Indication
 - Current diagnostic event 218
 - Previous diagnostic event 218
- Influence
 - Ambient temperature 241
 - Medium pressure 242
 - Medium temperature 242
 - Process density 242
- Information about this document 6
- Inlet runs 22
- Input variables 231
- Inspection
 - Connection 48
 - Installation 31
 - Received goods 15
- Installation dimensions 22
- Installation point 21
- Intended use 9
- Internal cleaning 224, 244
- L**
- Languages, operation options 250
- Line recorder 150
- Local display 250
 - Navigation view 54
 - see Diagnostic message
 - see In alarm condition
 - see Operational display
 - Text editor 56
- Low flow cut off 237
- M**
- Main electronics module 14
- Maintenance work 224

- Managing the device configuration 134
 - Manufacturer ID 76
 - Mass module 80
 - Mass Totalizer Control module 80
 - Materials 247
 - Maximum measurement error 239
 - Measured variables
 - see Process variables
 - Measurement accuracy 239
 - Measuring and test equipment 224
 - Measuring device
 - Conversion 225
 - Disposal 226
 - Mounting the sensor 28
 - Preparing for electrical connection 35
 - Removing 226
 - Repairs 225
 - Structure 14
 - Switching on 87
 - Measuring instrument
 - Configuring 88
 - Preparing for mounting 28
 - Measuring principle 230
 - Measuring range
 - For gases 231
 - For liquids 231
 - Measuring range, recommended 246
 - Measuring system 230
 - Mechanical load 244
 - Medium pressure
 - Influence 242
 - Medium temperature
 - Influence 242
 - Menu
 - Diagnostics 218
 - Setup 89
 - Menus
 - For measuring instrument configuration 88
 - For specific settings 117
 - Module
 - Analog output 82
 - Binary input 80
 - Binary output 83
 - Mass 80
 - Mass Totalizer Control 80
 - Totalizer
 - Totalizer 81
 - Totalizer Control 81
 - Mounting 21
 - Mounting dimensions
 - see Installation dimensions
 - Mounting preparations 28
 - Mounting requirements
 - Down pipe 21
 - Inlet and outlet runs 22
 - Installation dimensions 22
 - Installation point 21
 - Orientation 22
 - Rupture disk 25
 - Sensor heating 24
 - Static pressure 23
 - Thermal insulation 23
 - Vibrations 24
 - Mounting tool 28
- N**
- Nameplate
 - Sensor 17
 - Transmitter 16
 - Navigation path (navigation view) 54
 - Navigation view
 - In the submenu 54
 - In the wizard 54
 - Netilion 224
 - Numeric editor 56
- O**
- Onsite display
 - Numeric editor 56
 - Operable flow range 231
 - Operating elements 58, 160
 - Operating height 244
 - Operating keys
 - see Operating elements
 - Operating menu
 - Design 50
 - Menus, submenus 50
 - Submenus and user roles 51
 - Operating philosophy 51
 - Operation 142
 - Operation options 49
 - Operational display 52
 - Operational safety 10
 - Order code 16, 17
 - Orientation (vertical, horizontal) 22
 - Outlet runs 22
 - Output signal 233
 - Output variables 233
- P**
- Packaging disposal 20
 - Parameter
 - Changing 61
 - Entering values or text 61
 - Parameter settings
 - Administration (Submenu) 136
 - Advanced setup (Submenu) 118
 - Communication (Submenu) 89
 - Configuration backup (Submenu) 134
 - Corrected volume flow calculation (Submenu) 119
 - Current input 96
 - Current input (Wizard) 96
 - Current input 1 to n (Submenu) 146
 - Current output 98
 - Current output (Wizard) 98
 - Data logging (Submenu) 150
 - Define access code (Wizard) 135
 - Density adjustment (Wizard) 121

Device information (Submenu)	222
Diagnostics (Menu)	218
Display (Submenu)	128
Display (Wizard)	112
I/O configuration	95
I/O configuration (Submenu)	95
Low flow cut off (Wizard)	115
Measured variables (Submenu)	143
Measurement mode (Submenu)	154
Medium index (Submenu)	154
Medium selection (Wizard)	93
Partially filled pipe detection (Wizard)	116
Pulse/frequency/switch output	102
Pulse/frequency/switch output (Wizard)	
.	102, 104, 107
Pulse/frequency/switch output 1 to n (Submenu)	148
Relay output	109
Relay output 1 to n (Submenu)	148
Relay output 1 to n (Wizard)	109
Reset access code (Submenu)	136
Sensor adjustment (Submenu)	120
Setup (Menu)	89
Simulation (Submenu)	136
Status input	97
Status input 1 to n (Submenu)	147
Status input 1 to n (Wizard)	97
System units (Submenu)	90
Totalizer (Submenu)	145
Totalizer 1 to n (Submenu)	126
Totalizer handling (Submenu)	149
Value current output 1 to n (Submenu)	147
Volume flow (Submenu)	95
Web server (Submenu)	69
WLAN settings (Wizard)	131
Zero adjustment (Wizard)	125
Zero verification (Wizard)	124
Performance characteristics	239
Performing density adjustment	121
Post-connection check	87
Post-connection check (checklist)	48
Post-installation check	87
Post-installation check (checklist)	31
Potential equalization	41
Power consumption	238
Power supply failure	238
Pressure loss	246
Pressure-temperature ratings	245
Process connections	249
Process density	
Influence	242
Process variables	
Calculated	231
Measured	231
Product safety	10
Protecting parameter settings	139
R	
Radio approval	255
Read access	62
Reading measured values	142
Recalibration	224
Reference operating conditions	239
Registered trademarks	8
Remedial measures	
Calling up	161
Closing	161
Remote operation	251
Repair	225
Notes	225
Repair of a device	225
Repeatability	241
Replacement	
Device components	225
Requirements for personnel	9
Response time	241
Return	225
Rupture disk	
Safety instructions	25
Triggering pressure	245
S	
Safety	9
Sensor	
Installing	28
Sensor heating	24
Sensor housing	245
Serial number	16, 17
Setting the operating language	87
Settings	
Adapting the measuring device to the process	
conditions	149
Administration	135
Advanced display configurations	128
Analog Input	95
Communication interface	89
Current input	96
Current output	98
I/O configuration	95
Local display	112
Low flow cut off	115
Managing the device configuration	134
Medium	93
Operating language	87
Partially filled pipe detection	116
Pulse output	102
Pulse/frequency/switch output	102, 104
Relay output	109
Resetting the device	221
Resetting the totalizer	149
Sensor adjustment	120
Simulation	136
Status input	97
Switch output	107
System units	90
Tag name	89
Totalizer	126
Totalizer reset	149
WLAN	131

- Shock and vibration resistance 244
- Signal on alarm 235
- SIP cleaning 244
- Software release 76
- Spare part 225
- Spare parts 225
- Special connection instructions 42
- Special mounting instructions
 - Hygienic compatibility 25
- Standards and guidelines 256
- Static pressure 23
- Status area
 - For operational display 52
 - In the navigation view 54
- Status signals 159, 162
- Storage concept 253
- Storage conditions 19
- Storage temperature 19
- Storage temperature range 243
- Structure
 - Measuring device 14
- Submenu
 - Administration 135, 136
 - Advanced setup 117, 118
 - Analog inputs 95
 - Calculated values 118
 - Communication 89
 - Concentration 133
 - Configuration backup 134
 - Corrected volume flow calculation 119
 - Current input 1 to n 146
 - Data logging 150
 - Device information 222
 - Display 128
 - Events list 219
 - Heartbeat setup 133
 - I/O configuration 95
 - Input values 146
 - Measured values 142
 - Measured variables 143
 - Measurement mode 154
 - Medium index 154
 - Output values 147
 - Overview 51
 - Petroleum 133
 - Process variables 118
 - Pulse/frequency/switch output 1 to n 148
 - Relay output 1 to n 148
 - Reset access code 136
 - Sensor adjustment 120
 - Simulation 136
 - Status input 1 to n 147
 - System units 90
 - Totalizer 145
 - Totalizer 1 to n 126
 - Totalizer handling 149
 - Value current output 1 to n 147
 - Viscosity 133
 - Volume flow 95
 - Web server 69
 - Supply voltage 238
 - Surface roughness 249
 - Switch output 235
 - Symbols
 - Controlling data entries 57
 - For communication 52
 - For diagnostic behavior 52
 - For locking 52
 - For measured variable 53
 - For measurement channel number 53
 - For menus 54
 - For parameters 54
 - For status signal 52
 - For submenu 54
 - For wizards 54
 - In the status area of the local display 52
 - Input screen 57
 - Operating elements 56
 - System design
 - Measuring system 230
 - see Measuring device design
 - System integration 76
 - System redundancy S2 86

T

 - Technical data, overview 230
 - Temperature range
 - Ambient temperature range for display 250
 - Medium temperature 245
 - Storage temperature 19
 - Terminal assignment 35
 - Terminals 239
 - Tests and certificates 255
 - Text editor 56
 - Thermal insulation 23
 - Tool
 - For mounting 28
 - Transport 19
 - Tool tip
 - see Help text
 - Tools
 - Electrical connection 32
 - Totalizer
 - Assign process variable 145
 - Configuring 126
 - Totalizer Control module 81
 - Totalizer module 81
 - Transmitter
 - Turning the display module 30
 - Turning the housing 29
 - Transporting the measuring device 19
 - Troubleshooting
 - General 155
 - Turning the display module 30
 - Turning the electronics housing
 - see Turning the transmitter housing
 - Turning the transmitter housing 29

U

- UKCA marking 254
- Use of measuring device
 - Borderline cases 9
 - Incorrect use 9
- Use of measuring instrument
 - see Intended use
- User roles 51

V

- Version data for the device 76
- Vibrations 24

W

- W@M Device Viewer 15
- Weight
 - SI units 246
 - Transport (notes) 19
 - US units 247
- Wizard
 - Current input 96
 - Current output 98
 - Define access code 135
 - Density adjustment 121
 - Display 112
 - Low flow cut off 115
 - Medium selection 93
 - Partially filled pipe detection 116
 - Pulse/frequency/switch output 102, 104, 107
 - Relay output 1 to n 109
 - Status input 1 to n 97
 - WLAN settings 131
 - Zero adjustment 125
 - Zero verification 124
- WLAN settings 131
- Workplace safety 10
- Write access 62
- Write protection
 - Via access code 139
 - Via write protection switch 140
- Write protection switch 140



71675248

www.addresses.endress.com
