

# Technical Information

## Proline Promass F 100

Coriolis flowmeter



The flowmeter with premium accuracy, robustness and an ultra-compact transmitter

### Application

Measuring principle operates independently of physical fluid properties such as viscosity or density

#### *Device properties*

- Mass/volume flow: measurement error  $\pm 0.05\%$
- Pressure rating of secondary containment up to 40 bar (580 psi)
- Nominal diameter: DN 8 to 250 ( $\frac{3}{8}$  to 10")
- Robust, ultra-compact transmitter housing
- Highest degree of protection: IP69
- Local display available

### Your benefits

- Highest process safety – immune to fluctuating and harsh environments
- Fewer process measuring points – multivariable measurement (flow, density, temperature)
- Space-saving installation – no in-/outlet run needs
- Space-saving transmitter – full functionality on smallest footprint
- Time-saving local operation without additional software and hardware – integrated web server
- Integrated verification – Heartbeat Technology

## Table of contents





<b>About this document</b> . . . . .	<b>4</b>	Degree of protection . . . . .	49
Symbols . . . . .	4	Shock and vibration resistance . . . . .	49
<b>Function and system design</b> . . . . .	<b>5</b>	Internal cleaning . . . . .	50
Measuring principle . . . . .	5	Electromagnetic compatibility (EMC) . . . . .	50
Measuring system . . . . .	7	<b>Process</b> . . . . .	<b>50</b>
Equipment architecture . . . . .	8	Medium temperature range . . . . .	50
Reliability . . . . .	8	Pressure-temperature ratings . . . . .	50
<b>Input</b> . . . . .	<b>9</b>	Sensor housing . . . . .	55
Measured variable . . . . .	9	Rupture disk . . . . .	56
Measuring range . . . . .	9	Flow limit . . . . .	57
Operable flow range . . . . .	9	Pressure loss . . . . .	57
Input signal . . . . .	10	Static pressure . . . . .	57
<b>Output</b> . . . . .	<b>10</b>	Thermal insulation . . . . .	57
Output signal . . . . .	10	Heating . . . . .	58
Signal on alarm . . . . .	12	Vibrations . . . . .	58
Ex connection data . . . . .	13	<b>Mechanical construction</b> . . . . .	<b>59</b>
Low flow cut off . . . . .	14	Dimensions in SI units . . . . .	59
Protocol-specific data . . . . .	14	Dimensions in US units . . . . .	78
<b>Power supply</b> . . . . .	<b>24</b>	Weight . . . . .	87
Terminal assignment . . . . .	24	Materials . . . . .	88
Pin assignment, device plug . . . . .	31	Process connections . . . . .	90
Supply voltage . . . . .	34	Surface roughness . . . . .	90
Power consumption . . . . .	34	<b>Operability</b> . . . . .	<b>91</b>
Current consumption . . . . .	34	Operating concept . . . . .	91
Device fuse . . . . .	34	Local display . . . . .	91
Power supply failure . . . . .	35	Remote operation . . . . .	91
Electrical connection . . . . .	35	Service interface . . . . .	94
Potential equalization . . . . .	39	<b>Certificates and approvals</b> . . . . .	<b>96</b>
Terminals . . . . .	39	CE mark . . . . .	96
Cable entries . . . . .	40	UKCA marking . . . . .	96
Cable specification . . . . .	40	RCM marking . . . . .	96
<b>Performance characteristics</b> . . . . .	<b>41</b>	Ex approval . . . . .	96
Reference operating conditions . . . . .	41	Hygienic compatibility . . . . .	97
Maximum measurement error . . . . .	41	Pharmaceutical compatibility . . . . .	97
Repeatability . . . . .	43	HART certification . . . . .	97
Response time . . . . .	43	Certification PROFIBUS . . . . .	98
Influence of ambient temperature . . . . .	43	Certification PROFINET . . . . .	98
Influence of medium temperature . . . . .	43	EtherNet/IP certification . . . . .	98
Influence of medium pressure . . . . .	44	Modbus RS485 certification . . . . .	98
Design fundamentals . . . . .	45	Pressure Equipment Directive . . . . .	98
<b>Mounting</b> . . . . .	<b>46</b>	External standards and guidelines . . . . .	98
Installation point . . . . .	46	<b>Ordering information</b> . . . . .	<b>99</b>
Orientation . . . . .	47	<b>Application packages</b> . . . . .	<b>99</b>
Inlet and outlet runs . . . . .	47	Heartbeat Technology . . . . .	99
Special mounting instructions . . . . .	47	Concentration measurement . . . . .	100
Installing the Safety Barrier Promass 100 . . . . .	49	Special density . . . . .	100
<b>Environment</b> . . . . .	<b>49</b>	Extended density . . . . .	100
Ambient temperature range . . . . .	49	<b>Accessories</b> . . . . .	<b>101</b>
Storage temperature . . . . .	49	Device-specific accessories . . . . .	101
Climate class . . . . .	49	Communication-specific accessories . . . . .	101

Service-specific accessories . . . . .	102
System components . . . . .	102
<b>Supplementary documentation . . . . .</b>	<b>103</b>
Standard documentation . . . . .	103
Supplementary device-dependent documentation . . . . .	103
<b>Registered trademarks . . . . .</b>	<b>104</b>









## About this document

### Symbols



#### Electrical symbols

Symbol	Meaning
	Direct current
	Alternating current
	Direct current and alternating current
	<b>Ground connection</b> A grounded terminal which, as far as the operator is concerned, is grounded via a grounding system.
	<b>Potential equalization connection (PE: protective earth)</b> Ground terminals that must be connected to ground prior to establishing any other connections.  The ground terminals are located on the interior and exterior of the device: <ul style="list-style-type: none"> <li>▪ Interior ground terminal: potential equalization is connected to the supply network.</li> <li>▪ Exterior ground terminal: device is connected to the plant grounding system.</li> </ul>

#### Symbols for certain types of information

Symbol	Meaning
	<b>Permitted</b> Procedures, processes or actions that are permitted.
	<b>Preferred</b> Procedures, processes or actions that are preferred.
	<b>Forbidden</b> Procedures, processes or actions that are forbidden.
	<b>Tip</b> Indicates additional information.
	Reference to documentation
	Reference to page
	Reference to graphic
	Visual inspection

#### Symbols in graphics

Symbol	Meaning
1, 2, 3, ...	Item numbers
<b>1.</b> , <b>2.</b> , <b>3.</b> , ...	Series of steps
A, B, C, ...	Views
A-A, B-B, C-C, ...	Sections
	Hazardous area
	Safe area (non-hazardous area)
	Flow direction

## Function and system design

### Measuring principle

The measuring principle is based on the controlled generation of Coriolis forces. These forces are always present in a system when both translational and rotational movements are superimposed.

$$F_c = 2 \cdot \Delta m (v \cdot \omega)$$

$F_c$  = Coriolis force

$\Delta m$  = moving mass

$\omega$  = rotational velocity

$v$  = radial velocity in rotating or oscillating system

The amplitude of the Coriolis force depends on the moving mass  $\Delta m$ , its velocity  $v$  in the system and thus on the mass flow. Instead of a constant rotational velocity  $\omega$ , the sensor uses oscillation.

In the sensor, two parallel measuring tubes containing flowing fluid oscillate in antiphase, acting like a tuning fork. The Coriolis forces produced at the measuring tubes cause a phase shift in the tube oscillations (see illustration):

- At zero flow (when the fluid is at a standstill) the two tubes oscillate in phase (1).
- Mass flow causes deceleration of the oscillation at the inlet of the tubes (2) and acceleration at the outlet (3).

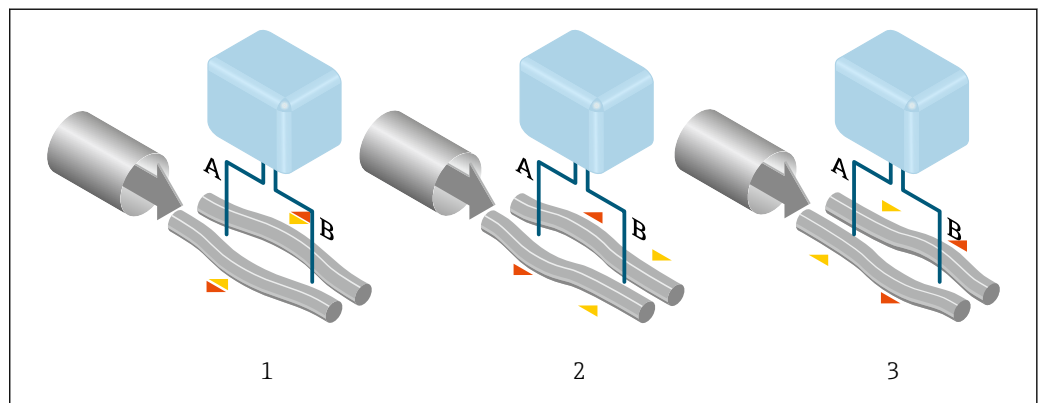

A0028850

The phase difference (A-B) increases with increasing mass flow. Electrodynamics sensors register the tube oscillations at the inlet and outlet. System balance is ensured by the antiphase oscillation of the two measuring tubes. The measuring principle operates independently of temperature, pressure, viscosity, conductivity and flow profile.

### Density measurement

The measuring tube is continuously excited at its resonance frequency. A change in the mass and thus the density of the oscillating system (comprising measuring tube and fluid) results in a corresponding, automatic adjustment in the oscillation frequency. The resonance frequency is thus a function of the medium density. The microprocessor utilizes this relationship to obtain a density signal.

### Volume measurement

Together with the measured mass flow, this is used to calculate the volume flow.

### Temperature measurement

The temperature of the measuring tube is determined in order to calculate the compensation factor due to temperature effects. This signal corresponds to the process temperature and is also available as an output signal.

### Gas Fraction Handler (GFH)

The Gas Fraction Handler is a Promass software function that improves measurement stability and repeatability. The function continuously checks for the presence of disturbances in single-phase flow, i.e. gas bubbles in liquids or droplets in gas. In the presence of the second phase, flow and density become increasingly unstable. The Gas Fraction Handler function improves measurement stability

with respect to the severity of the disturbances, without any effect under single-phase flow conditions.



The Gas Fraction Handler is only available in device versions with HART, Modbus RS485, PROFINET and PROFINET with Ethernet-APL.



For detailed information on the Gas Fraction Handler, see the Special Documentation for "Gas Fraction Handler"

**Measuring system**

The device consists of a transmitter and a sensor. If a device with Modbus RS485 intrinsically safe is ordered, the Safety Barrier Promass 100 is part of the scope of supply and must be implemented to operate the device.

The device is available as a compact version:  
The transmitter and sensor form a mechanical unit.

**Transmitter**

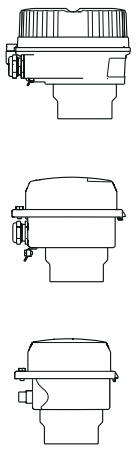
<p><b>Proline 100</b></p>  <p>A0016693</p> <p>A0016694</p> <p>A0016695</p>	<p>Device versions and materials:</p> <ul style="list-style-type: none"> <li>▪ Compact, aluminum, coated: Aluminum, AlSi10Mg, coated</li> <li>▪ Compact, hygienic, stainless:             <ul style="list-style-type: none"> <li>▪ Hygienic version, stainless steel 1.4301 (304)</li> <li>▪ Optional: order code for "Sensor feature", option <b>CC</b></li> <li>▪ Hygienic version, for maximum corrosion resistance: stainless steel 1.4404 (316L)</li> </ul> </li> <li>▪ Ultra-compact, hygienic, stainless:             <ul style="list-style-type: none"> <li>▪ Hygienic version, stainless steel 1.4301 (304)</li> <li>▪ Optional: order code for "Sensor feature", option <b>CC</b></li> <li>▪ Hygienic version, for maximum corrosion resistance: stainless steel 1.4404 (316L)</li> </ul> </li> </ul> <p>Configuration:</p> <ul style="list-style-type: none"> <li>▪ Via operating tools (e.g. FieldCare, DeviceCare)</li> <li>▪ Also for device version with local display (LCD): Via web browser (e.g. Microsoft Internet Explorer)</li> <li>▪ Also for device version with 4-20 mA HART, pulse/frequency/switch output:             <ul style="list-style-type: none"> <li>▪ Via web browser (e.g. Microsoft Internet Explorer)</li> <li>▪ Also for device version with EtherNet/IP output:                 <ul style="list-style-type: none"> <li>▪ Via web browser (e.g. Microsoft Internet Explorer)</li> <li>▪ Via Add-on Profile Level 3 for automation system from Rockwell Automation</li> <li>▪ Via Electronic Data Sheet (EDS)</li> </ul> </li> <li>▪ Also for device version with PROFINET output:                 <ul style="list-style-type: none"> <li>▪ Via web browser (e.g. Microsoft Internet Explorer)</li> <li>▪ Via device master file (GSD)</li> </ul> </li> </ul> </li> </ul>
-------------------------------------------------------------------------------------------------------------------------------------------------------------	------------------------------------------------------------------------------------------------------------------------------------------------------------------------------------------------------------------------------------------------------------------------------------------------------------------------------------------------------------------------------------------------------------------------------------------------------------------------------------------------------------------------------------------------------------------------------------------------------------------------------------------------------------------------------------------------------------------------------------------------------------------------------------------------------------------------------------------------------------------------------------------------------------------------------------------------------------------------------------------------------------------------------------------------------------------------------------------------------------------------------------------------------------------------------------------------------------------------------------------------------------------------------------------------------------------------------------------------------------------------------------------------------------------------------------------------------------------------------------------------------------------------------------------------------------------------------------------------------------------------------------------------------------------------------------------------------------------------------------------------------------------------------------------------------------------

**Sensor**

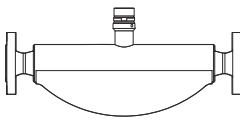
<p><b>Promass F</b></p>  <p>A0016507</p>	<ul style="list-style-type: none"> <li>▪ Bent dual-tube system</li> <li>▪ Excellent performance across a wide range of applications</li> <li>▪ Simultaneous measurement of flow, volume flow, density and temperature (multivariable)</li> <li>▪ Immune to process influences</li> <li>▪ Nominal diameter range: DN 8 to 250 (3/8 to 10")</li> <li>▪ Materials:             <ul style="list-style-type: none"> <li>▪ Sensor: stainless steel, 1.4301 (304); optional 1.4404 (316/316L)</li> <li>▪ Measuring tubes: stainless steel, 1.4539 (904L); 1.4404 (316/316L); Alloy C22, 2.4602 (UNS N06022)</li> <li>▪ Process connections: stainless steel, 1.4404 (316/316L); 1.4301 (304); Alloy C22, 2.4602 (UNS N06022)</li> </ul> </li> </ul>
-----------------------------------------------------------------------------------------------------------------------------	----------------------------------------------------------------------------------------------------------------------------------------------------------------------------------------------------------------------------------------------------------------------------------------------------------------------------------------------------------------------------------------------------------------------------------------------------------------------------------------------------------------------------------------------------------------------------------------------------------------------------------------------------------------------------------------------------------------------------------------------

**Safety Barrier Promass 100**

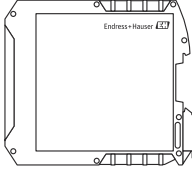
 <p>A0016763</p>	<ul style="list-style-type: none"> <li>▪ Dual-channel safety barrier for installation in non-hazardous locations or zone 2/div. 2:             <ul style="list-style-type: none"> <li>▪ Channel 1: DC 24 V power supply</li> <li>▪ Channel 2: Modbus RS485</li> </ul> </li> <li>▪ In addition to current, voltage and power limitation, it offers galvanic isolation of circuits for explosion protection.</li> <li>▪ Easy top-hat rail mounting (DIN 35 mm) for installation in control cabinets</li> </ul>
-----------------------------------------------------------------------------------------------------	--------------------------------------------------------------------------------------------------------------------------------------------------------------------------------------------------------------------------------------------------------------------------------------------------------------------------------------------------------------------------------------------------------------------------------------------------------------------------------------------------------------

## Equipment architecture

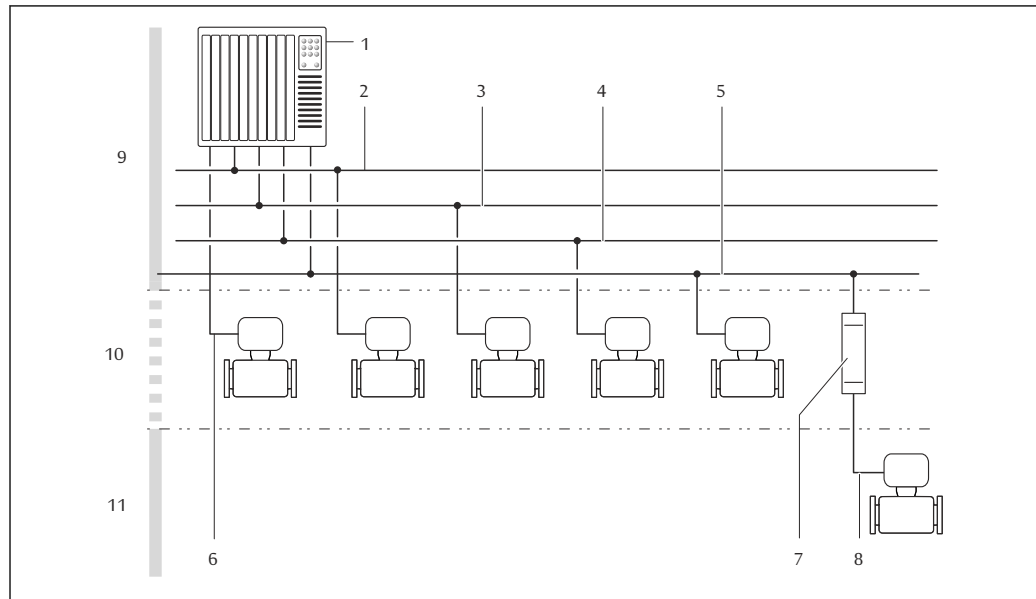

A0016779

1 Possibilities for integrating measuring devices into a system

- 1 Control system (e.g. PLC)
- 2 EtherNet/IP
- 3 PROFIBUS DP
- 4 PROFINET
- 5 Modbus RS485
- 6 4-20 mA HART, pulse/frequency/switch output
- 7 Safety Barrier Promass 100
- 8 Modbus RS485 intrinsically safe
- 9 Non-hazardous area
- 10 Non-hazardous area and Zone 2/Div. 2
- 11 Hazardous area and Zone 1/Div. 1

## Reliability

## IT security

Our warranty is valid only if the product is installed and used as described in the Operating Instructions. The product is equipped with security mechanisms to protect it against any inadvertent changes to the settings.

IT security measures, which provide additional protection for the product and associated data transfer, must be implemented by the operators themselves in line with their security standards.



# Input

**Measured variable**

**Direct measured variables**

- Mass flow
- Density
- Temperature

**Calculated measured variables**

- Volume flow
- Corrected volume flow
- Reference density

**Measuring range**

**Measuring range for liquids**



DN		Measuring range full scale values $\dot{m}_{\min(F)}$ to $\dot{m}_{\max(F)}$	
[mm]	[in]	[kg/h]	[lb/min]
8	$\frac{3}{8}$	0 to 2 000	0 to 73.50
15	$\frac{1}{2}$	0 to 6 500	0 to 238.9
25	1	0 to 18 000	0 to 661.5
40	$1\frac{1}{2}$	0 to 45 000	0 to 1 654
50	2	0 to 70 000	0 to 2 573
80	3	0 to 180 000	0 to 6 615
100	4	0 to 350 000	0 to 12 860
150	6	0 to 800 000	0 to 29 400
250	10	0 to 2 200 000	0 to 80 850

**Measuring range for gases**



The full scale value depends on the density and the sound velocity of the gas used. The full scale value can be calculated with the following formulas:

$$\dot{m}_{\max(G)} = (\rho_G \cdot c_G / m) \cdot d_i^2 \cdot (\pi/4) \cdot 3600 \cdot n$$

$\dot{m}_{\max(G)}$	Maximum full scale value for gas [kg/h]
$\rho_G$	Gas density in [kg/m <sup>3</sup> ] at operating conditions
$c_G$	Sound velocity (gas) [m/s]
$d_i$	Measuring tube internal diameter [m]
$\pi$	Pi
$n = 2$	Number of measuring tubes
$m = 2$	For all gases except pure H <sub>2</sub> and He gas
$m = 3$	For pure H <sub>2</sub> and He gas

 To calculate the measuring range, use the *Applicator* sizing tool →  102

**Recommended measuring range**

 Flow limit →  57

**Operable flow range**

Over 1000 : 1.



Flow rates above the preset full scale value do not override the electronics unit, with the result that the totalizer values are registered correctly.

## Input signal

### External measured values

To increase the measurement accuracy of certain measured variables or to calculate the corrected volume flow for gases, the automation system can continuously write different measured values to the measuring instrument:

- Operating pressure to increase measurement accuracy (Endress+Hauser recommends the use of a pressure measuring instrument for absolute pressure, e.g. Cerabar M or Cerabar S)
- Medium temperature to increase measurement accuracy (e.g. iTEMP)
- Reference density for calculating the corrected volume flow for gases

 Various pressure transmitters and temperature measuring instruments can be ordered from Endress+Hauser: see "Accessories" section →  102

It is recommended to read in external measured values to calculate the following measured variables:

- Mass flow
- Corrected volume flow

### HART protocol

The measured values are written from the automation system to the measuring device via the HART protocol. The pressure transmitter must support the following protocol-specific functions:

- HART protocol
- Burst mode

### Digital communication

The measured values can be written by the automation system via:

- PROFIBUS DP
- Modbus RS485
- Ethernet/IP
- PROFINET

## Output



### Output signal

#### HART current output

<b>Current output</b>	4-20 mA HART (active)
<b>Maximum output values</b>	<ul style="list-style-type: none"> <li>▪ DC 24 V (no flow)</li> <li>▪ 22.5 mA</li> </ul>
<b>Load</b>	0 to 700 Ω
<b>Resolution</b>	0.38 μA
<b>Damping</b>	Configurable: 0.07 to 999 s
<b>Assignable measured variables</b>	<ul style="list-style-type: none"> <li>▪ Mass flow</li> <li>▪ Volume flow</li> <li>▪ Corrected volume flow</li> <li>▪ Density</li> <li>▪ Reference density</li> <li>▪ Temperature</li> </ul> <p> The range of options increases if the measuring device has one or more application packages.</p>

#### Pulse/frequency/switch output

<b>Function</b>	Can be set to pulse, frequency or switch output
<b>Version</b>	Passive, open collector
<b>Maximum input values</b>	<ul style="list-style-type: none"> <li>▪ DC 30 V</li> <li>▪ 25 mA</li> </ul>

<b>Voltage drop</b>	For 25 mA: ≤ DC 2 V
<b>Pulse output</b>	
<b>Pulse width</b>	Configurable: 0.05 to 2 000 ms
<b>Maximum pulse rate</b>	10 000 Impulse/s
<b>Pulse value</b>	Adjustable
<b>Assignable measured variables</b>	<ul style="list-style-type: none"> <li>▪ Mass flow</li> <li>▪ Volume flow</li> <li>▪ Corrected volume flow</li> </ul>
<b>Frequency output</b>	
<b>Output frequency</b>	Configurable: 0 to 10 000 Hz
<b>Damping</b>	Configurable: 0 to 999 s
<b>Pulse/pause ratio</b>	1:1
<b>Assignable measured variables</b>	<ul style="list-style-type: none"> <li>▪ Mass flow</li> <li>▪ Volume flow</li> <li>▪ Corrected volume flow</li> <li>▪ Density</li> <li>▪ Reference density</li> <li>▪ Temperature</li> </ul> <p> The range of options increases if the measuring device has one or more application packages.</p>
<b>Switch output</b>	
<b>Switching behavior</b>	Binary, conductive or non-conductive
<b>Switching delay</b>	Configurable: 0 to 100 s
<b>Number of switching cycles</b>	Unlimited
<b>Assignable functions</b>	<ul style="list-style-type: none"> <li>▪ Off</li> <li>▪ On</li> <li>▪ Diagnostic behavior</li> <li>▪ Limit value                             <ul style="list-style-type: none"> <li>▪ Mass flow</li> <li>▪ Volume flow</li> <li>▪ Corrected volume flow</li> <li>▪ Density</li> <li>▪ Reference density</li> <li>▪ Temperature</li> <li>▪ Totalizer 1-3</li> </ul> </li> <li>▪ Flow direction monitoring</li> <li>▪ Status                             <ul style="list-style-type: none"> <li>▪ Partially filled pipe detection</li> <li>▪ Low flow cut off</li> </ul> </li> </ul> <p> The range of options increases if the measuring device has one or more application packages.</p>

**PROFIBUS DP**

<b>Signal encoding</b>	NRZ code
<b>Data transfer</b>	9.6 kBaud...12 MBaud
<b>Terminating resistor</b>	Integrated, can be activated via DIP switches

**Modbus RS485**

<b>Physical interface</b>	In accordance with EIA/TIA-485-A standard
<b>Terminating resistor</b>	<ul style="list-style-type: none"> <li>▪ For device version used in non-hazardous areas or Zone 2/Div. 2: integrated and can be activated via DIP switches on the transmitter electronics module</li> <li>▪ For device version used in intrinsically safe areas: integrated and can be activated via DIP switches on the Safety Barrier Promass 100</li> </ul>

**EtherNet/IP**

<b>Standards</b>	In accordance with IEEE 802.3
------------------	-------------------------------

**PROFINET**

<b>Standards</b>	In accordance with IEEE 802.3
------------------	-------------------------------

**Signal on alarm**

Depending on the interface, failure information is displayed as follows:

**Current output 4 to 20 mA**

*4 to 20 mA*

<b>Failure mode</b>	Choose from: <ul style="list-style-type: none"> <li>▪ 4 to 20 mA in accordance with NAMUR recommendation NE 43</li> <li>▪ 4 to 20 mA in accordance with US</li> <li>▪ Min. value: 3.59 mA</li> <li>▪ Max. value: 22.5 mA</li> <li>▪ Definable value between: 3.59 to 22.5 mA</li> <li>▪ Actual value</li> <li>▪ Last valid value</li> </ul>
---------------------	---------------------------------------------------------------------------------------------------------------------------------------------------------------------------------------------------------------------------------------------------------------------------------------------------------------------------------------------

**Pulse/frequency/switch output**

<b>Pulse output</b>	
<b>Fault mode</b>	Choose from: <ul style="list-style-type: none"> <li>▪ Actual value</li> <li>▪ No pulses</li> </ul>
<b>Frequency output</b>	
<b>Fault mode</b>	Choose from: <ul style="list-style-type: none"> <li>▪ Actual value</li> <li>▪ 0 Hz</li> <li>▪ Definable value between: 0 to 12 500 Hz</li> </ul>
<b>Switch output</b>	
<b>Fault mode</b>	Choose from: <ul style="list-style-type: none"> <li>▪ Current status</li> <li>▪ Open</li> <li>▪ Closed</li> </ul>

**PROFIBUS DP**

<b>Status and alarm messages</b>	Diagnostics in accordance with PROFIBUS PA Profile 3.02
----------------------------------	---------------------------------------------------------

**Modbus RS485**

<b>Failure mode</b>	Choose from: <ul style="list-style-type: none"> <li>▪ NaN value instead of current value</li> <li>▪ Last valid value</li> </ul>
---------------------	---------------------------------------------------------------------------------------------------------------------------------

**EtherNet/IP**

<b>Device diagnostics</b>	Device condition can be read out in Input Assembly
---------------------------	----------------------------------------------------

**PROFINET**

<b>Device diagnostics</b>	According to "Application Layer protocol for decentralized periphery", Version 2.3
---------------------------	------------------------------------------------------------------------------------

**Local display**



<b>Plain text display</b>	With information on cause and remedial measures
<b>Backlight</b>	Red backlighting indicates a device error.

 Status signal as per NAMUR recommendation NE 107

**Interface/protocol**

- Via digital communication:
  - HART protocol
  - PROFIBUS DP
  - Modbus RS485
  - EtherNet/IP
  - PROFINET
- Via service interface  
CDI-RJ45 service interface

<b>Plain text display</b>	With information on cause and remedial measures
---------------------------	-------------------------------------------------

 Additional information on remote operation →  91

**Web browser**

<b>Plain text display</b>	With information on cause and remedial measures
---------------------------	-------------------------------------------------

**Light emitting diodes (LED)**

<b>Status information</b>	Status indicated by various light emitting diodes The following information is displayed depending on the device version: <ul style="list-style-type: none"> <li>▪ Supply voltage active</li> <li>▪ Data transmission active</li> <li>▪ Device alarm/error has occurred</li> <li>▪ EtherNet/IP network available</li> <li>▪ EtherNet/IP connection established</li> <li>▪ PROFINET network available</li> <li>▪ PROFINET connection established</li> <li>▪ PROFINET blinking feature</li> </ul>
---------------------------	----------------------------------------------------------------------------------------------------------------------------------------------------------------------------------------------------------------------------------------------------------------------------------------------------------------------------------------------------------------------------------------------------------------------------------------------------------------------------------------------------

**Ex connection data**

These values only apply for the following device version:  
Order code for "Output", option M "Modbus RS485", for use in intrinsically safe areas

## Safety Barrier Promass 100

### Safety-related values

Terminal numbers			
Supply voltage		Signal transmission	
2 (L-)	1 (L+)	26 (B)	27 (A)
$U_{\text{nom}} = \text{DC } 24 \text{ V}$ $U_{\text{max}} = \text{AC } 260 \text{ V}$		$U_{\text{nom}} = \text{DC } 5 \text{ V}$ $U_{\text{max}} = \text{AC } 260 \text{ V}$	

### Intrinsically safe values

Terminal numbers			
Supply voltage		Signal transmission	
20 (L-)	10 (L+)	62 (B)	72 (A)
$U_o = 16.24 \text{ V}$ $I_o = 623 \text{ mA}$ $P_o = 2.45 \text{ W}$ With IIC <sup>1)</sup> : $L_o = 92.8 \mu\text{H}$ , $C_o = 0.433 \mu\text{F}$ , $L_o/R_o = 14.6 \mu\text{H}/\Omega$ With IIB: $L_o = 372 \mu\text{H}$ , $C_o = 2.57 \mu\text{F}$ , $L_o/R_o = 58.3 \mu\text{H}/\Omega$			
 For an overview and for information on the interdependencies between the gas group - sensor - nominal diameter, see the "Safety Instructions" (XA) document for the measuring device			

1) The gas group depends on the sensor and nominal diameter ff.

## Transmitter

### Intrinsically safe values

Order code "Approval"	Terminal numbers			
	Supply voltage		Signal transmission	
	20 (L-)	10 (L+)	62 (B)	72 (A)
<ul style="list-style-type: none"> <li>▪ Option <b>BM</b>: ATEX II2G + IECEx Z1 Ex ia, II2D Ex tb</li> <li>▪ Option <b>BO</b>: ATEX II1/2G + IECEx Z0/Z1 Ex ia, II2D</li> <li>▪ Option <b>BQ</b>: ATEX II1/2G + IECEx Z0/Z1 Ex ia</li> <li>▪ Option <b>BU</b>: ATEX II2G + IECEx Z1 Ex ia</li> <li>▪ Option <b>C2</b>: CSA C/US IS Cl. I, II, III Div. 1</li> <li>▪ Option <b>85</b>: ATEX II2G + IECEx Z1 Ex ia + CSA C/US IS Cl. I, II, III Div. 1</li> </ul>	$U_i = 16.24 \text{ V}$ $I_i = 623 \text{ mA}$ $P_i = 2.45 \text{ W}$ $L_i = 0 \mu\text{H}$ $C_i = 6 \text{ nF}$			
 For an overview and for information on the interdependencies between the gas group - sensor - nominal diameter, see the "Safety Instructions" (XA) document for the measuring device				

## Low flow cut off

The switch points for low flow cut off are user-selectable.

## Protocol-specific data

### HART

Manufacturer ID	0x11
Device type ID	0x4A
HART protocol revision	7
Device description files (DTM, DD)	Information and files under: <a href="http://www.endress.com">www.endress.com</a>
HART load	Min. 250 $\Omega$

<p><b>Dynamic variables</b></p>	<p>Read out the dynamic variables: HART command 3 The measured variables can be freely assigned to the dynamic variables.</p> <p><b>Measured variables for PV (primary dynamic variable)</b></p> <ul style="list-style-type: none"> <li>▪ Mass flow</li> <li>▪ Volume flow</li> <li>▪ Corrected volume flow</li> <li>▪ Density</li> <li>▪ Reference density</li> <li>▪ Temperature</li> </ul> <p><b>Measured variables for SV, TV, QV (secondary, tertiary and quaternary dynamic variable)</b></p> <ul style="list-style-type: none"> <li>▪ Mass flow</li> <li>▪ Volume flow</li> <li>▪ Corrected volume flow</li> <li>▪ Density</li> <li>▪ Reference density</li> <li>▪ Temperature</li> <li>▪ Totalizer 1</li> <li>▪ Totalizer 2</li> <li>▪ Totalizer 3</li> </ul> <p> The range of options increases if the measuring device has one or more application packages.</p> <p><b>Heartbeat Technology application package</b> Additional measured variables are available with the Heartbeat Technology application package:</p> <ul style="list-style-type: none"> <li>▪ Carrier pipe temperature</li> <li>▪ Oscillation amplitude 0</li> </ul>
<p><b>Device variables</b></p>	<p>Read out the device variables: HART command 9 The device variables are permanently assigned.</p> <p>A maximum of 8 device variables can be transmitted:</p> <ul style="list-style-type: none"> <li>▪ 0 = mass flow</li> <li>▪ 1 = volume flow</li> <li>▪ 2 = corrected volume flow</li> <li>▪ 3 = density</li> <li>▪ 4 = reference density</li> <li>▪ 5 = temperature</li> <li>▪ 6 = totalizer 1</li> <li>▪ 7 = totalizer 2</li> <li>▪ 8 = totalizer 3</li> <li>▪ 13 = target mass flow</li> <li>▪ 14 = carrier mass flow</li> <li>▪ 15 = concentration</li> </ul>

**PROFIBUS DP**



<p><b>Manufacturer ID</b></p>	<p>0x11</p>
<p><b>Ident number</b></p>	<p>0x1561</p>
<p><b>Profile version</b></p>	<p>3.02</p>
<p><b>Device description files (GSD, DTM, DD)</b></p>	<p>Information and files available at:</p> <ul style="list-style-type: none"> <li>▪ <a href="https://www.endress.com/download">https://www.endress.com/download</a> On the device product page: PRODUCTS → Product Finder → Links</li> <li>▪ <a href="https://www.profibus.com">https://www.profibus.com</a></li> </ul>

<b>Output values</b> (from measuring instrument to automation system)	<b>Analog input 1 to 8</b> <ul style="list-style-type: none"> <li>▪ Mass flow</li> <li>▪ Volume flow</li> <li>▪ Corrected volume flow</li> <li>▪ Target mass flow</li> <li>▪ Carrier mass flow</li> <li>▪ Density</li> <li>▪ Reference density</li> <li>▪ Concentration</li> <li>▪ Temperature</li> <li>▪ Carrier pipe temperature</li> <li>▪ Electronics temperature</li> <li>▪ Oscillation frequency</li> <li>▪ Oscillation amplitude</li> <li>▪ Frequency fluctuation</li> <li>▪ Oscillation damping</li> <li>▪ Tube damping fluctuation</li> <li>▪ Signal asymmetry</li> <li>▪ Exciter current</li> </ul> <b>Digital input 1 to 2</b> <ul style="list-style-type: none"> <li>▪ Partially filled pipe detection</li> <li>▪ Low flow cut off</li> </ul> <b>Totalizer 1 to 3</b> <ul style="list-style-type: none"> <li>▪ Mass flow</li> <li>▪ Volume flow</li> <li>▪ Corrected volume flow</li> </ul>
<b>Input values</b> (from automation system to measuring instrument)	<b>Analog output 1 to 3 (fixed assignment)</b> <ul style="list-style-type: none"> <li>▪ Pressure</li> <li>▪ Temperature</li> <li>▪ Reference density</li> </ul> <b>Digital output 1 to 3 (fixed assignment)</b> <ul style="list-style-type: none"> <li>▪ Digital output 1: switch positive zero return on/off</li> <li>▪ Digital output 2: perform zero adjustment</li> <li>▪ Digital output 3: switch switch output on/off</li> </ul> <b>Totalizer 1 to 3</b> <ul style="list-style-type: none"> <li>▪ Totalize</li> <li>▪ Reset and hold</li> <li>▪ Preset and hold</li> <li>▪ Stop</li> <li>▪ Operating mode configuration:             <ul style="list-style-type: none"> <li>▪ Net flow total</li> <li>▪ Forward flow total</li> <li>▪ Reverse flow total</li> </ul> </li> </ul>
<b>Supported functions</b>	<ul style="list-style-type: none"> <li>▪ Identification &amp; maintenance Straightforward device identification on the part of the control system and nameplate</li> <li>▪ PROFIBUS upload/download Reading and writing parameters is up to ten times faster with PROFIBUS upload/download.</li> <li>▪ Condensed status Straightforward and self-explanatory diagnostic information by categorizing diagnostic messages that occur</li> </ul>
<b>Configuration of the device address</b>	<ul style="list-style-type: none"> <li>▪ DIP switches on the I/O electronics module</li> <li>▪ Via operating tools (e.g. FieldCare)</li> </ul>

### Modbus RS485

Protocol	Modbus Applications Protocol Specification V1.1
Device type	Slave
Slave address range	1 to 247
Broadcast address range	0



<b>Function codes</b>	<ul style="list-style-type: none"> <li>▪ 03: Read holding register</li> <li>▪ 04: Read input register</li> <li>▪ 06: Write single registers</li> <li>▪ 08: Diagnostics</li> <li>▪ 16: Write multiple registers</li> <li>▪ 23: Read/write multiple registers</li> </ul>
<b>Broadcast messages</b>	<p>Supported by the following function codes:</p> <ul style="list-style-type: none"> <li>▪ 06: Write single registers</li> <li>▪ 16: Write multiple registers</li> <li>▪ 23: Read/write multiple registers</li> </ul>
<b>Supported baud rate</b>	<ul style="list-style-type: none"> <li>▪ 1 200 BAUD</li> <li>▪ 2 400 BAUD</li> <li>▪ 4 800 BAUD</li> <li>▪ 9 600 BAUD</li> <li>▪ 19 200 BAUD</li> <li>▪ 38 400 BAUD</li> <li>▪ 57 600 BAUD</li> <li>▪ 115 200 BAUD</li> </ul>
<b>Data transfer mode</b>	<ul style="list-style-type: none"> <li>▪ ASCII</li> <li>▪ RTU</li> </ul>
<b>Data access</b>	<p>Each device parameter can be accessed via Modbus RS485.</p> <p> For Modbus register information, see "Description of device parameters" documentation →  103</p>

#### EtherNet/IP

<b>Protocol</b>	<ul style="list-style-type: none"> <li>▪ The CIP Networks Library Volume 1: Common Industrial Protocol</li> <li>▪ The CIP Networks Library Volume 2: Ethernet/IP Adaptation of CIP</li> </ul>
<b>Communication type</b>	<ul style="list-style-type: none"> <li>▪ 10Base-T</li> <li>▪ 100Base-TX</li> </ul>
<b>Device profile</b>	Generic device (product type: 0x2B)
<b>Manufacturer ID</b>	0x49E
<b>Device type ID</b>	0x104A
<b>Baud rates</b>	Automatic <sup>10</sup> / <sub>100</sub> Mbit with half-duplex and full-duplex detection
<b>Polarity</b>	Auto-polarity for automatic correction of crossed TxD and RxD pairs
<b>Supported CIP connections</b>	Max. 3 connections
<b>Explicit connections</b>	Max. 6 connections
<b>I/O connections</b>	Max. 6 connections (scanner)
<b>Configuration options for measuring instrument</b>	<ul style="list-style-type: none"> <li>▪ DIP switches on the electronics module for IP addressing</li> <li>▪ Manufacturer-specific software (FieldCare)</li> <li>▪ Add-on Profile Level 3 for Rockwell Automation control systems</li> <li>▪ Web browser</li> <li>▪ Electronic Data Sheet (EDS) integrated in the measuring instrument</li> </ul>
<b>Configuration of the EtherNet interface</b>	<ul style="list-style-type: none"> <li>▪ Speed: 10 MBit, 100 MBit, auto (factory setting)</li> <li>▪ Duplex: half-duplex, full-duplex, auto (factory setting)</li> </ul>
<b>Configuration of the device address</b>	<ul style="list-style-type: none"> <li>▪ DIP switches on the electronics module for IP addressing (last octet)</li> <li>▪ DHCP</li> <li>▪ Manufacturer-specific software (FieldCare)</li> <li>▪ Add-on Profile Level 3 for Rockwell Automation control systems</li> <li>▪ Web browser</li> <li>▪ Ethernet/IP tools, e.g. RSLinx (Rockwell Automation)</li> </ul>
<b>Device Level Ring (DLR)</b>	No

<b>Fix input</b>			
<b>RPI</b>	5 ms to 10 s (factory setting: 20 ms)		
<b>Exclusive Owner Multicast</b>		<b>Instance</b>	<b>Size [byte]</b>
	Instance configuration:	0x68	398
	O → T configuration:	0x66	64
	T → O configuration:	0x64	44
<b>Exclusive Owner Multicast</b>		<b>Instance</b>	<b>Size [byte]</b>
	Instance configuration:	0x69	-
	O → T configuration:	0x66	64
	T → O configuration:	0x64	44
<b>Input only Multicast</b>		<b>Instance</b>	<b>Size [byte]</b>
	Instance configuration:	0x68	398
	O → T configuration:	0xC7	-
	T → O configuration:	0x64	44
<b>Input only Multicast</b>		<b>Instance</b>	<b>Size [byte]</b>
	Instance configuration:	0x69	-
	O → T configuration:	0xC7	-
	T → O configuration:	0x64	44
<b>Input Assembly</b>	<ul style="list-style-type: none"> <li>▪ Current device diagnostics</li> <li>▪ Mass flow</li> <li>▪ Volume flow</li> <li>▪ Corrected volume flow</li> <li>▪ Density</li> <li>▪ Reference density</li> <li>▪ Temperature</li> <li>▪ Totalizer 1</li> <li>▪ Totalizer 2</li> <li>▪ Totalizer 3</li> </ul>		
<b>Configurable Input</b>			
<b>RPI</b>	5 ms to 10 s (factory setting: 20 ms)		
<b>Exclusive Owner Multicast</b>		<b>Instance</b>	<b>Size [byte]</b>
	Instance configuration:	0x68	398
	O → T configuration:	0x66	64
	T → O configuration:	0x65	88
<b>Exclusive Owner Multicast</b>		<b>Instance</b>	<b>Size [byte]</b>
	Instance configuration:	0x69	-
	O → T configuration:	0x66	64
	T → O configuration:	0x65	88
<b>Input only Multicast</b>		<b>Instance</b>	<b>Size [byte]</b>
	Instance configuration:	0x68	398
	O → T configuration:	0xC7	-
	T → O configuration:	0x65	88
<b>Input only Multicast</b>		<b>Instance</b>	<b>Size [byte]</b>
	Instance configuration:	0x69	-
	O → T configuration:	0xC7	-
	T → O configuration:	0x65	88

<b>Configurable Input Assembly</b>	<ul style="list-style-type: none"> <li>■ Current device diagnostics</li> <li>■ Mass flow</li> <li>■ Volume flow</li> <li>■ Corrected volume flow</li> <li>■ Density</li> <li>■ Reference density</li> <li>■ Temperature</li> <li>■ Totalizer 1</li> <li>■ Totalizer 2</li> <li>■ Totalizer 3</li> </ul> <p> The range of options increases if the measuring device has one or more application packages.</p>
<b>Fix output</b>	
<b>Output Assembly</b>	<ul style="list-style-type: none"> <li>■ Activation of reset totalizers 1-3</li> <li>■ Activation of pressure compensation</li> <li>■ Activation of reference density compensation</li> <li>■ Activation of temperature compensation</li> <li>■ Reset totalizers 1-3</li> <li>■ External pressure value</li> <li>■ Pressure unit</li> <li>■ External reference density</li> <li>■ Reference density unit</li> <li>■ External temperature</li> <li>■ Temperature unit</li> </ul>
<b>Configuration</b>	
<b>Configuration Assembly</b>	<p>Only the most common configurations are listed below.</p> <ul style="list-style-type: none"> <li>■ Software write protection</li> <li>■ Mass flow unit</li> <li>■ Mass unit</li> <li>■ Volume flow unit</li> <li>■ Volume unit</li> <li>■ Corrected volume flow unit</li> <li>■ Corrected volume unit</li> <li>■ Density unit</li> <li>■ Reference density unit</li> <li>■ Temperature unit</li> <li>■ Pressure unit</li> <li>■ Length</li> <li>■ Totalizer 1-3:                             <ul style="list-style-type: none"> <li>■ Assignment</li> <li>■ Unit</li> <li>■ Mode of operation</li> <li>■ Failure mode</li> </ul> </li> <li>■ Alarm delay</li> </ul>

**PROFINET**

<b>Protocol</b>	"Application layer protocol for decentral device periphery and distributed automation", version 2.3
<b>Conformity class</b>	B
<b>Communication type</b>	100 Mbps
<b>Device profile</b>	Application interface identifier 0xF600 Generic device
<b>Manufacturer ID</b>	0x11
<b>Device type ID</b>	0x844A
<b>Device description files (GSD, DTM)</b>	Information and files available at: <ul style="list-style-type: none"> <li>■ <a href="https://www.endress.com/download">https://www.endress.com/download</a> On the device product page: PRODUCTS → Product Finder → Links</li> <li>■ <a href="https://www.profibus.com">https://www.profibus.com</a></li> </ul>
<b>Baud rates</b>	Automatic 100 Mbit/s with full-duplex detection

<b>Periods</b>	From 8 ms
<b>Polarity</b>	Auto-polarity for automatic correction of crossed TxD and RxD pairs
<b>Supported connections</b>	<ul style="list-style-type: none"> <li>▪ 1 x AR (Application Relation)</li> <li>▪ 1 x Input CR (Communication Relation)</li> <li>▪ 1 x Output CR (Communication Relation)</li> <li>▪ 1 x Alarm CR (Communication Relation)</li> </ul>
<b>Configuration options for measuring instrument</b>	<ul style="list-style-type: none"> <li>▪ DIP switches on the electronics module, for device name assignment (last part)</li> <li>▪ Manufacturer-specific software (FieldCare, DeviceCare)</li> <li>▪ Web browser</li> <li>▪ Device master file (GSD), can be read out via the integrated web server of the measuring instrument</li> </ul>
<b>Configuration of the device name</b>	<ul style="list-style-type: none"> <li>▪ DIP switches on the electronics module, for device name assignment (last part)</li> <li>▪ DCP protocol</li> </ul>
<b>Output values</b> (from measuring instrument to automation system)	<p><b>Analog Input module (slot 1 to 14)</b></p> <ul style="list-style-type: none"> <li>▪ Mass flow</li> <li>▪ Volume flow</li> <li>▪ Corrected volume flow</li> <li>▪ Target mass flow</li> <li>▪ Carrier mass flow</li> <li>▪ Density</li> <li>▪ Reference density</li> <li>▪ Concentration</li> <li>▪ Temperature</li> <li>▪ Carrier pipe temperature</li> <li>▪ Electronics temperature</li> <li>▪ Oscillation frequency</li> <li>▪ Oscillation amplitude</li> <li>▪ Frequency fluctuation</li> <li>▪ Oscillation damping</li> <li>▪ Tube damping fluctuation</li> <li>▪ Signal asymmetry</li> <li>▪ Exciter current</li> </ul> <p><b>Discrete Input module (slot 1 to 14)</b></p> <ul style="list-style-type: none"> <li>▪ Empty pipe detection</li> <li>▪ Low flow cut off</li> </ul> <p><b>Diagnostics Input module (slot 1 to 14)</b></p> <ul style="list-style-type: none"> <li>▪ Last diagnostics</li> <li>▪ Current diagnostics</li> </ul> <p><b>Totalizer 1 to 3 (slot 15 to 17)</b></p> <ul style="list-style-type: none"> <li>▪ Mass flow</li> <li>▪ Volume flow</li> <li>▪ Corrected volume flow</li> </ul> <p><b>Heartbeat Verification module (fixed assignment)</b> Verification status (slot 23)</p> <p> The range of options increases if the measuring device has one or more application packages.</p>

<p><b>Input values</b> (from automation system to measuring instrument)</p>	<p><b>Analog Output module (fixed assignment)</b></p> <ul style="list-style-type: none"> <li>▪ External pressure (slot 18)</li> <li>▪ External temperature (slot 19)</li> <li>▪ External reference density (slot 20)</li> </ul> <p><b>Discrete Output module (fixed assignment)</b></p> <ul style="list-style-type: none"> <li>▪ Activate/deactivate positive zero return (slot 21)</li> <li>▪ Perform zero adjustment (slot 22)</li> </ul> <p><b>Totalizer 1 to 3 (slot 15 to 17)</b></p> <ul style="list-style-type: none"> <li>▪ Totalize</li> <li>▪ Reset and hold</li> <li>▪ Preset and hold</li> <li>▪ Stop</li> <li>▪ Operating mode configuration:             <ul style="list-style-type: none"> <li>▪ Net flow total</li> <li>▪ Forward flow total</li> <li>▪ Reverse flow total</li> </ul> </li> </ul> <p><b>Heartbeat Verification module (fixed assignment)</b> Start verification (slot 23)</p> <p> The range of options increases if the measuring device has one or more application packages.</p>
<p><b>Supported functions</b></p>	<ul style="list-style-type: none"> <li>▪ Identification &amp; maintenance Simple device identification via:             <ul style="list-style-type: none"> <li>▪ Control system</li> <li>▪ Nameplate</li> </ul> </li> <li>▪ Measured value status The process variables are communicated with a measured value status</li> <li>▪ Blinking feature via the local display for simple device identification and assignment</li> </ul>

*Administration of software options*

Input/output value	Process variable	Category	Slot
Output value	Mass flow	Process variable	1...14
	Volume flow		
	Corrected volume flow		
	Density		
	Reference density		
	Temperature		
	Electronics temperature		
	Oscillation frequency		
	Frequency fluctuation		
	Oscillation damping		
	Oscillation frequency		
	Signal asymmetry		
	Exciter current		
	Empty pipe detection		
	Low flow cut off		
Output value	Target mass flow	Concentration <sup>1)</sup>	1...14
	Carrier mass flow		
	Concentration		
Output value	Carrier pipe temperature	Heartbeat Technology <sup>2)</sup>	1...14

Input/output value	Process variable	Category	Slot
	Oscillation damping 1		
	Oscillation frequency 1		
	Oscillation amplitude 0		
	Oscillation amplitude 1		
	Frequency fluctuation 1		
	Tube damping fluctuation 1		
	Exciter current 1		
Input value	External density	Process monitoring	18
	External temperature		19
	External reference density		20
	Flow override		21
	Zero adjustment		22
	Verification status	Heartbeat Verification <sup>2)</sup>	23

- 1) Only available with the "Concentration" application package.  
2) Only available with the Heartbeat Technology application package.

*Startup configuration*

Startup configuration (NSU)	<p>If startup configuration is enabled, the configuration of the most important device parameters is taken from the automation system and used.</p> <p>The following configuration is taken from the automation system:</p> <ul style="list-style-type: none"> <li>▪ Management <ul style="list-style-type: none"> <li>▪ Software revision</li> <li>▪ Write protection</li> </ul> </li> <li>▪ System units <ul style="list-style-type: none"> <li>▪ Mass flow</li> <li>▪ Mass</li> <li>▪ Volume flow</li> <li>▪ Volume</li> <li>▪ Corrected volume flow</li> <li>▪ Corrected volume</li> <li>▪ Density</li> <li>▪ Reference density</li> <li>▪ Temperature</li> <li>▪ Pressure</li> </ul> </li> <li>▪ Concentration application package <ul style="list-style-type: none"> <li>▪ Coefficients A0 to A4</li> <li>▪ Coefficients B1 to B3</li> </ul> </li> <li>▪ Sensor adjustment</li> <li>▪ Process parameters <ul style="list-style-type: none"> <li>▪ Damping (flow, density, temperature)</li> <li>▪ Flow override</li> </ul> </li> <li>▪ Low flow cut off <ul style="list-style-type: none"> <li>▪ Assign process variable</li> <li>▪ Switch-on/switch-off point</li> <li>▪ Pressure shock suppression</li> </ul> </li> <li>▪ Empty pipe detection <ul style="list-style-type: none"> <li>▪ Assign process variable</li> <li>▪ Limit values</li> <li>▪ Response time</li> <li>▪ Max. damping</li> </ul> </li> <li>▪ Corrected volume flow calculation <ul style="list-style-type: none"> <li>▪ External reference density</li> <li>▪ Fixed reference density</li> <li>▪ Reference temperature</li> <li>▪ Linear expansion coefficient</li> <li>▪ Square expansion coefficient</li> </ul> </li> <li>▪ Measuring mode <ul style="list-style-type: none"> <li>▪ Medium</li> <li>▪ Gas type</li> <li>▪ Reference sound velocity</li> <li>▪ Temperature coefficient sound velocity</li> </ul> </li> <li>▪ External compensation <ul style="list-style-type: none"> <li>▪ Pressure compensation</li> <li>▪ Pressure value</li> <li>▪ External pressure</li> </ul> </li> <li>▪ Diagnostic settings</li> <li>▪ Diagnostic behavior for diverse diagnostic information</li> </ul>
-----------------------------	------------------------------------------------------------------------------------------------------------------------------------------------------------------------------------------------------------------------------------------------------------------------------------------------------------------------------------------------------------------------------------------------------------------------------------------------------------------------------------------------------------------------------------------------------------------------------------------------------------------------------------------------------------------------------------------------------------------------------------------------------------------------------------------------------------------------------------------------------------------------------------------------------------------------------------------------------------------------------------------------------------------------------------------------------------------------------------------------------------------------------------------------------------------------------------------------------------------------------------------------------------------------------------------------------------------------------------------------------------------------------------------------------------------------------------------------------------------------------------------------------------------------------------------------------------------------------------------------------------------------------------------------------------------------------------------------------------------------------------------------------------------------------------------------------------------------------------------------------------------------------------------------------------------------------------------------------------------------------------------------------------------------------------------------------------------------------------------------------------------------------------------------------------------------------

## Power supply

### Terminal assignment

### Overview: housing version and connection versions

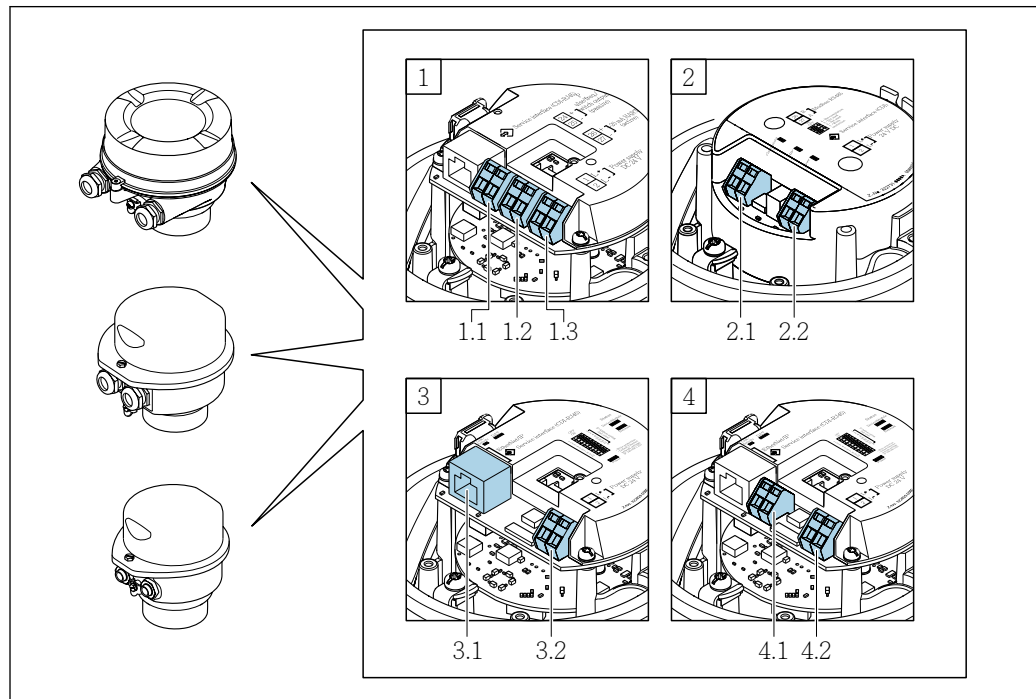

A0016770

- A Housing version: compact, aluminum coated
- B Housing version: compact, hygienic, stainless
- C Housing version: ultra-compact, hygienic, stainless
- 1 Connection version: 4-20 mA HART, pulse/frequency/switch output
  - 1.1 Signal transmission: pulse/frequency/switch output
  - 1.2 Signal transmission: 4-20 mA HART
  - 1.3 Supply voltage
- 2 Connection version: Modbus RS485
  - 2.1 Signal transmission
  - 2.2 Supply voltage
- 3 Connection versions: EtherNet/IP and PROFINET
  - 3.1 Signal transmission
  - 3.2 Supply voltage
- 4 Connection version: PROFIBUS DP
  - 4.1 Signal transmission
  - 4.2 Supply voltage

### Transmitter

Connection version 4-20 mA HART with pulse/frequency/switch output

Order code for "Output", option **B**



Depending on the housing version, the transmitters can be ordered with terminals or device plugs.

Order code "Housing"	Connection methods available		Possible options for order code "Electrical connection"
	Outputs	Power supply	
Options A, B	Terminals	Terminals	<ul style="list-style-type: none"> <li>Option A: coupling M20x1</li> <li>Option B: thread M20x1</li> <li>Option C: thread G 1/2"</li> <li>Option D: thread NPT 1/2"</li> </ul>
Options A, B	Device plugs → 32	Terminals	<ul style="list-style-type: none"> <li>Option L: plug M12x1 + thread NPT 1/2"</li> <li>Option N: plug M12x1 + coupling M20</li> <li>Option P: plug M12x1 + thread G 1/2"</li> <li>Option U: plug M12x1 + thread M20</li> </ul>
Options A, B, C	Device plugs → 32	Device plugs → 32	Option Q: 2 x plug M12x1

Order code for "Housing":

- Option A: compact, coated aluminum
- Option B: compact, hygienic, stainless
- Option C: ultra-compact, hygienic, stainless

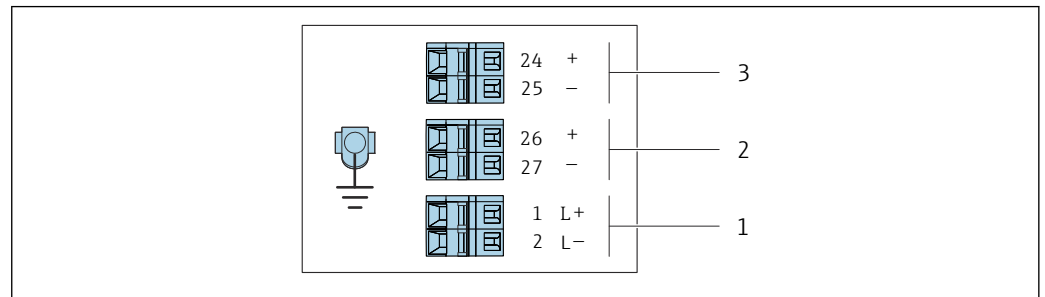

A0016888

2 Terminal assignment 4-20 mA HART with pulse/frequency/switch output

- 1 Power supply: DC 24 V
- 2 Output 1: 4-20 mA HART (active)
- 3 Output 2: pulse/frequency/switch output (passive)

Order code "Output"	Terminal number					
	Power supply		Output 1		Output 2	
	2 (L-)	1 (L+)	27 (-)	26 (+)	25 (-)	24 (+)
Option B	DC 24 V		4-20 mA HART (active)		Pulse/frequency/switch output (passive)	

Order code for "Output":



Option B: 4-20 mA HART with pulse/frequency/switch output

*PROFIBUS DP connection version*

 For use in the non-hazardous area and Zone 2/Div. 2

Order code for "Output", option **L**

Depending on the housing version, the transmitters can be ordered with terminals or device plugs.

Order code "Housing"	Connection methods available		Possible options for order code "Electrical connection"
	Output	Power supply	
Options A, B	Terminals	Terminals	<ul style="list-style-type: none"> <li>▪ Option A: coupling M20x1</li> <li>▪ Option B: thread M20x1</li> <li>▪ Option C: thread G ½"</li> <li>▪ Option D: thread NPT ½"</li> </ul>
Options A, B	Device plug connectors →  32	Terminals	<ul style="list-style-type: none"> <li>▪ Option L: plug M12x1 + thread NPT ½"</li> <li>▪ Option N: plug M12x1 + coupling M20</li> <li>▪ Option P: plug M12x1 + thread G ½"</li> <li>▪ Option U: plug M12x1 + thread M20</li> </ul>
Options A, B, C	Device plug connectors →  32	Device plug connectors →  32	Option Q: 2 x plug M12x1
Order code for "Housing": <ul style="list-style-type: none"> <li>▪ Option A: compact, coated aluminum</li> <li>▪ Option B: compact, hygienic, stainless</li> <li>▪ Option C ultra-compact, hygienic, stainless</li> </ul>			

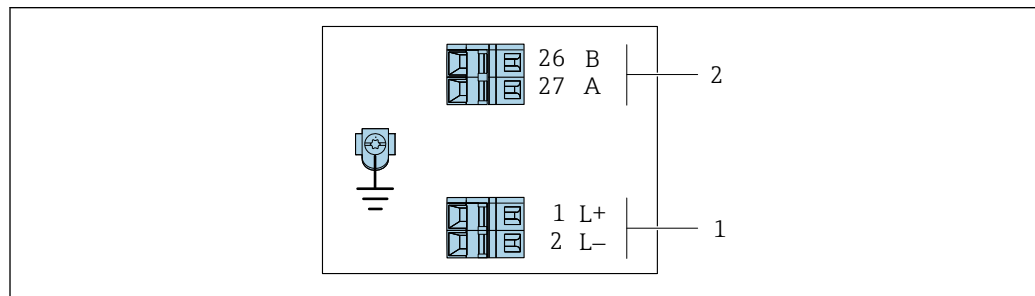

A0022716

 3 PROFIBUS DP terminal assignment

- 1 Power supply: DC 24 V
- 2 PROFIBUS DP



Order code "Output"	Terminal number			
	Power supply		Output	
	2 (L-)	1 (L+)	26 (RxD/TxD-P)	27 (RxD/TxD-N)
Option L	DC 24 V		B	A
Order code for "Output": Option L: PROFIBUS DP, for use in non-hazardous areas and Zone 2/Div. 2				

Modbus RS485 connection version

 For use in the non-hazardous area and Zone 2/Div. 2

Order code for "Output", option **M**

Depending on the housing version, the transmitters can be ordered with terminals or device plugs.

Order code "Housing"	Connection methods available		Possible options for order code "Electrical connection"
	Output	Power supply	
Options A, B	Terminals	Terminals	<ul style="list-style-type: none"> <li>▪ Option A: coupling M20x1</li> <li>▪ Option B: thread M20x1</li> <li>▪ Option C: thread G ½"</li> <li>▪ Option D: thread NPT ½"</li> </ul>
Options A, B	Device plugs →  32	Terminals	<ul style="list-style-type: none"> <li>▪ Option L: plug M12x1 + thread NPT ½"</li> <li>▪ Option N: plug M12x1 + coupling M20</li> <li>▪ Option P: plug M12x1 + thread G ½"</li> <li>▪ Option U: plug M12x1 + thread M20</li> </ul>
Options A, B, C	Device plugs →  32	Device plugs →  32	Option Q: 2 x plug M12x1
Order code for "Housing": <ul style="list-style-type: none"> <li>▪ Option A: compact, coated aluminum</li> <li>▪ Option B: compact, hygienic, stainless</li> <li>▪ Option C: ultra-compact, hygienic, stainless</li> </ul>			

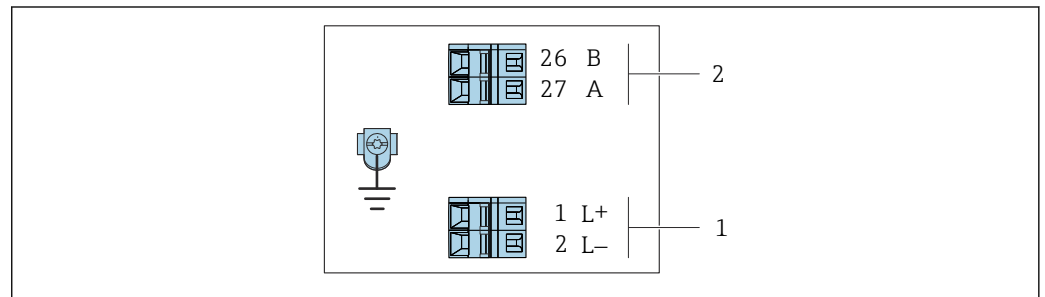

A0019528

 4 Modbus RS485 terminal assignment, connection version for use in non-hazardous areas and Zone 2/Div. 2

- 1 Power supply: DC 24 V
- 2 Modbus RS485

Order code "Output"	Terminal number			
	Power supply		Output	
	1 (L+)	2 (L-)	26 (B)	27 (A)
Option M	DC 24 V		Modbus RS485	
Order code for "Output": Option <b>M</b> : Modbus RS485, for use in non-hazardous areas and Zone 2/Div. 2				

Modbus RS485 connection version

 For use in the intrinsically safe area. Connection via Safety Barrier Promass 100.

Order code for "Output", option **M**

Depending on the housing version, the transmitters can be ordered with terminals or device plugs.

Order code "Housing"	Connection methods available		Possible options for order code "Electrical connection"
	Output	Power supply	
Options A, B	Terminals	Terminals	<ul style="list-style-type: none"> <li>▪ Option A: coupling M20x1</li> <li>▪ Option B: thread M20x1</li> <li>▪ Option C: thread G ½"</li> <li>▪ Option D: thread NPT ½"</li> </ul>
A, B, C	Device plugs →  32		Option I: plug M12x1
Order code for "Housing": <ul style="list-style-type: none"> <li>▪ Option A: compact, coated aluminum</li> <li>▪ Option B: compact, hygienic, stainless</li> <li>▪ Option C: ultra-compact, hygienic, stainless</li> </ul>			

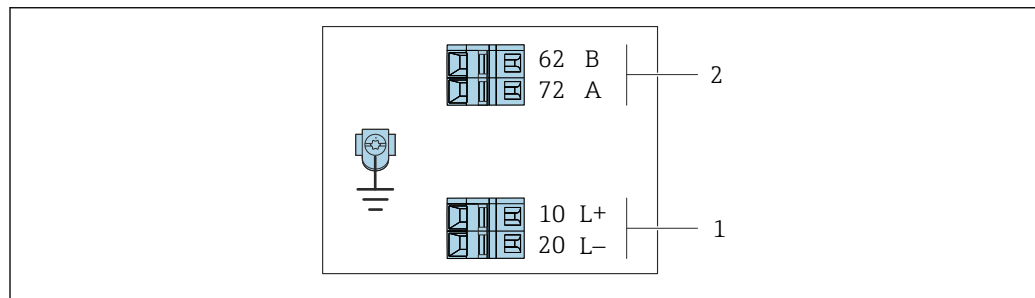

A0030219

 5 Modbus RS485 terminal assignment, connection version for use in intrinsically safe areas (connection via Safety Barrier Promass 100)

1 Intrinsically safe power supply





2 Modbus RS485

Order code "Output"	10 (L+)	20 (L-)	62 (B)	72 (A)
Option <b>M</b>	Intrinsically safe supply voltage		Modbus RS485 intrinsically safe	
Order code for "Output": Option <b>M</b> : Modbus RS485, for use in the intrinsically safe area (connection via Safety Barrier Promass 100)				

*EtherNet/IP connection version*

Order code for "Output", option **N**

Depending on the housing version, the transmitters can be ordered with terminals or device plugs.

Order code "Housing"	Connection methods available		Possible options for order code "Electrical connection"
	Output	Power supply	
Options <b>A, B</b>	Device plug connectors →  33	Terminals	<ul style="list-style-type: none"> <li>▪ Option <b>L</b>: plug M12x1 + thread NPT ½"</li> <li>▪ Option <b>N</b>: plug M12x1 + coupling M20</li> <li>▪ Option <b>P</b>: plug M12x1 + thread G ½"</li> <li>▪ Option <b>U</b>: plug M12x1 + thread M20</li> </ul>
Options <b>A, B, C</b>	Device plug connectors →  33	Device plug connectors →  33	Option <b>Q</b> : 2 x plug M12x1
Options <b>A, B, C</b>	Device plug connectors →  33	Device plug connectors →  33	Option <b>I</b> : Plug M12x1

Order code for "Housing":

- Option **A**: compact, coated aluminum
- Option **B**: compact, hygienic, stainless
- Option **C** ultra-compact, hygienic, stainless

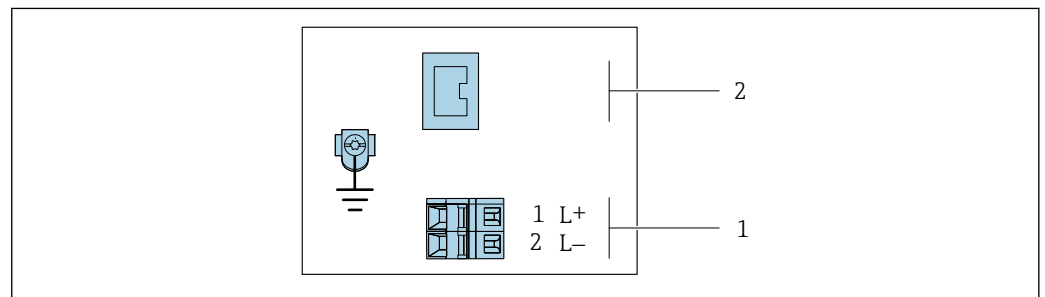

A0017054

 6 *EtherNet/IP terminal assignment*

- 1 Power supply: DC 24 V
- 2 EtherNet/IP

Order code "Output"	Terminal number		Output Device plug M12x1
	Power supply 2 (L-)	1 (L+)	
Option <b>N</b>	DC 24 V		EtherNet/IP

Order code for "Output":  
Option **N**: EtherNet/IP

*PROFINET connection version*

Order code for "Output", option **R**

Depending on the housing version, the transmitters can be ordered with terminals or device plugs.

Order code "Housing"	Connection methods available		Possible options for order code "Electrical connection"
	Output	Power supply	
Options <b>A, B</b>	Device plug connectors → 31	Terminals	<ul style="list-style-type: none"> <li>▪ Option <b>L</b>: plug M12x1 + thread NPT ½"</li> <li>▪ Option <b>N</b>: plug M12x1 + coupling M20</li> <li>▪ Option <b>P</b>: plug M12x1 + thread G ½"</li> <li>▪ Option <b>U</b>: plug M12x1 + thread M20</li> </ul>
Options <b>A, B, C</b>	Device plug connectors → 31	Device plug connectors → 31	Option <b>Q</b> : 2 x plug M12x1
Options <b>A, B, C</b>	Device plug connectors → 31	Device plug connectors → 31	Option <b>I</b> : Plug M12x1

Order code for "Housing":

- Option **A**: compact, coated aluminum
- Option **B**: compact, hygienic, stainless
- Option **C** ultra-compact, hygienic, stainless

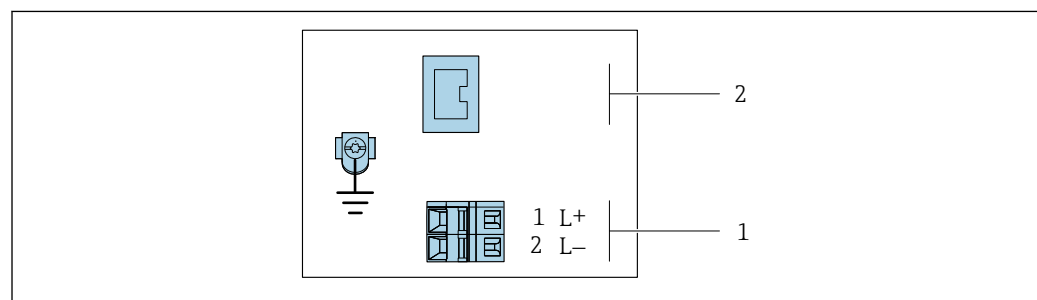

A0017054

7 *PROFINET terminal assignment*

- 1 Power supply: DC 24 V
- 2 PROFINET

Order code "Output"	Terminal number		Output Device plug M12x1
	Power supply 2 (L-)	1 (L+)	
Option <b>R</b>	DC 24 V		PROFINET

Order code for "Output":  
Option **R**: PROFINET

**Safety Barrier Promass 100**

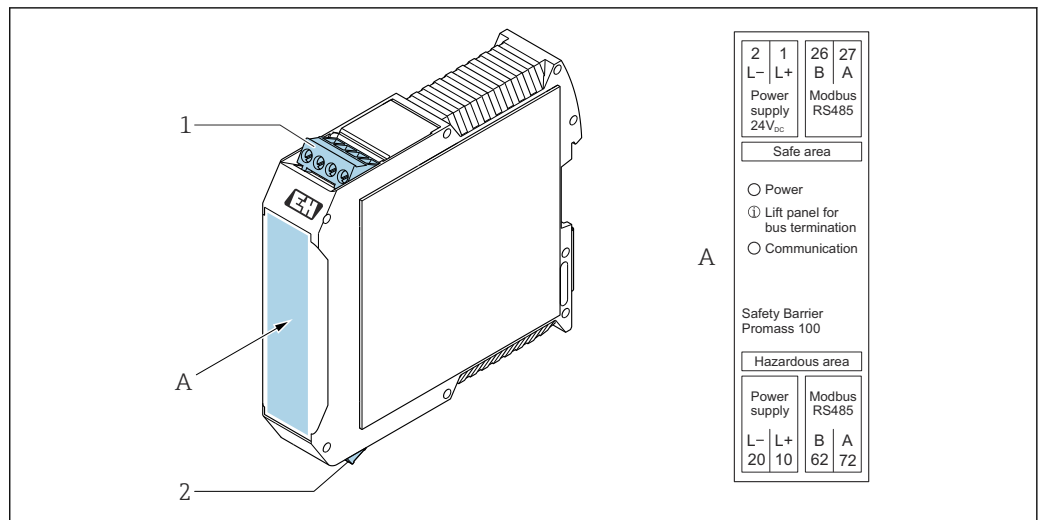

8 Safety Barrier Promass 100 with terminals

- 1 Non-hazardous area, Zone 2, Class I Division 2
- 2 Intrinsically safe area

**Pin assignment, device plug**

- i** Order codes for the M12x1 plugs, see the "Order code for **electrical connection**" column:
  - 4-20 mA HART, pulse/frequency/switch output → 24
  - PROFIBUS DP → 26
  - Modbus RS485 → 27
  - Ethernet/IP → 29
  - PROFINET → 30

**Supply voltage**

*Intrinsically safe for all connection versions except MODBUS RS485 (device side), male connection (plug)*

- i** Device plug MODBUS RS485 intrinsically safe with supply voltage → 32

<p style="text-align: center; font-size: small;">A0029042</p>	Pin		Assignment
	1	L+	DC 24 V
	2		Not assigned
	3		Not assigned
	4	L-	DC 24 V
	5		Grounding/shielding <sup>1)</sup>
Coding		Plug/socket	
A		Plug	

1) Not assigned for order code for "Housing", option C "Ultra-compact, hygienic, stainless"

- i** The following is recommended as a socket:
  - Binder, series 763, part no. 79 3440 35 05
  - Alternatively: Phoenix part no. 1682951 SAC-5P-5.0-PUR/M12FS SH
    - With the order code for "Output", option **B**: 4-20 mA HART, pulse/frequency/switch output
    - With the order code for "Output", option **N**: EtherNet/IP
  - When using the device in a hazardous location: Use a suitably certified socket.

### 4-20 mA HART with pulse/frequency/switch output

Device plug for signal transmission (device side), female connection

	Pin	Assignment	
	1	+	4-20 mA HART (active)
	2	-	4-20 mA HART (active)
	3	+	Pulse/frequency/switch output (passive)
	4	-	Pulse/frequency/switch output (passive)
	5		Grounding/shielding <sup>1)</sup>
Coding		Plug/socket	
A		Socket	

1) Not assigned for order code for "Housing", option C "Ultra-compact, hygienic, stainless"

- Recommended plug: Binder, series 763, part no. 79 3439 12 05
- When using the device in a hazardous location, use a suitably certified plug.

### PROFIBUS DP

For use in the non-hazardous area and Zone 2/Div. 2.

Device plug for signal transmission (device side)

	Pin	Assignment	
	1		Not assigned
	2	A	PROFIBUS DP
	3		Not assigned
	4	B	PROFIBUS DP
	5		Grounding/shielding <sup>1)</sup>
Coding		Plug/socket	
B		Socket	

1) Not assigned for order code for "Housing", option C "Ultra-compact, hygienic, stainless"

- Recommended plug: Binder, series 763, part no. 79 4449 20 05
- When using the device in a hazardous location, use a suitably certified plug.

### MODBUS RS485

Device plug for signal transmission with supply voltage (device side), MODBUS RS485 (intrinsically safe)

	Pin	Assignment	
	1	L+	Supply voltage, intrinsically safe
	2	A	Modbus RS485, intrinsically safe
	3	B	
	4	L-	Supply voltage, intrinsically safe
	5		Grounding/shielding <sup>1)</sup>
Coding		Plug/socket	
A		Plug	

1) Not assigned for order code for "Housing", option C "Ultra-compact, hygienic, stainless"



-  Recommended socket: Binder, series 763, part no. 79 3439 12 05
- When using the device in a hazardous location: Use a suitably certified socket.

Device plug for signal transmission (device side), MODBUS RS485 (not intrinsically safe)

-  For use in the non-hazardous area and Zone 2/Div. 2.

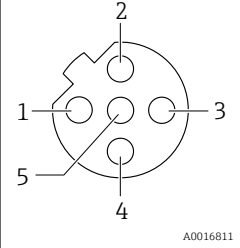
	Pin		Assignment
	1		Not assigned
	2	A	Modbus RS485
	3		Not assigned
	4	B	Modbus RS485
	5		Grounding/shielding <sup>1)</sup>
Coding		Plug/socket	
B		Socket	

1) Not assigned for order code for "Housing", option C "Ultra-compact, hygienic, stainless"

-  Recommended plug: Binder, series 763, part no. 79 4449 20 05
- When using the device in a hazardous location, use a suitably certified plug.

### EtherNet/IP

Device plug for signal transmission (device side)

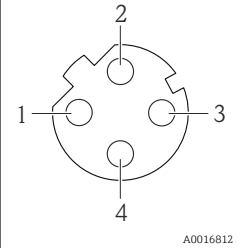
	Pin		Assignment
	1	+	Tx
	2	+	Rx
	3	-	Tx
	4	-	Rx
	Coding		Plug/socket
D		Socket	

-  Recommended plug:
  - Binder, series 763, part no. 99 3729 810 04
  - Phoenix, part no. 1543223 SACC-M12MSD-4Q
  - When using the device in a hazardous location, use a suitably certified plug.

### PROFINET

Device plug for signal transmission (device side)

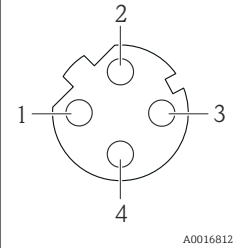
	Pin		Assignment
	1	+	TD +
	2	+	RD +
	3	-	TD -
	4	-	RD -
	Coding		Plug/socket
D		Socket	

-  Recommended plug:
  - Binder, series 825, part no. 99 3729 810 04
  - Phoenix, part no. 1543223 SACC-M12MSD-4Q
  - When using the device in a hazardous location, use a suitably certified plug.

**Supply voltage** The power unit must be tested to ensure it meets safety requirements (e.g. PELV, SELV).

**Transmitter**

For device version with communication type:

- HART, PROFIBUS DP, EtherNet/IP: DC 20 to 30 V
- Modbus RS485, device version:
  - For use in the non-hazardous area and Zone 2/Div. 2: DC 20 to 30 V
  - For use in the intrinsically safe area: power supply via Safety Barrier Promass 100

**Promass 100 safety barrier**

DC 20 to 30 V

**Power consumption**

**Transmitter**

Order code for "Output"	Maximum Power consumption
Option <b>B</b> : 4-20 mA HART with pulse/frequency/switch output	3.5 W
Option <b>L</b> : PROFIBUS DP	3.5 W
Option <b>M</b> Modbus RS485, for use in non-hazardous areas and Zone 2/Div. 2	3.5 W
Option <b>M</b> : Modbus RS485, for use in intrinsically safe areas	2.45 W
Option <b>N</b> : EtherNet/IP	3.5 W
Option <b>R</b> : PROFINET	3.5 W

*Promass 100 safety barrier*

Order code for "Output"	Maximum Power consumption
Option <b>M</b> : Modbus RS485, for use in intrinsically safe areas	4.8 W

**Current consumption**

**Transmitter**

Order code for "Output"	Maximum Current consumption	Maximum switch-on current
Option <b>B</b> : 4-20mA HART, pul./freq./switch output	145 mA	18 A (< 0.125 ms)
Option <b>L</b> : PROFIBUS DP	145 mA	18 A (< 0.125 ms)
Option <b>M</b> Modbus RS485, for use in non-hazardous areas and Zone 2/Div. 2	90 mA	10 A (< 0.8 ms)
Option <b>M</b> : Modbus RS485, for use in intrinsically safe areas	145 mA	16 A (< 0.4 ms)
Option <b>N</b> : EtherNet/IP	145 mA	18 A (< 0.125 ms)
Option <b>R</b> : PROFINET	145 mA	18 A (< 0.125 ms)

**Promass 100 safety barrier**

Order code for "Output"	Maximum Current consumption	Maximum switch-on current
Option <b>M</b> : Modbus RS485, for use in intrinsically safe areas	230 mA	10 A (< 0.8 ms)

**Device fuse**

Fine-wire fuse (slow-blow) T2A

**Power supply failure**

- Totalizers stop at the last value measured.
- Depending on the device version, the configuration is retained in the device memory or in the pluggable data memory (HistoROM DAT).
- Error messages (incl. total operated hours) are stored.

**Electrical connection**

**Connecting the transmitter**

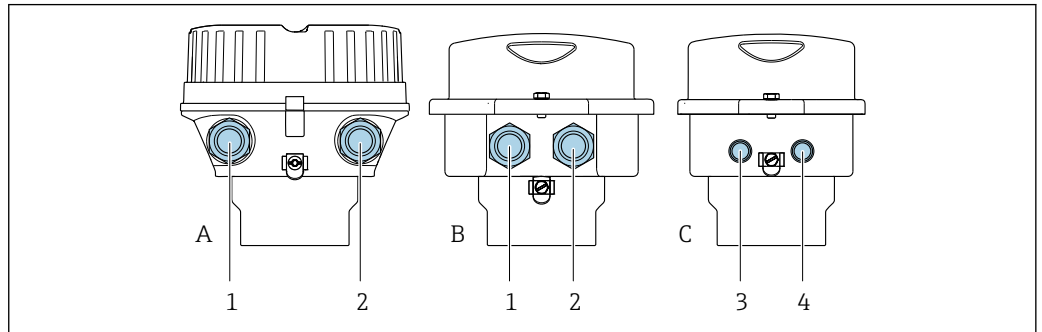

- A Housing version: compact, coated, aluminum
- B Housing version: compact, hygienic, stainless
- 1 Cable entry or device plug for signal transmission
- 2 Cable entry or device plug for supply voltage
- C Housing version: ultra-compact, hygienic, stainless, M12 device plug
- 3 Device plug for signal transmission
- 4 Device plug for supply voltage

- Terminal assignment → 24
- Pin assignment, device plug → 31

In the case of device versions with a connector, the transmitter housing does not need to be opened to connect the signal cable or power supply cable.

**Connection examples**

*Current output 4 to 20 mA HART*

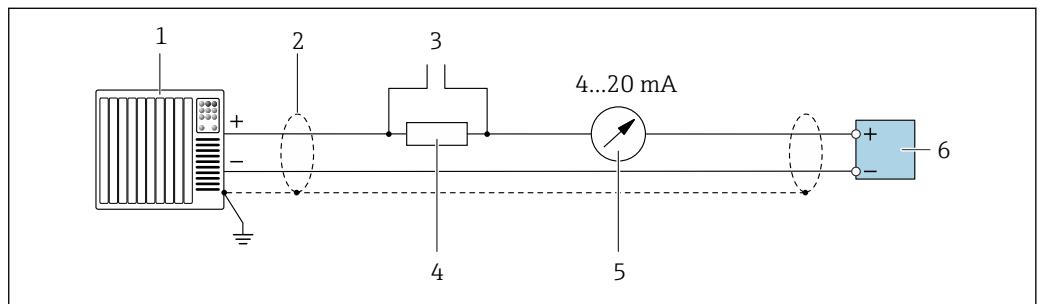

9 Connection example for 4 to 20 mA HART current output (active)

- 1 Automation system with current input (e.g. PLC)
- 2 Cable shield provided at one end. The cable shield must be grounded at both ends to comply with EMC requirements; observe cable specifications → 40
- 3 Connection for HART operating devices → 91
- 4 Resistor for HART communication ( $\geq 250 \Omega$ ): observe maximum load
- 5 Analog display unit: observe maximum load
- 6 Transmitter

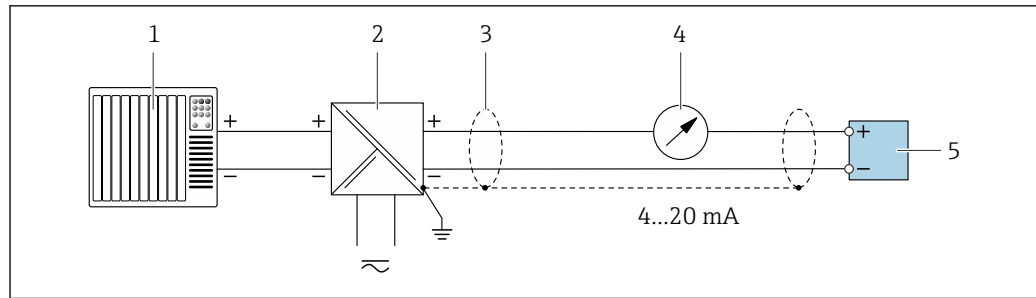

A0028762

10 Connection example for 4 to 20 mA HART current output (passive)

- 1 Automation system with current input (e.g. PLC)
- 2 Power supply
- 3 Cable shield provided at one end. The cable shield must be grounded at both ends to comply with EMC requirements; observe cable specifications → 40
- 4 Analog display unit: observe maximum load
- 5 Transmitter

### Pulse/frequency output

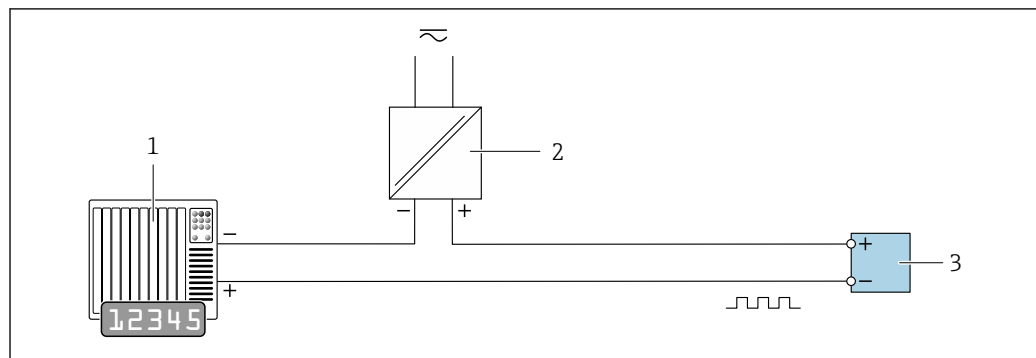

A0028761

11 Connection example for pulse/frequency output (passive)

- 1 Automation system with pulse/frequency input (e.g. PLC with 10 kΩ pull-up or pull-down resistor)
- 2 Power supply
- 3 Transmitter: observe input values → 10

### Switch output

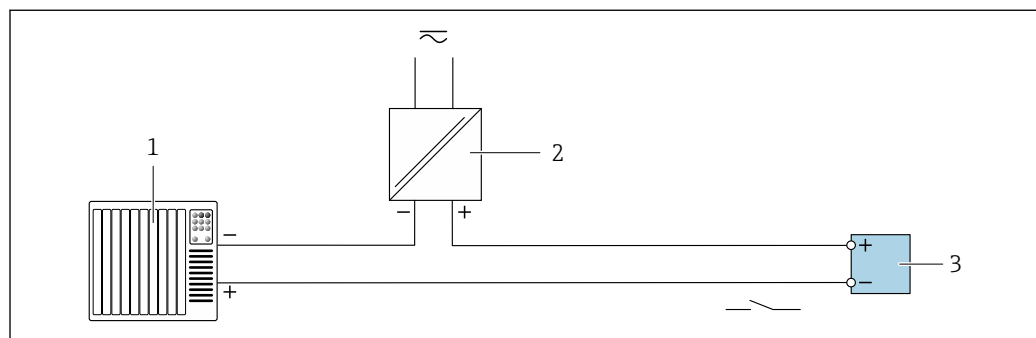

A0028760

12 Connection example for switch output (passive)

- 1 Automation system with switch input (e.g. PLC with a 10 kΩ pull-up or pull-down resistor)
- 2 Power supply
- 3 Transmitter: observe input values

PROFIBUS DP

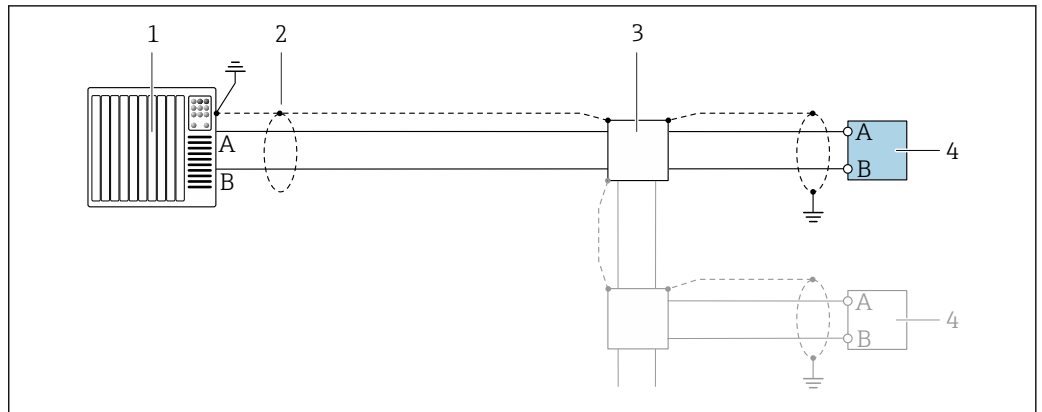

A0028765

13 Connection example for PROFIBUS DP, non-hazardous area and Zone 2/Div. 2

- 1 Control system (e.g. PLC)
- 2 Cable shield provided at one end. The cable shield must be grounded at both ends to comply with EMC requirements; observe cable specifications
- 3 Distribution box
- 4 Transmitter

**i** If baud rates > 1.5 MBaud an EMC cable entry must be used and the cable shield must continue as far as the terminal wherever possible.

Modbus RS485

Modbus RS485, non-hazardous area and Zone 2/Div. 2

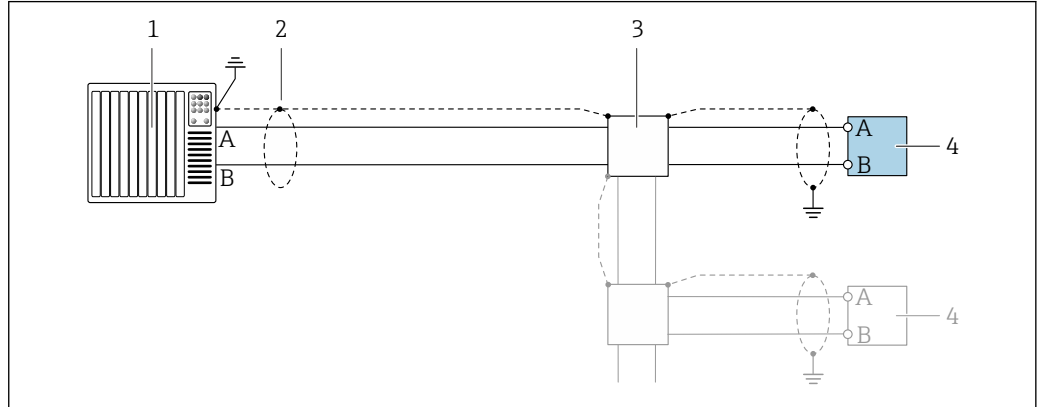

A0028765

14 Connection example for Modbus RS485, non-hazardous area and Zone 2/Div. 2

- 1 Control system (e.g. PLC)
- 2 Cable shield provided at one end. The cable shield must be grounded at both ends to comply with EMC requirements; observe cable specifications → 40
- 3 Distribution box
- 4 Transmitter

Modbus RS485 intrinsically safe

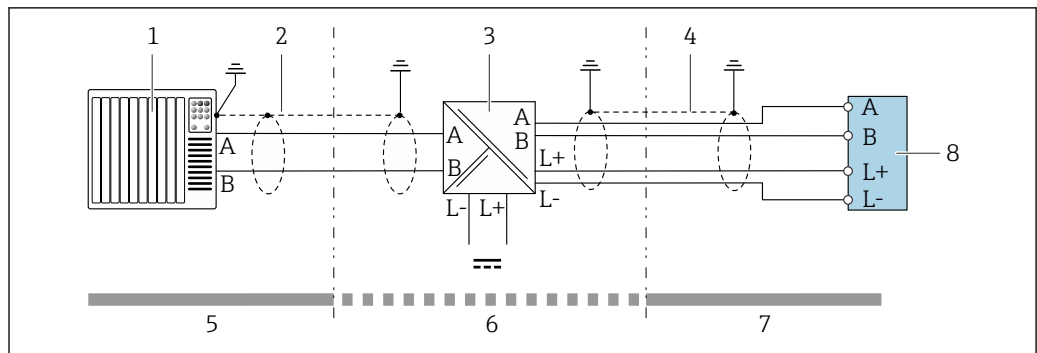

A0028766

15 Connection example for Modbus RS485 intrinsically safe

- 1 Control system (e.g. PLC)
- 2 Cable shield provided at one end. Observe cable specifications
- 3 Safety Barrier Promass 100
- 4 Observe cable specifications
- 5 Non-hazardous area
- 6 Non-hazardous area and Zone 2/Div. 2
- 7 Intrinsically safe area
- 8 Transmitter

EtherNet/IP

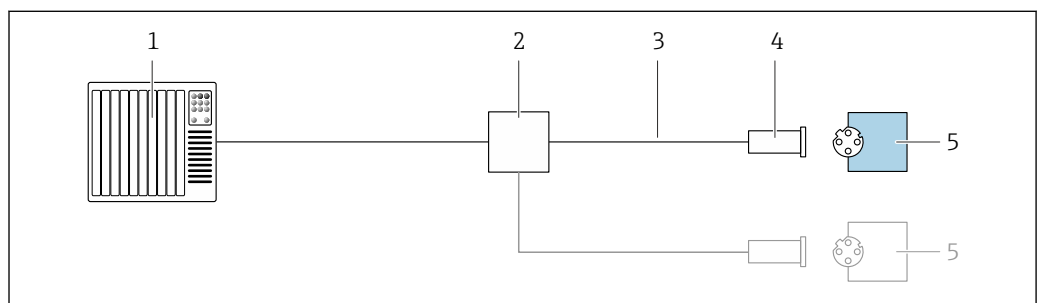

A0028767

16 Connection example for EtherNet/IP

- 1 Control system (e.g. PLC)
- 2 Ethernet switch
- 3 Observe cable specifications
- 4 Device plug
- 5 Transmitter

PROFINET

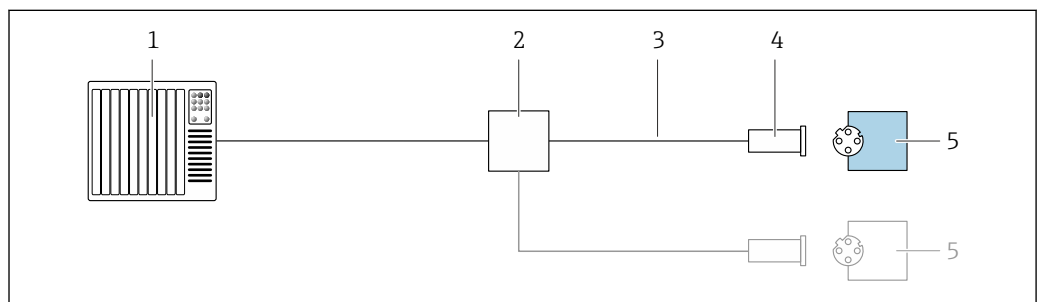

A0028767

17 Connection example for PROFINET

- 1 Control system (e.g. PLC)
- 2 Ethernet switch
- 3 Observe cable specifications
- 4 Device plug
- 5 Transmitter

HART input

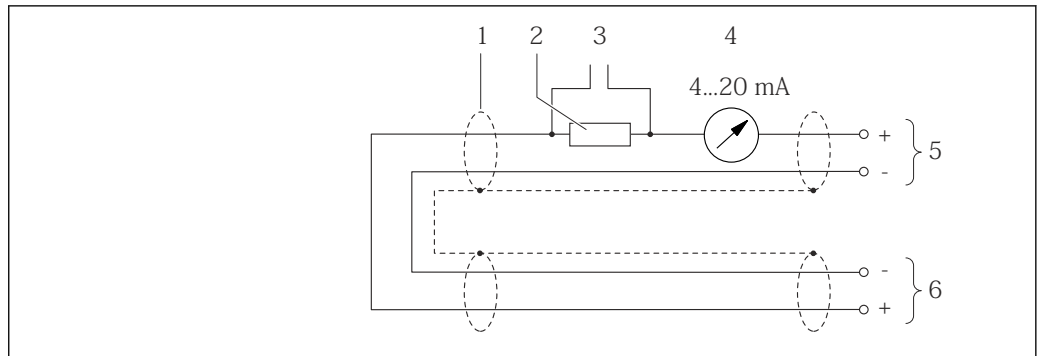

A0019828

18 Connection example for HART input (burst mode) via current output (active)

- 1 Cable shield provided at one end. Observe cable specifications
- 2 Resistor for HART communication ( $\geq 250 \Omega$ ): observe maximum load
- 3 Connection for HART operating devices
- 4 Analog display unit
- 5 Transmitter
- 6 Sensor for external measured variable

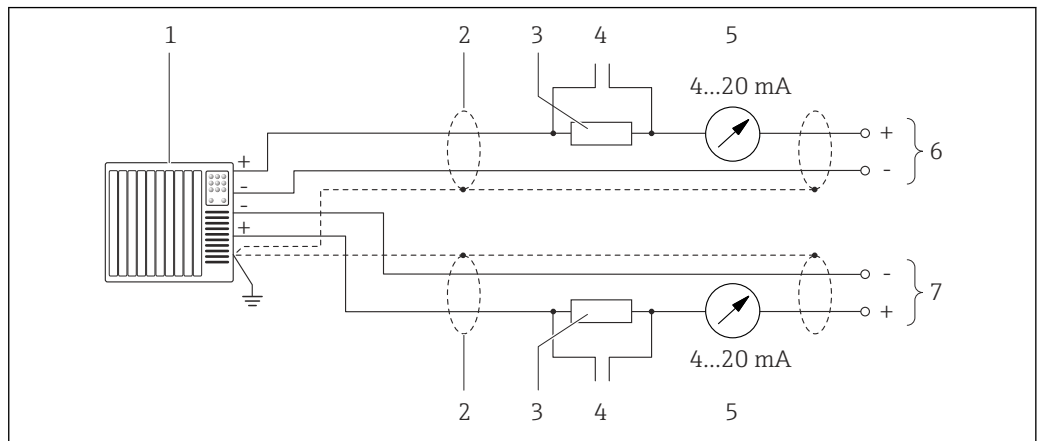

A0019830

19 Connection example for HART input (master mode) via current output (active)

- 1 Automation system with current input (e.g. PLC).  
Prerequisite: automation system with HART version 6, HART commands 113 and 114 can be processed.
- 2 Cable shield provided at one end. Observe cable specifications
- 3 Resistor for HART communication ( $\geq 250 \Omega$ ): observe maximum load
- 4 Connection for HART operating devices
- 5 Analog display unit
- 6 Transmitter
- 7 Sensor for external measured variable

Potential equalization

Requirements

For potential equalization:

- Pay attention to in-house grounding concepts
- Take account of operating conditions, such as the pipe material and grounding
- Connect the medium, sensor and transmitter to the same electric potential
- Use a ground cable with a minimum cross-section of  $6 \text{ mm}^2$  (10 AWG) and a cable lug for potential equalization connections

Terminals

Transmitter

Spring terminals for wire cross-sections  $0.5$  to  $2.5 \text{ mm}^2$  (20 to 14 AWG)

Promass 100 safety barrier

Plug-in screw terminals for wire cross-sections  $0.5$  to  $2.5 \text{ mm}^2$  (20 to 14 AWG)

**Cable entries**

- Cable gland: M20 × 1.5 with cable Ø 6 to 12 mm (0.24 to 0.47 in)
- Thread for cable entry:
  - M20
  - G ½"
  - NPT ½"

**Cable specification****Permitted temperature range**

- The installation guidelines that apply in the country of installation must be observed.
- The cables must be suitable for the minimum and maximum temperatures to be expected.

**Power supply cable (incl. conductor for the inner ground terminal)**

Standard installation cable is sufficient.

**Signal cable**

 For custody transfer, all signal lines must be shielded cables (tinned copper braiding, optical coverage ≥ 85 %). The cable shield must be connected on both sides.

*Current output 4 to 20 mA HART*

Shielded twisted-pair cable.

 See <https://www.fieldcommgroup.org> "HART PROTOCOL SPECIFICATIONS".

*Pulse /frequency /switch output*

Standard installation cable is sufficient.

*PROFIBUS DP*

Shielded twisted-pair cable. Cable type A is recommended.

 See <https://www.profibus.com> "PROFIBUS Installation Guidelines".

*Modbus RS485*

Shielded twisted-pair cable.

 See <https://modbus.org> "MODBUS over Serial Line Specification and Implementation Guide".

*EtherNet/IP*

Twisted-pair Ethernet CAT 5 or better.

 See <https://www.odva.org> "EtherNet/IP Media Planning & Installation Manual".

*PROFINET*

Only PROFINET cables.

 See <https://www.profibus.com> "PROFINET Planning guideline".

**Connecting cable between Safety Barrier Promass 100 and measuring device**

<b>Cable type</b>	Shielded twisted-pair cable with 2x2 wires. When grounding the cable shield, observe the grounding concept of the plant.
<b>Maximum cable resistance</b>	2.5 Ω, one side

 Comply with the maximum cable resistance specifications to ensure the operational reliability of the measuring device.





The maximum cable length for individual wire cross-sections is specified in the table below. Observe the maximum capacitance and inductance per unit length of the cable and connection values for hazardous areas .

Wire cross-section		Maximum cable length	
[mm <sup>2</sup> ]	[AWG]	[m]	[ft]
0.5	20	70	230
0.75	18	100	328
1.0	17	100	328
1.5	16	200	656
2.5	14	300	984

## Performance characteristics



### Reference operating conditions

- Error limits based on ISO 11631
  - Water
    - +15 to +45 °C (+59 to +113 °F)
    - 2 to 6 bar (29 to 87 psi)
  - Data as indicated in the calibration protocol
  - Accuracy based on accredited calibration rigs according to ISO 17025
-  To obtain measured errors, use the *Applicator* sizing tool →  102

### Maximum measurement error

o.r. = of reading; 1 g/cm<sup>3</sup> = 1 kg/l; T = medium temperature

#### Base accuracy

 Design fundamentals →  45

#### Mass flow and volume flow (liquids)

- ±0.05 % o.r. (optional for mass flow: PremiumCal; order code for "Calibration flow", option D)
- ±0.10 % o.r. (standard)

#### Mass flow (gases)

±0.25 % o.r.

#### Density (liquids)

Under reference conditions	Standard density calibration	Wide-range Density specification <sup>1) 2)</sup>	Extended density calibration <sup>3) 4)</sup>
[g/cm <sup>3</sup> ]	[g/cm <sup>3</sup> ]	[g/cm <sup>3</sup> ]	[g/cm <sup>3</sup> ]
±0.0005	±0.0005	±0.001	±0.0005

- 1) Valid range for special density calibration: 0 to 2 g/cm<sup>3</sup>, +5 to +80 °C (+41 to +176 °F)
- 2) order code for "Application package", option EE "Special density" (for nominal diameter ≤ 100 DN)
- 3) Valid range for extended density calibration: 0 to 2 g/cm<sup>3</sup>, +20 to +60 °C (+68 to +140 °F)
- 4) order code for "Application package", option E1 "Extended density"

#### Temperature

±0.5 °C ± 0.005 · T °C (±0.9 °F ± 0.003 · (T - 32) °F)

## Zero point stability

DN		Zero point stability	
[mm]	[in]	[kg/h]	[lb/min]
8	$\frac{3}{8}$	0.030	0.001
15	$\frac{1}{2}$	0.200	0.007
25	1	0.540	0.019
40	$1\frac{1}{2}$	2.25	0.083
50	2	3.50	0.129
80	3	9.0	0.330
100	4	14.0	0.514
150	6	32.0	1.17
250	10	88.0	3.23

## Flow values

Flow values as turndown parameters depending on nominal diameter.

*SI units*

DN [mm]	1:1	1:10	1:20	1:50	1:100	1:500
	[kg/h]	[kg/h]	[kg/h]	[kg/h]	[kg/h]	[kg/h]
8	2 000	200	100	40	20	4
15	6 500	650	325	130	65	13
25	18 000	1 800	900	360	180	36
40	45 000	4 500	2 250	900	450	90
50	70 000	7 000	3 500	1 400	700	140
80	180 000	18 000	9 000	3 600	1 800	360
100	350 000	35 000	17 500	7 000	3 500	700
150	800 000	80 000	40 000	16 000	8 000	1 600
250	2 200 000	220 000	110 000	44 000	22 000	4 400

*US units*

DN [inch]	1:1	1:10	1:20	1:50	1:100	1:500
	[lb/min]	[lb/min]	[lb/min]	[lb/min]	[lb/min]	[lb/min]
$\frac{3}{8}$	73.50	7.350	3.675	1.470	0.735	0.147
$\frac{1}{2}$	238.9	23.89	11.95	4.778	2.389	0.478
1	661.5	66.15	33.08	13.23	6.615	1.323
$1\frac{1}{2}$	1 654	165.4	82.70	33.08	16.54	3.308
2	2 573	257.3	128.7	51.46	25.73	5.146
3	6 615	661.5	330.8	132.3	66.15	13.23
4	12 860	1 286	643.0	257.2	128.6	25.72
6	29 400	2 940	1 470	588	294	58.80
10	80 850	8 085	4 043	1 617	808.5	161.7

**Accuracy of outputs**

 The output accuracy must be factored into the measurement error if analog outputs are used; but can be ignored for fieldbus outputs (e.g. Modbus RS485, EtherNet/IP).

The outputs have the following base accuracy specifications.

*Current output*

<b>Accuracy</b>	Max. $\pm 5 \mu\text{A}$
-----------------	--------------------------

*Pulse/frequency output*

o.r. = of reading

<b>Accuracy</b>	Max. $\pm 50 \text{ ppm o.r. (over the entire ambient temperature range)}$
-----------------	----------------------------------------------------------------------------

**Repeatability**

o.r. = of reading;  $1 \text{ g/cm}^3 = 1 \text{ kg/l}$ ; T = medium temperature

**Base repeatability**

 Design fundamentals →  45

*Mass flow and volume flow (liquids)*

$\pm 0.025 \text{ % o.r. (PremiumCal)}$   
 $\pm 0.05 \text{ % o.r.}$

*Mass flow (gases)*

$\pm 0.20 \text{ % o.r.}$

*Density (liquids)*

$\pm 0.00025 \text{ g/cm}^3$

*Temperature*

$\pm 0.25 \text{ }^\circ\text{C} \pm 0.0025 \cdot T \text{ }^\circ\text{C} (\pm 0.45 \text{ }^\circ\text{F} \pm 0.0015 \cdot (T-32) \text{ }^\circ\text{F})$

**Response time**

The response time depends on the configuration (damping).

**Influence of ambient temperature**

**Current output**

o.r. = of reading

<b>Temperature coefficient</b>	Max. $\pm 0.005 \text{ % o.r./}^\circ\text{C}$
--------------------------------	------------------------------------------------

**Pulse/frequency output**

<b>Temperature coefficient</b>	No additional effect. Included in accuracy.
--------------------------------	---------------------------------------------

**Influence of medium temperature**

**Mass flow**

o.f.s. = of full scale value

If there is a difference between the temperature during zero adjustment and the process temperature, the additional measurement error of the sensors is typically  $\pm 0.0002 \text{ %o.f.s./}^\circ\text{C}$  ( $\pm 0.0001 \text{ % o. f.s./}^\circ\text{F}$ ).

The influence is reduced when the zero adjustment is performed at process temperature.

**Density**

If there is a difference between the density calibration temperature and the process temperature, the measurement error of the sensors is typically  $\pm 0.00005 \text{ g/cm}^3 / ^\circ\text{C}$  ( $\pm 0.000025 \text{ g/cm}^3 / ^\circ\text{F}$ ). Field density adjustment is possible.

Can also be used for order code for "Measuring tube material", option LA up to  $-100 \text{ }^\circ\text{C}$  ( $-148 \text{ }^\circ\text{F}$ ).

**Wide-range density specification (special density calibration)**

If the process temperature is outside the valid range ( $\rightarrow$  41) the measurement error is  $\pm 0.00005 \text{ g/cm}^3 / ^\circ\text{C}$  ( $\pm 0.000025 \text{ g/cm}^3 / ^\circ\text{F}$ )

**Extended density specification**

If the process temperature is outside the valid range ( $\rightarrow$  41) the measurement error is  $\pm 0.000025 \text{ g/cm}^3 / ^\circ\text{C}$  ( $\pm 0.0000125 \text{ g/cm}^3 / ^\circ\text{F}$ )

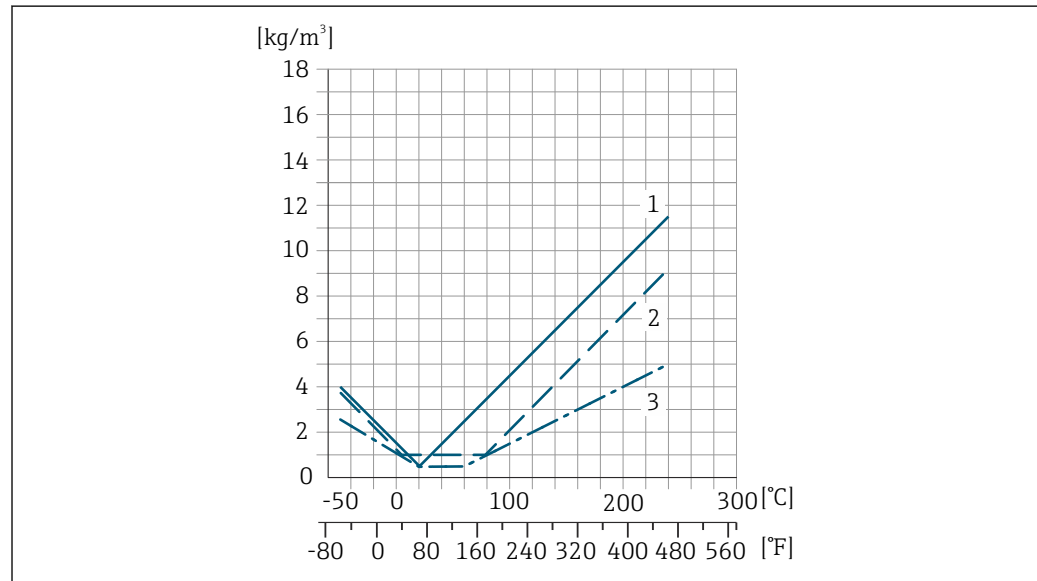

A0055953

- 1 Field density adjustment, for example at  $+20 \text{ }^\circ\text{C}$  ( $+68 \text{ }^\circ\text{F}$ )
- 2 Special density calibration
- 3 Extended density calibration

**Temperature**

$\pm 0.005 \cdot T \text{ }^\circ\text{C}$  ( $\pm 0.005 \cdot (T - 32) \text{ }^\circ\text{F}$ )

**Influence of medium pressure**

The following shows how the process pressure (gauge pressure) affects the accuracy of the mass flow.

o.r. = of reading

- It is possible to compensate for the effect by:
  - Reading in the current pressure measured value via the current input or a digital input.
  - Specifying a fixed value for the pressure in the device parameters.

Operating Instructions  $\rightarrow$  103.

DN		[% o.r./bar]	[% o.r./psi]
[mm]	[in]		
8	3/8	no influence	
15	1/2	-0.002	-0.0001
25	1	no influence	
40	1 1/2	-0.003	-0.0002
50	2	-0.008	-0.0006
80	3	-0.009	-0.0006
100	4	-0.007	-0.0005

DN		[% o.r./bar]	[% o.r./psi]
[mm]	[in]		
150	6	-0.009	-0.0006
250	10	-0.009	-0.0006

**Design fundamentals**

o.r. = of reading, o.f.s. = of full scale value

BaseAccu = base accuracy in % o.r., BaseRepeat = base repeatability in % o.r.

MeasValue = measured value; ZeroPoint = zero point stability

*Calculation of the maximum measured error as a function of the flow rate*

Flow rate	Maximum measured error in % o.r.
$\geq \frac{\text{ZeroPoint}}{\text{BaseAccu}} \cdot 100$ <small>A0021332</small>	$\pm \text{BaseAccu}$ <small>A0021339</small>
$< \frac{\text{ZeroPoint}}{\text{BaseAccu}} \cdot 100$ <small>A0021333</small>	$\pm \frac{\text{ZeroPoint}}{\text{MeasValue}} \cdot 100$ <small>A0021334</small>

*Calculation of the maximum repeatability as a function of the flow rate*

Flow rate	Maximum repeatability in % o.r.
$\geq \frac{1/2 \cdot \text{ZeroPoint}}{\text{BaseRepeat}} \cdot 100$ <small>A0021335</small>	$\pm \text{BaseRepeat}$ <small>A0021340</small>
$< \frac{1/2 \cdot \text{ZeroPoint}}{\text{BaseRepeat}} \cdot 100$ <small>A0021336</small>	$\pm 1/2 \cdot \frac{\text{ZeroPoint}}{\text{MeasValue}} \cdot 100$ <small>A0021337</small>

**Example of maximum measurement error**

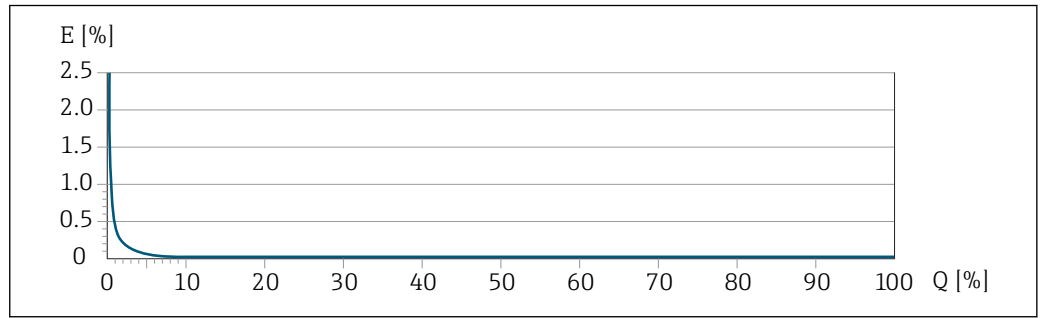

E Maximum measurement error in % o.r. (example with PremiumCal)  
 Q Flow rate in % of maximum full scale value

## Mounting

### Installation point

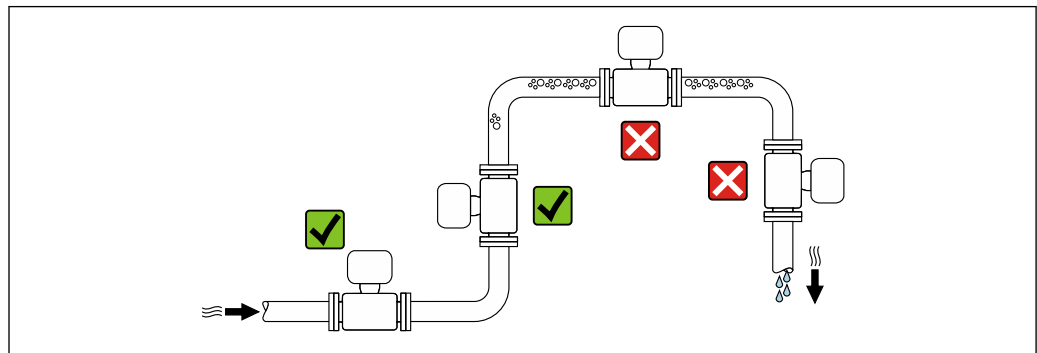

A0028772

To prevent measuring errors arising from accumulation of gas bubbles in the measuring pipe, avoid the following mounting locations in the piping:

- Highest point of a pipeline.
- Directly upstream of a free pipe outlet in a down pipe.

### Installation in down pipes

However, the following installation suggestion allows for installation in an open vertical pipeline. Pipe restrictions or the use of an orifice with a smaller cross-section than the nominal diameter prevent the sensor running empty while measurement is in progress.

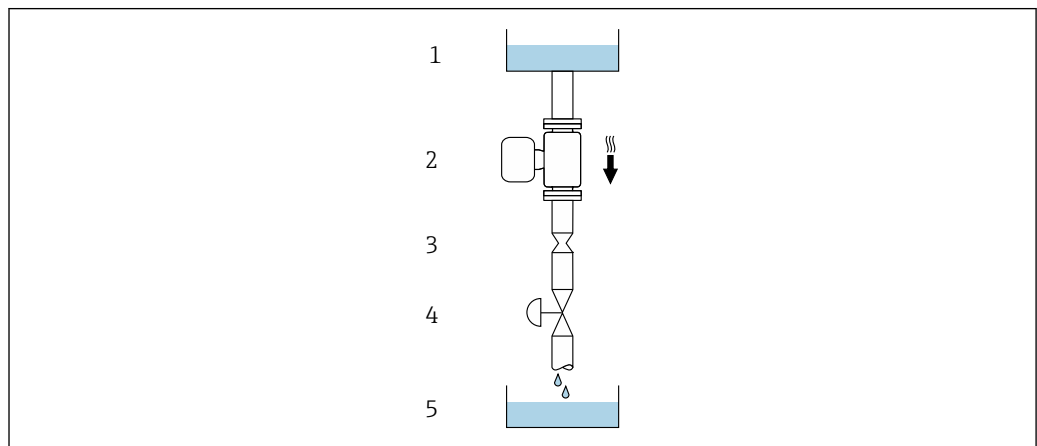

A0028773

■ 20 Installation in a down pipe (e.g. for batching applications)

- 1 Supply tank
- 2 Sensor
- 3 Orifice plate, pipe restriction
- 4 Valve
- 5 Filling vessel

DN		Ø orifice plate, pipe restriction	
[mm]	[in]	[mm]	[in]
8	3/8	6	0.24
15	1/2	10	0.40
25	1	14	0.55
40	1 1/2	22	0.87
50	2	28	1.10
80	3	50	1.97
100	4	65	2.60

DN		Ø orifice plate, pipe restriction	
[mm]	[in]	[mm]	[in]
150	6	90	3.54
250	10	150	5.91

**Orientation**

The direction of the arrow on the sensor nameplate helps you to install the sensor according to the flow direction (direction of medium flow through the piping).

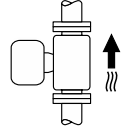
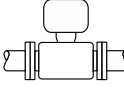
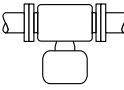
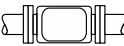
Orientation		Recommendation
<b>A</b>	Vertical orientation	 <small>A0015591</small> <input checked="" type="checkbox"/> <input checked="" type="checkbox"/> <sup>1)</sup>
<b>B</b>	Horizontal orientation, transmitter at top	 <small>A0015589</small> <input checked="" type="checkbox"/> <input checked="" type="checkbox"/> <sup>2)</sup> Exception: →  21,  47
<b>C</b>	Horizontal orientation, transmitter at bottom	 <small>A0015590</small> <input checked="" type="checkbox"/> <input checked="" type="checkbox"/> <sup>3)</sup> Exception: →  21,  47
<b>D</b>	Horizontal orientation, transmitter at side	 <small>A0015592</small> <input type="checkbox"/> <input checked="" type="checkbox"/>

- 1) This orientation is recommended to ensure self-draining.
- 2) Applications with low process temperatures may reduce the ambient temperature. To maintain the minimum ambient temperature for the transmitter, this orientation is recommended.
- 3) Applications with high process temperatures may increase the ambient temperature. To maintain the maximum ambient temperature for the transmitter, this orientation is recommended.

If a sensor is installed horizontally with a curved measuring tube, match the position of the sensor to the fluid properties.

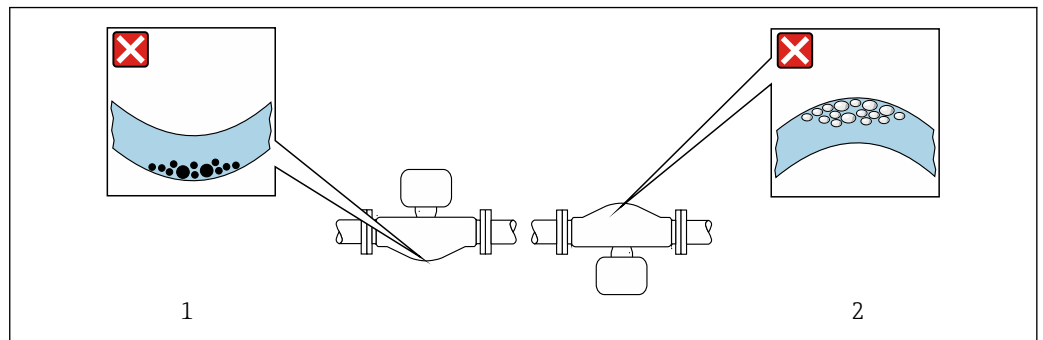

21 Orientation of sensor with curved measuring tube

- 1 Avoid this orientation for fluids with entrained solids: Risk of solids accumulating
- 2 Avoid this orientation for outgassing fluids: Risk of gas accumulating

**Inlet and outlet runs**

No special precautions need to be taken for fittings that create turbulence, such as valves, elbows or T-pieces, as long as no cavitation occurs → 57.

**Special mounting instructions**

**Drainability**

When installed vertically, the measuring tubes can be drained completely and protected against buildup.

### Hygienic compatibility

**i** When installing in hygienic applications, please refer to the information in the "Certificates and approvals/hygienic compatibility" section → 97

### Rupture disk

Process-related information: → 56.

#### **WARNING**

#### **Danger from medium escaping!**

Medium escaping under pressure can cause injury or material damage.

- ▶ Take precautions to prevent danger to persons and damage if the rupture disk is actuated.
- ▶ Observe the information on the rupture disk sticker.
- ▶ Make sure that the function and operation of the rupture disk is not impeded through the installation of the device.
- ▶ Do not use a heating jacket.
- ▶ Do not remove or damage the rupture disk.

The position of the rupture disk is indicated by a sticker affixed beside it.

The transportation guard must be removed.

The existing connecting nozzles are not intended for the purpose of rinsing or pressure monitoring, but instead serve as the mounting location for the rupture disk.

In the event of a failure of the rupture disk, a drain device can be screwed onto the internal thread of the rupture disk in order to drain off any escaping medium.

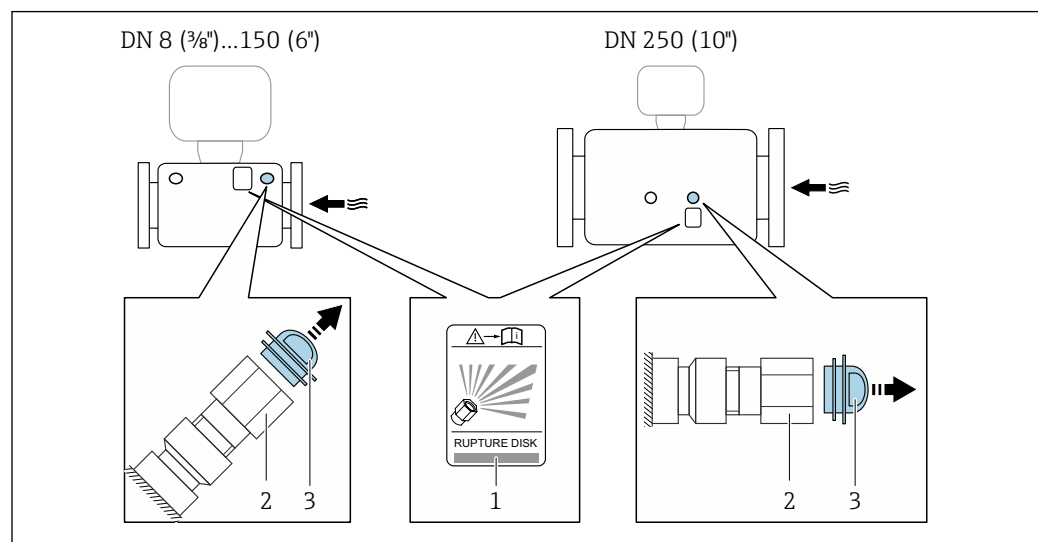

- 1 Rupture disk label
- 2 Rupture disk with 1/2" NPT internal thread and 1" width across flats
- 3 Transportation guard

For information on the dimensions, see the "Mechanical construction" section (accessories).

### Zero verification and zero adjustment

All measuring instruments are calibrated in accordance with state-of-the-art technology. Calibration takes place under reference conditions → 41. Therefore, a zero adjustment in the field is generally not required.

Experience shows that zero adjustment is advisable only in special cases:

- To achieve maximum measurement accuracy even with low flow rates.
- Under extreme process or operating conditions (e.g. very high process temperatures or very high-viscosity fluids).
- For gas applications with low pressure



For information on checking the zero point and performing a zero adjustment, see the Operating Instructions for the device.

**i** To achieve the highest possible measurement accuracy at low flow rates, the installation must protect the sensor from mechanical stresses during operation.

**Installing the Safety Barrier Promass 100**

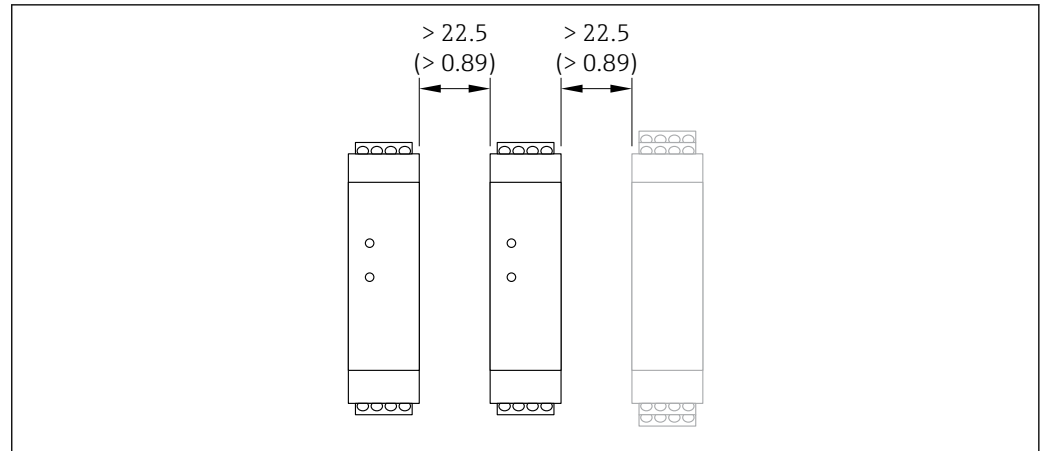

**22** Minimum distance between additional Safety Barrier Promass 100 or other modules. Engineering unit mm (in)

**Environment**

**Ambient temperature range**

<b>Measuring device</b>	<ul style="list-style-type: none"> <li>■ -40 to +60 °C (-40 to +140 °F)</li> <li>■ Order code for "Test, certificate", option JM: -50 to +60 °C (-58 to +140 °F)</li> </ul>
<b>Safety barrier Promass 100</b>	-40 to +60 °C (-40 to +140 °F)

- ▶ If operating outdoors:  
Avoid direct sunlight, particularly in warm climatic regions.

**Storage temperature**

-40 to +80 °C (-40 to +176 °F), preferably at +20 °C (+68 °F) (standard version)  
-50 to +80 °C (-58 to +176 °F) (Order code for "Test, certificate", option JM)

**Climate class**

DIN EN 60068-2-38 (test Z/AD)

**Degree of protection**

**Transmitter and sensor**

- Standard: IP66/67, Type 4X enclosure, suitable for pollution degree 4
- With the order code for "Sensor options", option CM: IP69 can also be ordered
- When the housing is open: IP20, Type 1 enclosure, suitable for pollution degree 2
- Display module: IP20, Type 1 enclosure, suitable for pollution degree 2

**Safety Barrier Promass 100**  
IP20

**Shock and vibration resistance**

**Vibration sinusoidal, in accordance with IEC 60068-2-6**

- 2 to 8.4 Hz, 7.5 mm peak
- 8.4 to 2 000 Hz, 2 g peak

**Vibration broad-band random, according to IEC 60068-2-64**

- 10 to 200 Hz, 0.01 g<sup>2</sup>/Hz
- 200 to 2 000 Hz, 0.003 g<sup>2</sup>/Hz
- Total: 2.70 g rms

**Shock half-sine, according to IEC 60068-2-27**

6 ms 50 g

**Rough handling shocks according to IEC 60068-2-31****Internal cleaning**

- CIP cleaning
- SIP cleaning

**Options**

- Oil- and grease-free version for wetted parts, without declaration  
Order code for "Service", option HA <sup>1)</sup>
- Oil- and grease-free version for wetted parts as per IEC/TR 60877-2.0 and BOC 50000810-4, with declaration  
Order code for "Service", option HB <sup>1)</sup>

**Electromagnetic compatibility (EMC)**

- Depends on the communication protocol:
  - As per IEC/EN 61326 and NAMUR Recommendation 21 (NE 21)
  - As per IEC/EN 61000-6-2 and IEC/EN 61000-6-4
  - As per IEC/EN 61326
- Complies with emission limits for industry as per EN 55011 (Class A)
- Device version with PROFIBUS DP: Complies with emission limits for industry as per EN 50170 Volume 2, IEC 61784



The following applies for PROFIBUS DP: If baud rates > 1.5 MBaud, an EMC cable entry must be used and the cable shield must continue as far as the terminal wherever possible.



Details are provided in the Declaration of Conformity.



This unit is not intended for use in residential environments and cannot guarantee adequate protection of the radio reception in such environments.

## Process

**Medium temperature range**

Standard version	-50 to +150 °C (-58 to +302 °F)	Order code for "Measuring tube mat., wetted surface", option HA, SA, SB, SC
Extended temperature version	-50 to +240 °C (-58 to +464 °F)	Order code for "Measuring tube mat., wetted surface", option SD, SE, SF, TH

**Pressure-temperature ratings**

The following pressure/temperature diagrams apply to all pressure-bearing parts of the device and not just the process connection. The diagrams show the maximum permissible medium pressure depending on the specific medium temperature.



Pressure-temperature ratings with the +151 to +240 °C (+304 to +464 °F) temperature range only for the extended temperature version of the measuring device.

1) The cleaning refers to the measuring instrument only. Any accessories supplied are not cleaned.

**Flange similar to EN 1092-1 (DIN 2501)**

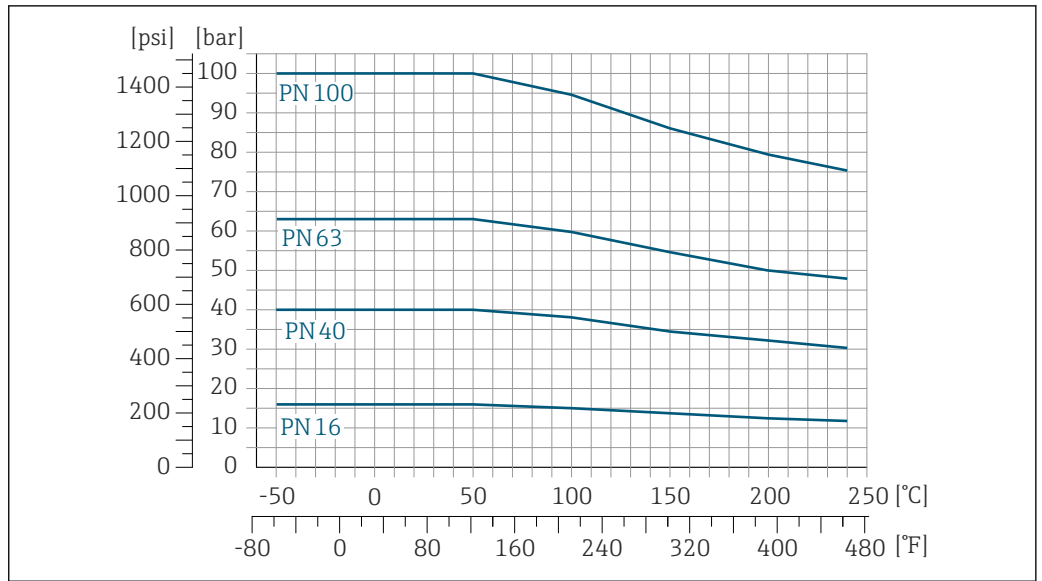

23 With flange material 1.4404 (F316/F316L), Alloy C22

A0034658-EN

**Flange similar to ASME B16.5**

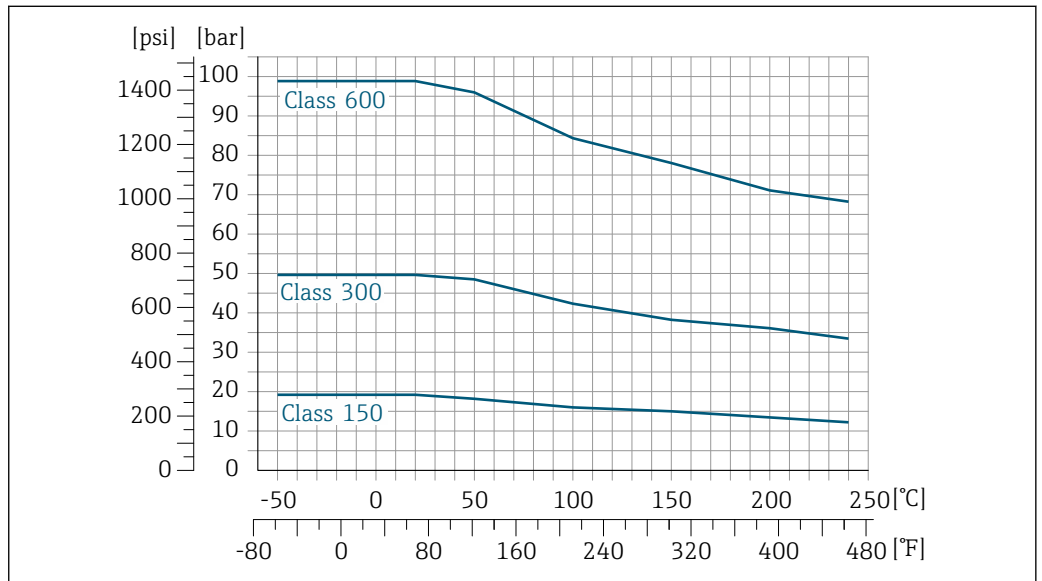

24 With flange material 1.4404 (F316/F316L)

A0034659-EN

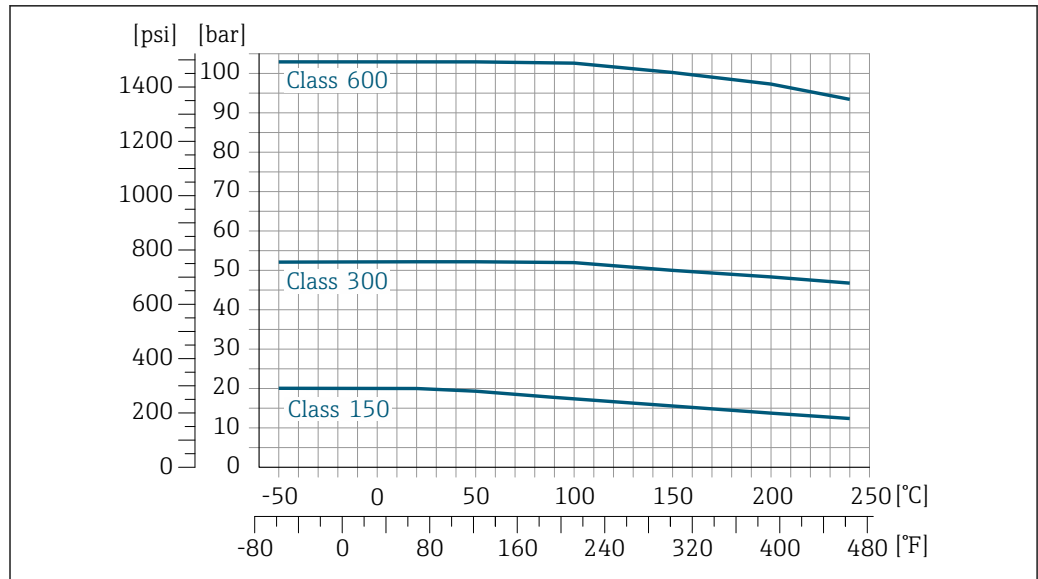

A0034660-EN

25 With flange material Alloy C22

**Flange JIS B2220**

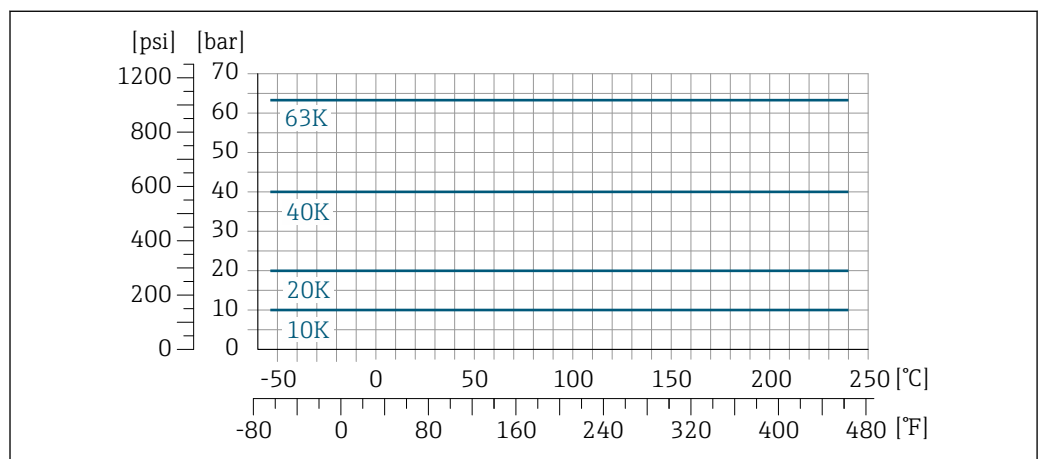

A0034665-EN

26 With flange material 1.4404 (F316/F316L), Alloy C22

**Flange DIN 11864-2 Form A**

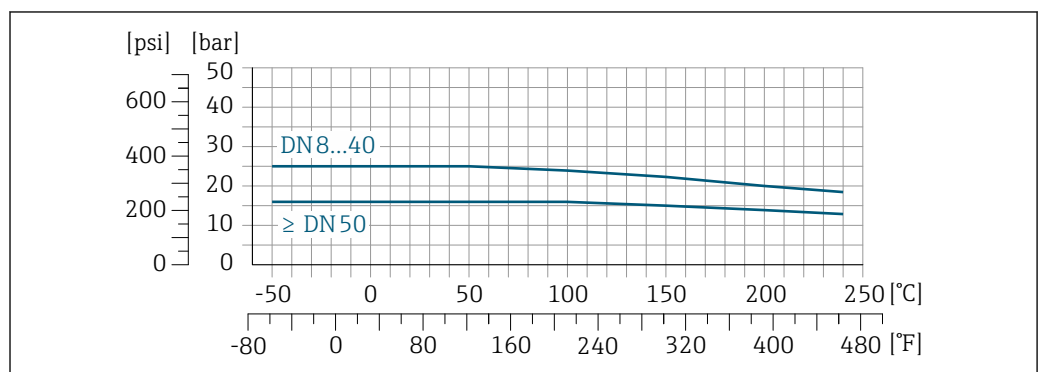

A0028782-EN

27 With connection material 1.4404 (316/316L)

**Lap joint flange according to EN 1092-1 (DIN 2501)**

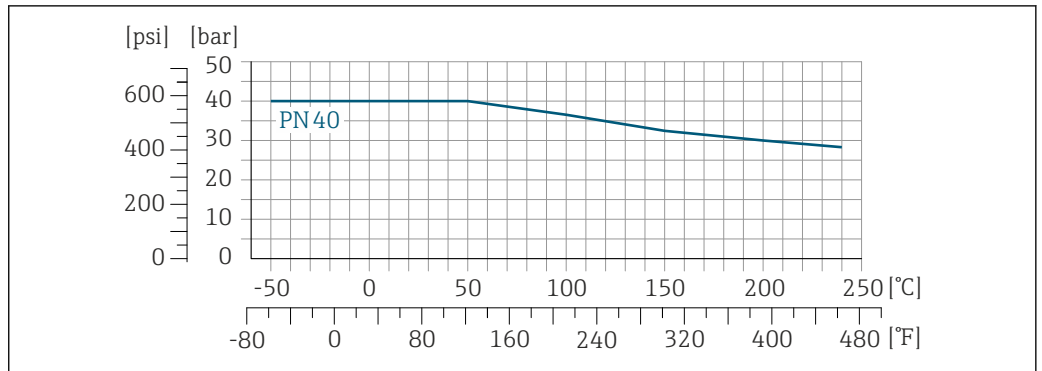

28 With flange material 1.4301 (F304); wetted parts Alloy C22

**Lap joint flange according to ASME B16.5**

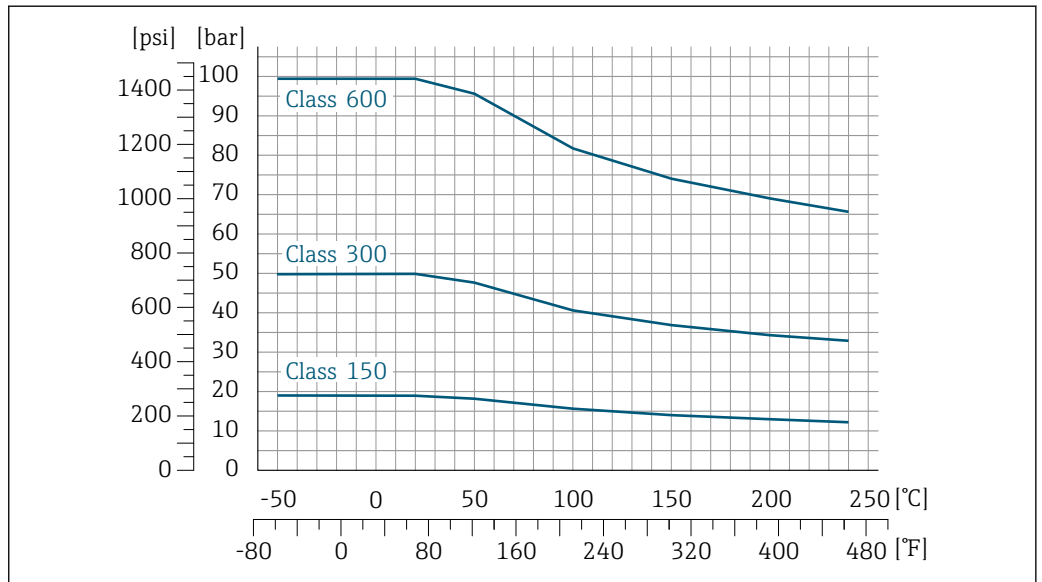

29 With flange material 1.4301 (F304); wetted parts Alloy C22

**Lap joint flange JIS B2220**

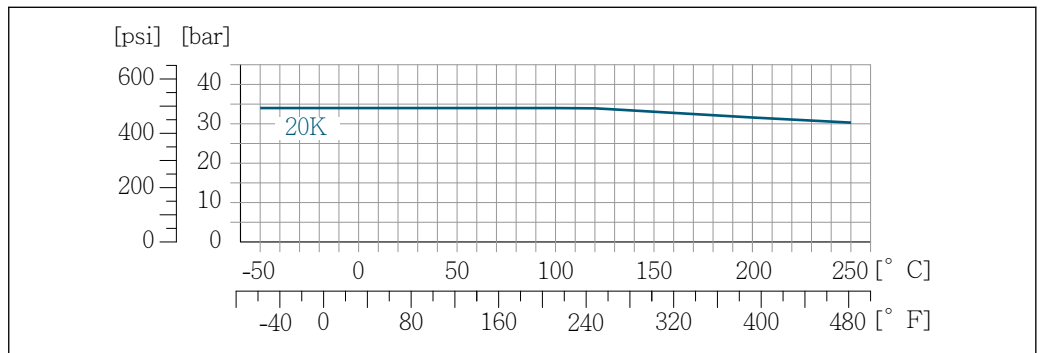

30 With flange material 1.4301 (F304); wetted parts Alloy C22

**Thread DIN 11851**

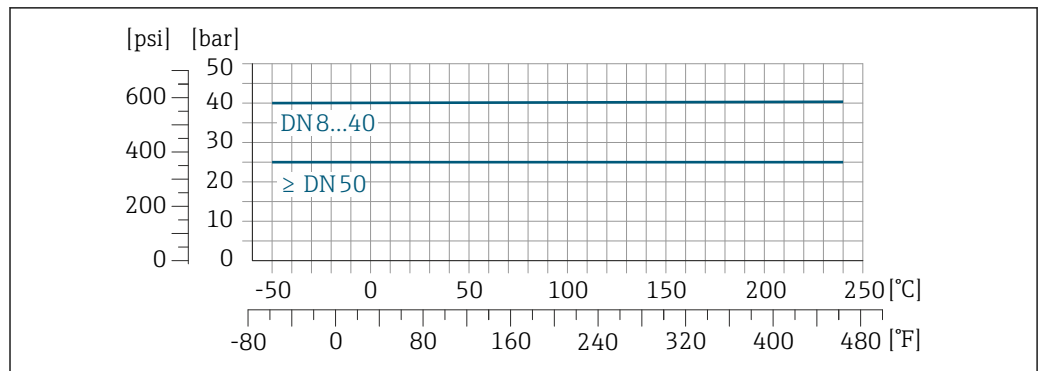

A0028794-EN

31 With connection material 1.4404 (316/316L)

DIN 11851 allows for applications up to +140 °C (+284 °F) if suitable sealing materials are used. Please take this into account when selecting seals and counterparts, as these components can limit the pressure and temperature range.

**Thread DIN 11864-1 Form A**

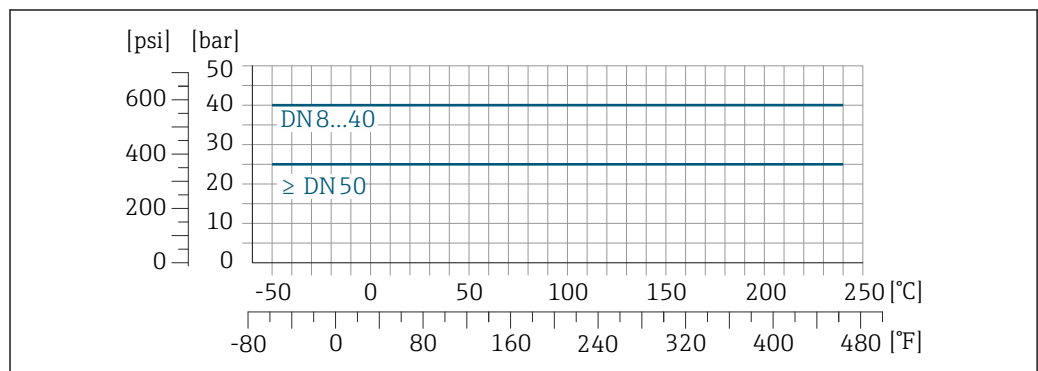

A0028798-EN

32 With connection material 1.4404 (316/316L)

**Thread ISO 2853**

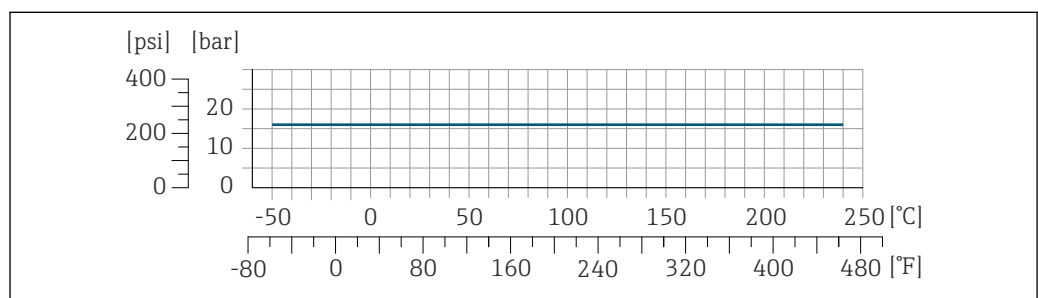

A0028799-EN

33 With connection material 1.4404 (316/316L)

**Thread SMS 1145**

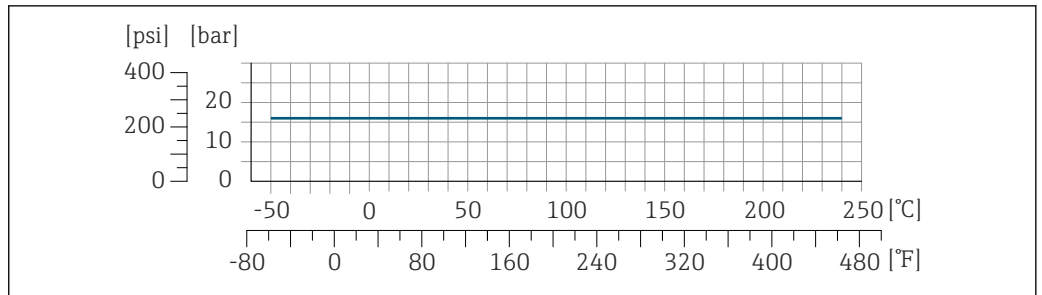

A0028800-EN

34 With connection material 1.4404 (316/316L)

SMS 1145 allows for applications up to 16 bar (232 psi) if suitable sealing materials are used. Please take this into account when selecting seals and counterparts, as these components can limit the pressure and temperature range.

**VCO**

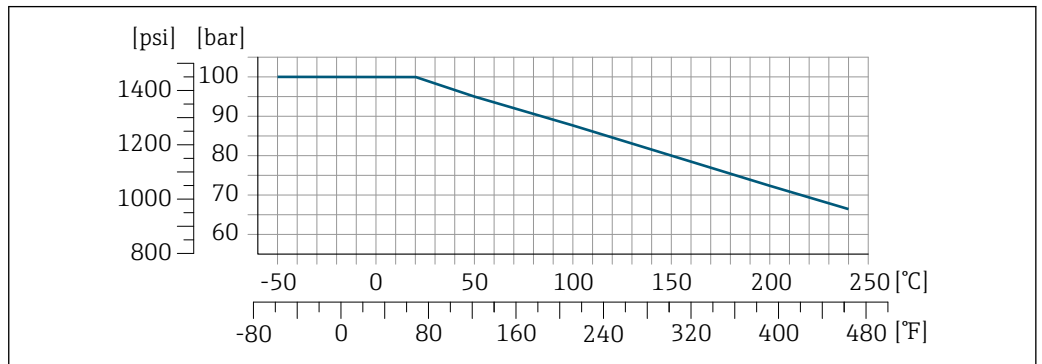

A0028801-EN

35 With connection material 1.4404 (316/316L)

**Tri-Clamp**

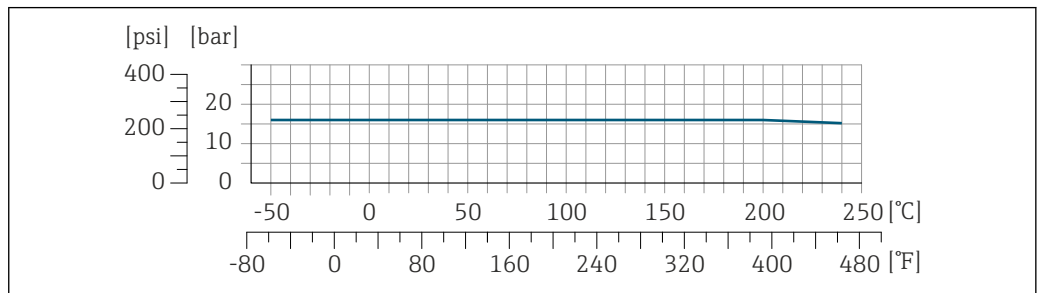

A0032216-EN

The clamp connections are suitable up to a maximum pressure of 16 bar (232 psi). Please observe the operating limits of the clamp and seal used as they can be over 16 bar (232 psi). The clamp and seal are not included in the scope of supply.

**Sensor housing**

For standard versions with the temperature range -50 to +150 °C (-58 to +302 °F), the sensor housing is filled with dry nitrogen gas and protects the electronics and mechanics inside.

For all other temperature versions the sensor housing is filled with dry inert gas.

**i** If a measuring tube fails (e.g. due to process characteristics like corrosive or abrasive fluids), the fluid will initially be contained by the sensor housing.

In the event of a tube failure, the pressure level inside the sensor housing will rise according to the operating process pressure. If the user judges that the sensor housing burst pressure does not provide an adequate safety margin, the device can be fitted with a rupture disk. This prevents excessively high pressure from forming inside the sensor housing. Therefore, the use of a rupture disk is strongly recommended in applications involving high gas pressures, and particularly in applications in which the process pressure is greater than 2/3 of the sensor housing burst pressure.

If there is a need to drain the leaking medium into a discharge device, the sensor should be fitted with a rupture disk. Connect the discharge to the additional threaded connection →  77.

If the sensor is to be purged with gas (gas detection), it should be equipped with purge connections.

 Do not open the purge connections unless the containment can be filled immediately with a dry, inert gas. Use only low pressure to purge.

Maximum pressure:

- DN 08 to 150 (3/8 to 6"): 5 bar (72.5 psi)
- DN 250 (10"):
  - Medium temperature ≤ 100 °C (212 °F): 5 bar (72.5 psi)
  - Medium temperature > 100 °C (212 °F): 3 bar (43.5 psi)

### Burst pressure of the sensor housing

The following sensor housing burst pressures are only valid for standard devices and/or devices equipped with closed purge connections (not opened/as delivered).

If a device fitted with purge connections (order code for "Sensor option", option CH "Purge connection") is connected to the purge system, the maximum pressure is determined by the purge system itself or by the device, depending on which component has the lower pressure classification.

If the device is fitted with a rupture disk (order code for "Sensor option", option CA "Rupture disk"), the rupture disk trigger pressure is decisive.

The sensor housing burst pressure refers to a typical internal pressure which is reached prior to mechanical failure of the sensor housing and which was determined during type testing. The corresponding type test declaration can be ordered with the device (order code for "Additional approval", option LN "Sensor housing burst pressure, type test").

DN		Sensor housing burst pressure	
[mm]	[in]	[bar]	[psi]
8	3/8	400	5800
15	1/2	350	5070
25	1	280	4060
40	1 1/2	260	3770
50	2	180	2610
80	3	120	1740
100	4	95	1370
150	6	75	1080
250	10	50	720

For information on the dimensions: see the "Mechanical construction" section

### Rupture disk

To increase the level of safety, a device version with a rupture disk with a trigger pressure of 10 to 15 bar (145 to 217.5 psi) can be used (order code for "Sensor option", option CA "rupture disk").

The use of rupture disks cannot be combined with the separately available heating jacket.

For information on the dimensions: see the "Mechanical construction" section (accessories) →  77



**Flow limit**

Select the nominal diameter by optimizing between the required flow range and permissible pressure loss.

**i** For an overview of the full scale values for the measuring range, see the "Measuring range" section → 9

- The minimum recommended full scale value is approx. 1/20 of the maximum full scale value
- In most applications, 20 to 50 % of the maximum full scale value can be considered ideal
- A low full scale value must be selected for abrasive media (such as liquids with entrained solids): flow velocity < 1 m/s (< 3 ft/s).
- For gas measurement the following rules apply:
  - The flow velocity in the measuring tubes should not exceed half the sound velocity (0.5 Mach).
  - The maximum mass flow depends on the density of the gas: formula

**i** To calculate the flow limit, use the *Applicator* sizing tool → 102

**Pressure loss**

**i** To calculate the pressure loss, use the *Applicator* sizing tool → 102

Promass F with reduced pressure loss: order code for "Sensor option", option CE "Reduced pressure loss"

**Static pressure**

It is important that cavitation does not occur, or that gases entrained in the liquids do not outgas. This is prevented by means of a sufficiently high static pressure.

For this reason, the following mounting locations are recommended:

- At the lowest point in a vertical pipe
- Downstream from pumps (no danger of vacuum)

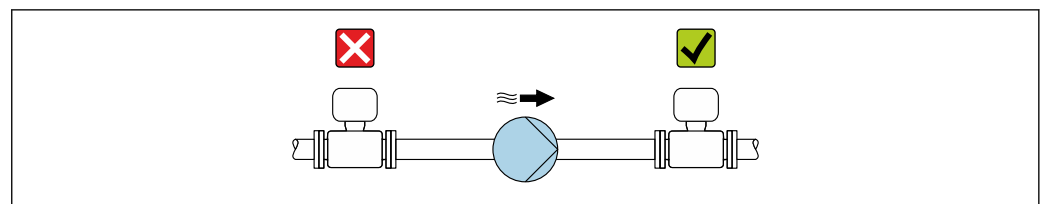

A0028777

**Thermal insulation**

In the case of some fluids, it is important to keep the heat radiated from the sensor to the transmitter to a low level. A wide range of materials can be used for the required insulation.

The following device versions are recommended for versions with thermal insulation:

- Version with extended neck for insulation:  
Order code for "Sensor option", option CG with an extended neck length of 105 mm (4.13 in).
- Extended temperature version:  
Order code for "Measuring tube material", option SD, SE, SF or TH with an extended neck length of 105 mm (4.13 in).

**NOTICE**

**Electronics overheating on account of thermal insulation!**

- ▶ Recommended orientation: horizontal orientation, transmitter housing pointing downwards.
- ▶ Do not insulate the transmitter housing .
- ▶ Maximum permissible temperature at the lower end of the transmitter housing: 80 °C (176 °F)
- ▶ Regarding thermal insulation with an exposed extended neck: We advise against insulating the extended neck to ensure optimal heat dissipation.

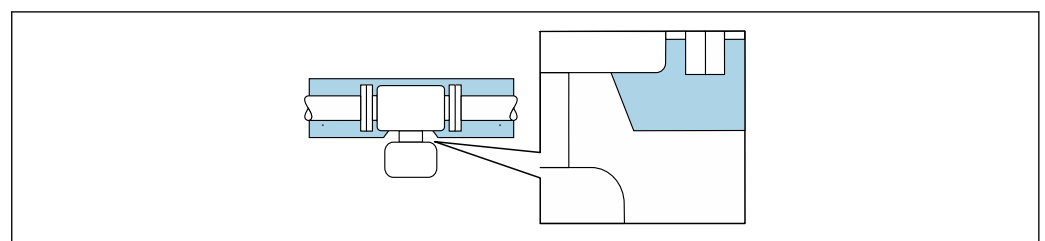

A0034391

36 Thermal insulation with exposed extended neck

---

**Heating**

Some fluids require suitable measures to avoid loss of heat at the sensor.

**Heating options**

- Electrical heating, e.g. with electric band heaters <sup>2)</sup>
- Via pipes carrying hot water or steam
- Via heating jackets



Heating jackets for the sensors can be ordered as accessories from Endress+Hauser → 101.

**NOTICE****Danger of overheating when heating**

- ▶ Ensure that the temperature at the lower end of the transmitter housing does not exceed 80 °C (176 °F).
- ▶ Ensure that sufficient convection takes place at the transmitter neck.
- ▶ Ensure that a sufficiently large area of the transmitter neck remains exposed. The uncovered part serves as a radiator and protects the electronics from overheating and excessive cooling.
- ▶ When using in potentially explosive atmospheres, observe the information in the device-specific Ex documentation. For detailed information on the temperature tables, see the separate document entitled "Safety Instructions" (XA) for the device.
- ▶ Consider the "830 ambient temperature too high" and "832 electronics temperature too high" process diagnostics if overheating cannot be ruled out based on a suitable system design.

---

**Vibrations**

The high oscillation frequency of the measuring tubes ensures that the correct operation of the measuring system is not influenced by plant vibrations.

---

2) The use of parallel electric band heaters is generally recommended (bidirectional electricity flow). Particular considerations must be made if a single-wire heating cable is to be used. Additional information is provided in the document EA01339D "Installation instructions for electrical trace heating systems" → 104

## Mechanical construction

Dimensions in SI units

Compact version

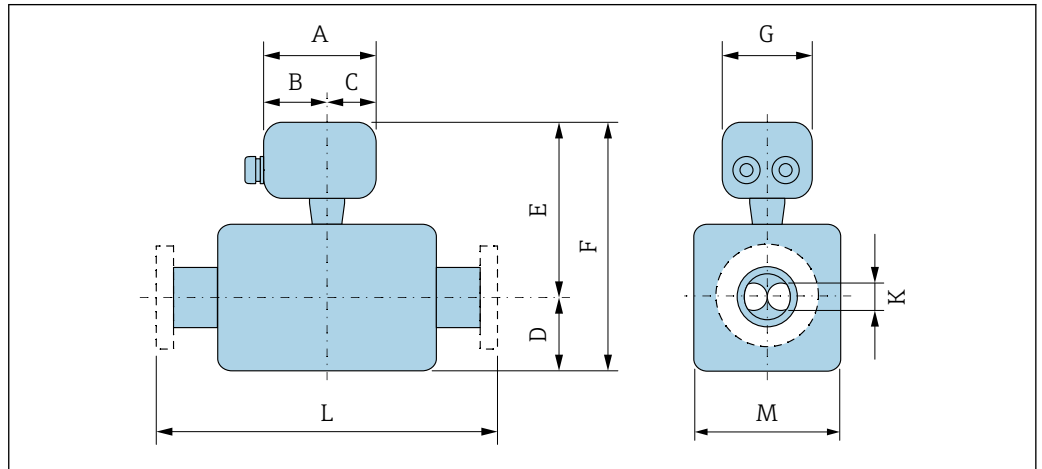

A0033787

Order code for "Housing", option A "Compact, aluminum, coated"

DN	<sup>1)</sup> A	<sup>1)</sup> B	C	D	E <sup>2) 3)</sup>	F <sup>2) 3)</sup>	G	K	L	M
[mm]	[mm]	[mm]	[mm]	[mm]	[mm]	[mm]	[mm]	[mm]	[mm]	[mm]
8	148	94	54	75	185	260	136	5.35	<sup>4)</sup>	70
15	148	94	54	75	185	260	136	8.31	<sup>4)</sup>	70
25	148	94	54	75	185	260	136	12.0	<sup>4)</sup>	70
40	148	94	54	105	189.5	294.5	136	17.6	<sup>4)</sup>	79
50	148	94	54	141	199.5	340.5	136	26.0	<sup>4)</sup>	99
80	148	94	54	200	219.5	419.5	136	40.5	<sup>4)</sup>	139
100	148	94	54	254	238	492	136	51.2	<sup>4)</sup>	176
150	148	94	54	378	259	637	136	68.9	<sup>4)</sup>	218
250	148	94	54	548	302.5	850.5	136	102.3	<sup>4)</sup>	305

- 1) Depending on the cable gland used: values up to + 30 mm
- 2) With order code for "Sensor option", option CG or order code for "Measuring tube material", option SD, SE, SF, TH: values + 70 mm
- 3) If using a display, order code for "Display; Operation", option B: values + 28 mm
- 4) Depends on the particular process connection → 61

Order code for "Housing", option B "Compact, hygienic, stainless"

DN	<sup>1)</sup> A	<sup>1)</sup> B	C	D	E <sup>2) 3)</sup>	F <sup>2) 3)</sup>	G	K	L	M
[mm]	[mm]	[mm]	[mm]	[mm]	[mm]	[mm]	[mm]	[mm]	[mm]	[mm]
8	137	78	59	75	180	255	134	5.35	<sup>4)</sup>	70
15	137	78	59	75	180	255	134	8.31	<sup>4)</sup>	70
25	137	78	59	75	180	255	134	12.0	<sup>4)</sup>	70
40	137	78	59	105	184.5	289.5	134	17.6	<sup>4)</sup>	79
50	137	78	59	141	194.5	335.5	134	26.0	<sup>4)</sup>	99
80	137	78	59	200	214.5	414.5	134	40.5	<sup>4)</sup>	139
100	137	78	59	254	233	487	134	51.2	<sup>4)</sup>	176

DN	<sup>1)</sup> A	<sup>1)</sup> B	C	D	E <sup>2) 3)</sup>	F <sup>2) 3)</sup>	G	K	L	M
[mm]	[mm]	[mm]	[mm]	[mm]	[mm]	[mm]	[mm]	[mm]	[mm]	[mm]
150	137	78	59	378	254	632	134	68.9	<sup>4)</sup>	218
250	137	78	59	548	297.5	845.5	134	102.3	<sup>4)</sup>	305

- 1) Depending on the cable gland used: values up to + 30 mm
- 2) With order code for "Sensor option", option CG or order code for "Measuring tube material", option SD, SE, SF, TH: values + 70 mm
- 3) If using a display, order code for "Display; Operation", option B: values + 28 mm
- 4) Depends on the particular process connection →  61

Order code for "Housing", option C "Ultra-compact, hygienic, stainless"

DN	<sup>1)</sup> A	<sup>1)</sup> B	C	D	F <sup>2) 3)</sup>	F <sup>2) 3)</sup>	G	K	L	M
[mm]	[mm]	[mm]	[mm]	[mm]	[mm]	[mm]	[mm]	[mm]	[mm]	[mm]
8	124	68	56	75	180	255	112	5.35	<sup>4)</sup>	70
15	124	68	56	75	180	255	112	8.31	<sup>4)</sup>	70
25	124	68	56	75	180	255	112	12.0	<sup>4)</sup>	70
40	124	68	56	105	184.5	289.5	112	17.6	<sup>4)</sup>	79
50	124	68	56	141	194.5	335.5	112	26.0	<sup>4)</sup>	99
80	124	68	56	200	214.5	414.5	112	40.5	<sup>4)</sup>	139
100	124	68	56	254	233	487	112	51.2	<sup>4)</sup>	176
150	124	68	56	378	254	632	112	68.9	<sup>4)</sup>	218
250	124	68	56	548	297.5	845.5	112	102.3	<sup>4)</sup>	305

- 1) Depending on the cable gland used: values up to + 30 mm
- 2) With order code for "Sensor option", option CG or order code for "Measuring tube material", option SD, SE, SF, TH: values + 70 mm
- 3) If using a display, order code for "Display; Operation", option B: values + 14 mm
- 4) Depends on the particular process connection →  61

**Flange connections**

Fixed flange EN 1092-1, ASME B16.5, JIS B2220

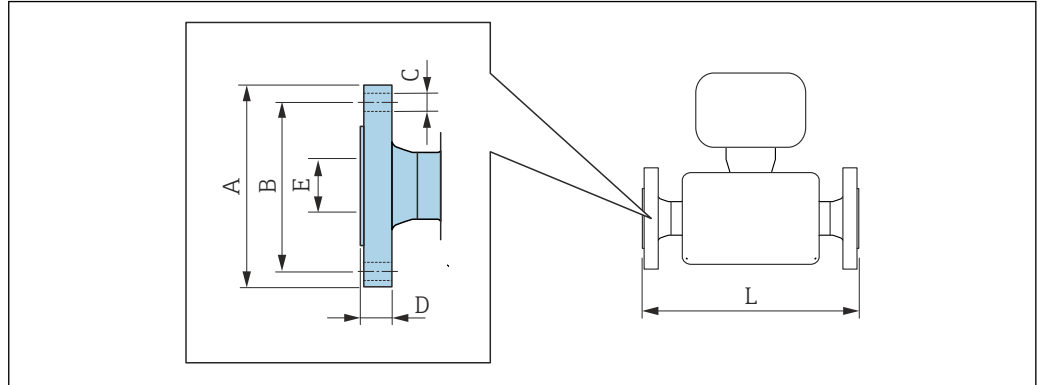

A0015621

- i** Length tolerance for dimension L in mm:
  - DN ≤ 100: +1.5/-2.0
  - DN ≥ 150: ±3.5

<b>Flange similar to EN 1092-1 (DIN 2501): PN16</b> <b>1.4404 (F316/F316L): order code for "Process connection", option D1S</b> <b>Alloy C22: order code for "Process connection", option D1C</b>						
<b>Flange with groove similar to EN 1092-1 Form D (DIN 2512N): PN16</b> <b>1.4404 (F316/F316L): order code for "Process connection", option D5S</b> <b>Alloy C22: order code for "Process connection", option D5C</b>						
DN [mm]	A [mm]	B [mm]	C [mm]	D [mm]	E [mm]	L [mm]
100	220	180	8 × Ø18	20	107.1	1 127/1 400 <sup>1)</sup>
150	285	240	8 × Ø22	22	159.3	1 330/1 700 <sup>1)</sup>
250	405	355	12 × Ø26	26	260.4	1 775
Surface roughness (flange): EN 1092-1 Form B1 (DIN 2526 Form C), Ra 3.2 to 12.5 µm						

1) Installed length in accordance with NAMUR recommendation NE 132 optionally available (order code for "Process connection", option D1N or D5N (with groove))

<b>Flange similar to EN 1092-1 (DIN 2501): PN16 with reduction in nominal diameter</b> <b>1.4404 (F316/F316L)</b>								
DN [mm]	Reduction to DN [mm]	Order code "Process connection", Option	A [mm]	B [mm]	C [mm]	D [mm]	E [mm]	L [mm]
100	80	DHS	220	180	8 × Ø18	20	107.1	874
150	100	DJS	285	240	8 × Ø22	22	159.3	1 167
200	150	DLS	340	295	12 × Ø22	24	206.5	1 461
Surface roughness (flange): EN 1092-1 Form B1 (DIN 2526 Form C), Ra 3.2 to 12.5 µm								

<b>Flange similar to EN 1092-1 (DIN 2501): PN 40</b>						
1.4404 (F316/F316L): order code for "Process connection", option D2S						
Alloy C22: order code for "Process connection", option D2C						
<b>Flange with groove similar to EN 1092-1 Form D (DIN 2512N): PN 40</b>						
1.4404 (F316/F316L): order code for "Process connection", option D6S						
Alloy C22: order code for "Process connection", option D6C						
DN [mm]	A [mm]	B [mm]	C [mm]	D [mm]	E [mm]	L [mm]
8 <sup>1)</sup>	95	65	4 × Ø14	16	17.3	370/510 <sup>2)</sup>
15	95	65	4 × Ø14	16	17.3	404/510 <sup>2)</sup>
25	115	85	4 × Ø14	18	28.5	440/600 <sup>2)</sup>
40	150	110	4 × Ø18	18	43.1	550
50	165	125	4 × Ø18	20	54.5	715/715 <sup>2)</sup>
80	200	160	8 × Ø18	24	82.5	840/915 <sup>2)</sup>
100	235	190	8 × Ø22	24	107.1	1 127
150	300	250	8 × Ø26	28	159.3	1 370
250	450	385	12 × Ø33	38	258.8	1 845
Surface roughness (flange): EN 1092-1 Form B1 (DIN 2526 Form C), Ra 3.2 to 12.5 µm						

- 1) DN 8 with DN 15 flanges as standard  
 2) Installed length in accordance with NAMUR recommendation NE 132 optionally available (order code for "Process connection", option D2N or D6N (with groove))

<b>Flange similar to EN 1092-1 (DIN 2501): PN 40 (with DN 25 flanges)</b>						
1.4404 (F316/F316L): order code for "Process connection", option R2S						
DN [mm]	A [mm]	B [mm]	C [mm]	D [mm]	E [mm]	L [mm]
8	115	85	4 × Ø14	18	28.5	440
15	115	85	4 × Ø14	18	28.5	440
Surface roughness (flange): EN 1092-1 Form B1 (DIN 2526 Form C), Ra 3.2 to 12.5 µm						

<b>Flange similar to EN 1092-1 (DIN 2501): PN 40 with reduction in nominal diameter</b>								
1.4404 (F316/F316L)								
DN [mm]	Reduction to DN [mm]	Order code "Process connection", Option	A [mm]	B [mm]	C [mm]	D [mm]	E [mm]	L [mm]
50	40	DFS	165	125	4 × Ø18	20	54.5	555
80	50	DGS	200	160	8 × Ø18	24	82.5	840
100	80	DIS	235	190	8 × Ø22	24	107.1	874
150	100	DKS	300	250	8 × Ø26	28	159.3	1 167
200	150	DMS	375	320	12 × Ø30	34	206.5	1 461
Surface roughness (flange): EN 1092-1 Form B1 (DIN 2526 Form C), Ra 3.2 to 12.5 µm								

**Flange similar to EN 1092-1 (DIN 2501): PN 63**  
**1.4404 (F316/F316L):** order code for "Process connection", option D3S  
**Alloy C22:** order code for "Process connection", option D3C

**Flange with groove similar to EN 1092-1 Form D (DIN 2512N): PN 63**  
**1.4404 (F316/F316L):** order code for "Process connection", option D7S  
**Alloy C22:** order code for "Process connection", option D7C

DN [mm]	A [mm]	B [mm]	C [mm]	D [mm]	E [mm]	L [mm]
50	180	135	4 × Ø22	26	54.5	724
80	215	170	8 × Ø22	28	81.7	875
100	250	200	8 × Ø26	30	106.3	1127
150	345	280	8 × Ø33	36	157.1	1410
250	470	400	12 × Ø36	46	255.4	1885

Surface roughness (flange):  
 EN 1092-1 Form B1 (DIN 2526 Form C), Ra 3.2 to 12.5 µm EN 1092-1 Form B2 (DIN 2526 Form E), Ra 0.8 to 3.2 µm

**Flange similar to EN 1092-1 (DIN 2501): PN 100**  
**1.4404 (F316/F316L):** order code for "Process connection", option D4S  
**Alloy C22:** order code for "Process connection", option D4C

**Flange with groove similar to EN 1092-1 Form D (DIN 2512N): PN 100**  
**1.4404 (F316/F316L):** order code for "Process connection", option D8S  
**Alloy C22:** order code for "Process connection", option D8C

DN [mm]	A [mm]	B [mm]	C [mm]	D [mm]	E [mm]	L [mm]
8 <sup>1)</sup>	105	75	4 × Ø14	20	17.3	400
15	105	75	4 × Ø14	20	17.3	420
25	140	100	4 × Ø18	24	28.5	470
40	170	125	4 × Ø22	26	42.5	590
50	195	145	4 × Ø26	28	53.9	740
80	230	180	8 × Ø26	32	80.9	885
100	265	210	8 × Ø30	36	104.3	1127
150	355	290	12 × Ø33	44	154.0	1450

Surface roughness (flange): EN 1092-1 Form B2 (DIN 2526 Form E), Ra 0.8 to 3.2 µm

1) DN 8 with DN 15 flanges as standard

**Flange similar to EN 1092-1 (DIN 2501): PN 100**  
**Alloy C22:** order code for "Process connection", option D4C

**Flange with groove similar to EN 1092-1 Form D (DIN 2512N): PN 100**  
**Alloy C22:** order code for "Process connection", option D8C

DN [mm]	A [mm]	B [mm]	C [mm]	D [mm]	E [mm]	L [mm]
250	505	430	12 × Ø39	60	248.0	1949

Surface roughness (flange): EN 1092-1 Form B2 (DIN 2526 Form E), Ra 0.8 to 3.2 µm

<b>Flange similar to ASME B16.5: Class 150</b> 1.4404 (F316/F316L): order code for "Process connection", option AAS Alloy C22: order code for "Process connection", option AAC						
DN [mm]	A [mm]	B [mm]	C [mm]	D [mm]	E [mm]	L [mm]
8 <sup>1)</sup>	90	60.3	4 × Ø15.7	11.2	15.7	370
15	90	60.3	4 × Ø15.7	11.2	15.7	404
25	110	79.4	4 × Ø15.7	14.2	26.7	440
40	125	98.4	4 × Ø15.9	15.9	40.9	550
50	150	120.7	4 × Ø19.1	19.1	52.6	715
80	190	152.4	4 × Ø19.1	23.9	78.0	840
100	230	190.5	8 × Ø19.1	23.9	102.4	1127
150	280	241.3	8 × Ø22.4	25.4	154.2	1398
250	405	362	12 × Ø25.4	30.2	254.5	1832
Surface roughness (flange): Ra 3.2 to 6.3 µm						

1) DN 8 with DN 15 flanges as standard

<b>Flange similar to ASME B16.5: Class 150 with reduction in nominal diameter</b> 1.4404 (F316/F316L)								
DN [mm]	Reduction to DN [mm]	Order code "Process connection", Option	A [mm]	B [mm]	C [mm]	D [mm]	E [mm]	L [mm]
50	40	AHS	150	120.7	4 × Ø19.1	19.1	52.6	550
80	50	AJS	190	152.4	4 × Ø19.1	23.9	78.0	720
100	80	ALS	230	190.5	8 × Ø19.1	23.9	102.4	874
150	100	ANS	280	241.3	8 × Ø22.4	25.4	154.2	1167
200	150	APS	345	298.5	8 × Ø22.4	29	202.7	1461
Surface roughness (flange): Ra 3.2 to 6.3 µm								

<b>Flange similar to ASME B16.5: Class 300</b> 1.4404 (F316/F316L): order code for "Process connection", option ABS Alloy C22: order code for "Process connection", option ABC						
DN [mm]	A [mm]	B [mm]	C [mm]	D [mm]	E [mm]	L [mm]
8 <sup>1)</sup>	95	66.7	4 × Ø15.7	14.2	15.7	370
15	95	66.7	4 × Ø15.7	14.2	15.7	404
25	125	88.9	4 × Ø19.1	17.5	26.7	440
40	155	114.3	4 × Ø22.3	20.6	40.9	550
50	165	127	8 × Ø19.1	22.3	52.6	715
80	210	168.3	8 × Ø22.3	28.4	78.0	840
100	255	200	8 × Ø22.3	31.7	102.4	1127
150	320	269.9	12 × Ø22.3	36.5	154.2	1417
250	445	387.4	16 × Ø28.4	47.4	254.5	1863
Surface roughness (flange): Ra 3.2 to 6.3 µm						

1) DN 8 with DN 15 flanges as standard



Flange similar to ASME B16.5: Class 300 with reduction in nominal diameter 1.4404 (F316/F316L)								
DN [mm]	Reduction to DN [mm]	Order code "Process connection", Option	A [mm]	B [mm]	C [mm]	D [mm]	E [mm]	L [mm]
50	40	AIS	165	127	8 × Ø19.1	22.3	52.6	615
80	50	AKS	210	168.3	8 × Ø22.3	28.4	78.0	732
100	80	AMS	255	200	8 × Ø22.3	31.7	102.4	894
150	100	AOS	320	269.9	12 × Ø22.3	36.5	154.2	1187
200	150	AQS	380	330.2	12 × Ø25.4	41.7	202.7	1461
Surface roughness (flange): Ra 3.2 to 6.3 µm								

Flange similar to ASME B16.5: Class 600 1.4404 (F316/F316L): order code for "Process connection", option ACS Alloy C22: order code for "Process connection", option ACC						
DN [mm]	A [mm]	B [mm]	C [mm]	D [mm]	E [mm]	L [mm]
8 <sup>1)</sup>	95	66.7	4 × Ø15.7	20.6	13.9	400
15	95	66.7	4 × Ø15.7	20.6	13.9	420
25	125	88.9	4 × Ø19.1	23.9	24.3	490
40	155	114.3	4 × Ø22.3	28.7	38.1	600
50	165	127	8 × Ø19.1	31.8	49.2	742
80	210	168.3	8 × Ø22.3	38.2	73.7	900
100	275	215.9	8 × Ø25.4	48.4	97.3	1157
150	355	292.1	12 × Ø28.4	47.8	154.2	1467
250	510	431.8	16 × Ø35.1	69.9	254.5	1946
Surface roughness (flange): Ra 3.2 to 6.3 µm						

1) DN 8 with DN 15 flanges as standard

Flange JIS B2220: 10K 1.4404 (F316/F316L): order code for "Process connection", option NDS Alloy C22: order code for "Process connection", option NDC						
DN [mm]	A [mm]	B [mm]	C [mm]	D [mm]	E [mm]	L [mm]
50	155	120	4 × Ø19	16	50	715
80	185	150	8 × Ø19	18	80	832
100	210	175	8 × Ø19	18	100	1127
150	280	240	8 × Ø23	22	150	1354
250	400	355	12 × Ø25	24	250	1775
Surface roughness (flange): Ra 3.2 to 6.3 µm						

<b>Flange JIS B2220: 20K</b>						
1.4404 (F316/F316L): order code for "Process connection", option NES						
Alloy C22: order code for "Process connection", option NEC						
DN [mm]	A [mm]	B [mm]	C [mm]	D [mm]	E [mm]	L [mm]
8 <sup>1)</sup>	95	70	4 × Ø15	14	15	370
15	95	70	4 × Ø15	14	15	404
25	125	90	4 × Ø19	16	25	440
40	140	105	4 × Ø19	18	40	550
50	155	120	8 × Ø19	18	50	715
80	200	160	8 × Ø23	22	80	832
100	225	185	8 × Ø23	24	100	1127
150	305	260	12 × Ø25	28	150	1386
250	430	380	12 × Ø27	34	250	1845
Surface roughness (flange): Ra 1.6 to 3.2 µm						

1) DN 8 with DN 15 flanges as standard

<b>Flange JIS B2220: 40K</b>						
1.4404 (F316/F316L): order code for "Process connection", option NGS						
Alloy C22: order code for "Process connection", option NGC						
DN [mm]	A [mm]	B [mm]	C [mm]	D [mm]	E [mm]	L [mm]
8 <sup>1)</sup>	115	80	4 × Ø19	20	15	400
15	115	80	4 × Ø19	20	15	425
25	130	95	4 × Ø19	22	25	485
40	160	120	4 × Ø23	24	38	600
50	165	130	8 × Ø19	26	50	760
80	210	170	8 × Ø23	32	75	890
100	250	205	8 × Ø25	36	100	1167
150	355	295	12 × Ø33	44	150	1498
Surface roughness (flange): Ra 1.6 to 3.2 µm						

1) DN 8 with DN 15 flanges as standard

<b>Flange JIS B2220: 63K</b>						
1.4404 (F316/F316L): order code for "Process connection", option NHS						
Alloy C22: order code for "Process connection", option NHC						
DN [mm]	A [mm]	B [mm]	C [mm]	D [mm]	E [mm]	L [mm]
8 <sup>1)</sup>	120	85	4 × Ø19	23	12	420
15	120	85	4 × Ø19	23	12	440
25	140	100	4 × Ø23	27	22	494
40	175	130	4 × Ø25	32	35	620
50	185	145	8 × Ø23	34	48	775
80	230	185	8 × Ø25	40	73	915
100	270	220	8 × Ø27	44	98	1167

<b>Flange JIS B2220: 63K</b> <b>1.4404 (F316/F316L): order code for "Process connection", option NHS</b> <b>Alloy C22: order code for "Process connection", option NHC</b>						
DN [mm]	A [mm]	B [mm]	C [mm]	D [mm]	E [mm]	L [mm]
150	365	305	12 × Ø33	54	146	1528
Surface roughness (flange): Ra 1.6 to 3.2 µm						

- 1) DN 8 with DN 15 flanges as standard

## Fixed flange DIN 11864-2

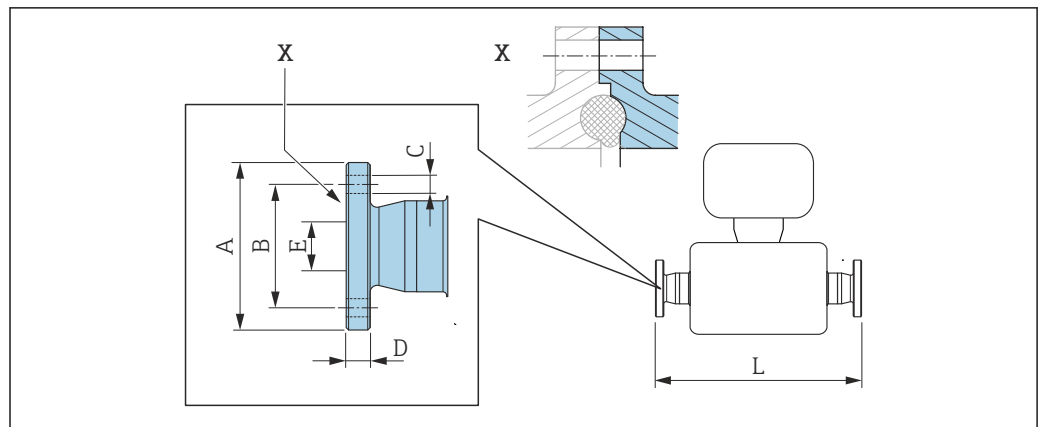

A0015627

37 Detail X: Asymmetrical process connection; the part shown in blue is provided by the supplier.

**i** Length tolerance for dimension L in mm:  
+1.5 / -2.0

**Flange DIN11864-2 Form A, for pipe according to DIN11866 series A, flange with notch 1.4404 (316/316L)**

Order code for "Process connection", option KCS

DN [mm]	A [mm]	B [mm]	C [mm]	D [mm]	E [mm]	L [mm]
8 <sup>1)</sup>	54	37	4 × Ø9	10	10	387
15	59	42	4 × Ø9	10	16	418
25	70	53	4 × Ø9	10	26	454
40	82	65	4 × Ø9	10	38	560
50	94	77	4 × Ø9	10	50	720
80	133	112	8 × Ø11	12	81	900
100	159	137	8 × Ø11	14	100	1127

3A version available: order code for "Additional approval", option LP in conjunction with  
 Ra ≤ 0.76 µm: order code for "Measuring tube material", option SB, SE, SJ, SL or  
 Ra ≤ 0.38 µm: order code for "Measuring tube material", option SC, SF, SK, SM  
 Ra ≤ 0.38 µm electropolished: order code for "Measuring tube material", option BC, BG

1) DN 8 with DN 10 flanges as standard

Lap joint flange EN 1092-1, ASME B16.5, JIS B2220

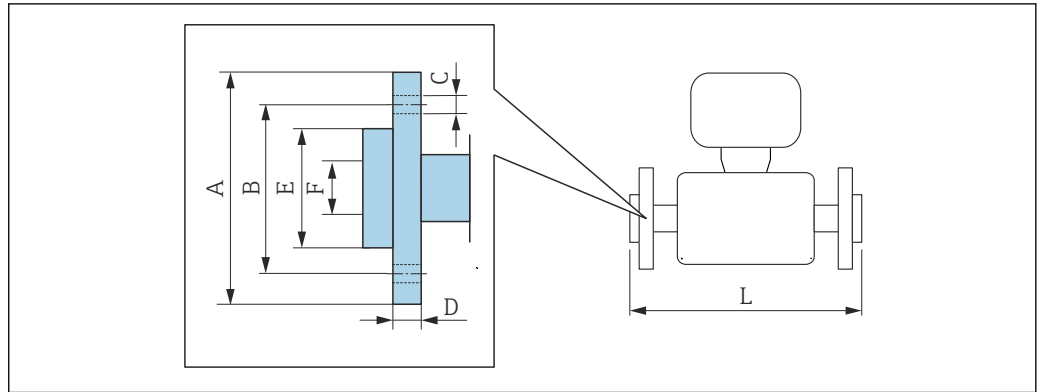

A002221

 Length tolerance for dimension L in mm:  
+1.5 / -2.0

**Lap joint flange similar to EN 1092-1 Form D: PN 40**

1.4301 (F304), wetted parts Alloy C22

Order code for "Process connection", option DAC

DN [mm]	A [mm]	B [mm]	C [mm]	D [mm]	E [mm]	F [mm]	L [mm]	L <sub>diff</sub> <sup>1)</sup> [mm]
8 <sup>2)</sup>	95	65	4 × Ø14	14.5	45	17.3	370	0
15	95	65	4 × Ø14	14.5	45	17.3	404	0
25	115	85	4 × Ø14	16.5	68	28.5	444	+4
40	150	110	4 × Ø18	21	88	43.1	560	+10
50	165	125	4 × Ø18	23	102	54.5	719	+4
80	200	160	8 × Ø18	29	138	82.5	848	+8
100	235	190	8 × Ø22	34	162	107.1	1 131	+4

Surface roughness (flange): Ra 3.2 to 12.5 µm

- 1) Difference to installed length of the welding neck flange (order code for "Process connection", option D2C)
- 2) DN 8 with DN 15 flanges as standard

**Lap joint flange similar to ASME B16.5: Class 150**

1.4301 (F304), wetted parts Alloy C22

Order code for "Process connection", option ADC

DN [mm]	A [mm]	B [mm]	C [mm]	D [mm]	E [mm]	F [mm]	L [mm]	L <sub>diff</sub> <sup>1)</sup> [mm]
8 <sup>2)</sup>	90	60.3	4 × Ø 15.7	15	35.1	15.7	370	0
15	90	60.3	4 × Ø 15.7	15	35.1	15.7	404	0
25	110	79.4	4 × Ø 15.7	16	50.8	26.7	440	0
40	125	98.4	4 × Ø 15.7	15.9	73.2	40.9	550	0
50	150	120.7	4 × Ø 19.1	19	91.9	52.6	715	0
80	190	152.4	4 × Ø 19.1	22.3	127.0	78.0	840	0
100	230	190.5	8 × Ø 19.1	26	157.2	102.4	1 127	0

Surface roughness (flange): Ra 3.2 to 12.5 µm

- 1) Difference to installed length of the welding neck flange (order code for "Process connection", option AAC)
- 2) DN 8 with DN 15 flanges as standard

<b>Lap joint flange similar to ASME B16.5: Class 300</b>								
1.4301 (F304), wetted parts Alloy C22								
Order code for "Process connection", option AEC								
DN [mm]	A [mm]	B [mm]	C [mm]	D [mm]	E [mm]	F [mm]	L [mm]	L <sub>diff</sub> <sup>1)</sup> [mm]
8 <sup>2)</sup>	95	66.7	4 × Ø 15.7	16.5	35.1	15.7	376	+6
15	95	66.7	4 × Ø 15.7	16.5	35.1	15.7	406	+2
25	125	88.9	4 × Ø 19.1	21.0	50.8	26.7	450	+10
40	155	114.3	4 × Ø 22.3	23.0	73.2	40.9	564	+14
50	165	127	8 × Ø 19.1	25.5	91.9	52.6	717	+2
80	210	168.3	8 × Ø 22.3	31.0	127.0	78.0	852.6	+12.6
100	255	200	8 × Ø 22.3	32.0	157.2	102.4	1 139	+12
Surface roughness (flange): Ra 3.2 to 12.5 µm								

- 1) Difference to installed length of the welding neck flange (order code for "Process connection", option ABC)  
 2) DN 8 with DN 15 flanges as standard

<b>Lap joint flange similar to ASME B16.5: Class 600</b>								
1.4301 (F304), wetted parts Alloy C22								
Order code for "Process connection", option AFC								
DN [mm]	A [mm]	B [mm]	C [mm]	D [mm]	E [mm]	F [mm]	L [mm]	L <sub>diff</sub> <sup>1)</sup> [mm]
8 <sup>2)</sup>	95	66.7	4 × Ø 15.7	17.0	35.1	13.9	400	0
15	95	66.7	4 × Ø 15.7	17.0	35.1	13.9	420	0
25	125	88.9	4 × Ø 19.1	21.5	50.8	24.3	490	0
40	155	114.3	4 × Ø 22.3	25.0	73.2	38.1	600	0
50	165	127	8 × Ø 19.1	28.0	91.9	49.2	742	0
80	210	168.3	8 × Ø 22.3	35.0	127.0	73.7	900	0
100	275	215.9	8 × Ø 25.4	44.0	157.2	97.3	1 167	+10
Surface roughness (flange): Ra 3.2 to 12.5 µm								

- 1) Difference to installed length of the welding neck flange (order code for "Process connection", option ACC)  
 2) DN 8 with DN 15 flanges as standard

<b>Lap joint flange JIS B2220: 20K</b>								
1.4301 (F304), wetted parts Alloy C22								
Order code for "Process connection", option NIC								
DN [mm]	A [mm]	B [mm]	C [mm]	D [mm]	E [mm]	F [mm]	L [mm]	L <sub>diff</sub> <sup>1)</sup> [mm]
8 <sup>2)</sup>	95	70	4 × Ø 15	14	51	15	370	0
15	95	70	4 × Ø 15	14	51	15	404	0
25	125	90	4 × Ø 19	18.5	67	25	440	0
40	140	105	4 × Ø 19	18.5	81	40	550	0
50	155	120	8 × Ø 19	23	96	50	715	0
80	200	160	8 × Ø 23	29	132	80	844	+12
100	225	185	8 × Ø 23	29	160	100	1 127	0
Surface roughness (flange): Ra 3.2 to 12.5 µm								

- 1) Difference to installed length of the welding neck flange (order code for "Process connection", option NEC)  
 2) DN 8 with DN 15 flanges as standard

**Clamp connections**

*Tri-Clamp*

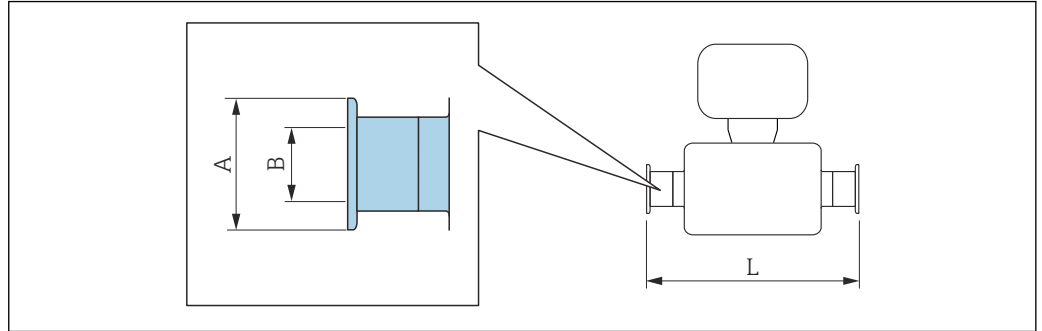

A0015625

 Length tolerance for dimension L in mm:  
+1.5 / -2.0

<b>Tri-Clamp (½"), for pipe according to DIN 11866 series C</b>				
<b>1.4404 (316/316L)</b>				
<i>Order code for "Process connection", option FDW</i>				
DN [mm]	Clamp [in]	A [mm]	B [mm]	L [mm]
8	½	25.0	9.5	367
15	½	25.0	9.5	398

3-A version available: order code for "Additional approval", option LP in conjunction with  
 Ra ≤ 0.76 µm: order code for "Measuring tube material", option SB, SE, SJ, SL or  
 Ra ≤ 0.38 µm: order code for "Measuring tube material", option SC, SF, SK, SM  
 Ra ≤ 0.38 µm electropolished: order code for "Measuring tube material", option BC, BG

<b>Tri-Clamp (≥ 1"), for pipe according to DIN 11866 series C</b>				
<b>1.4404 (316/316L)</b>				
<i>Order code for "Process connection", option FTS</i>				
DN [mm]	Clamp [in]	A [mm]	B [mm]	L [mm]
8	1	50.4	22.1	367
15	1	50.4	22.1	398
25	1	50.4	22.1	434
40	1½	50.4	34.8	560
50	2	63.9	47.5	720
80	3	90.9	72.9	900
100	4	118.9	97.4	1127

3-A version available: order code for "Additional approval", option LP in conjunction with  
 Ra ≤ 0.76 µm: order code for "Measuring tube material", option SB, SE, SJ, SL or  
 Ra ≤ 0.38 µm: order code for "Measuring tube material", option SC, SF, SK, SM  
 Ra ≤ 0.38 µm electropolished: order code for "Measuring tube material", option BC, BG

## Threaded couplings

Threaded adapter DIN 11851, DIN11864-1, SMS 1145

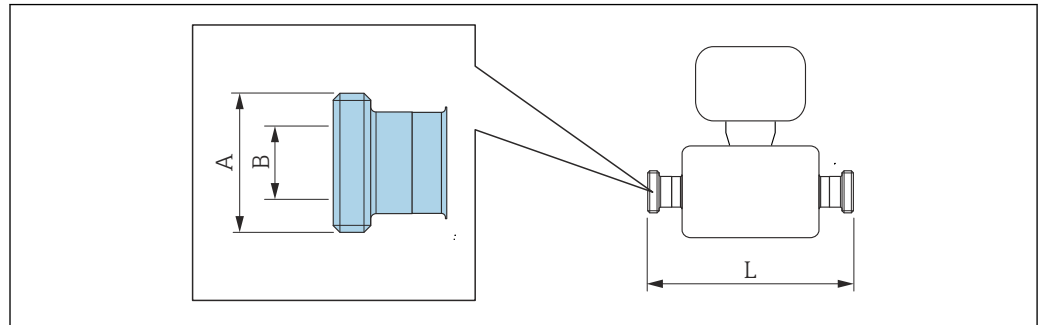

A0015628

**i** Length tolerance for dimension L in mm:  
+1.5 / -2.0

Threaded adapter DIN 11851, for pipe according to DIN11866 series A 1.4404 (316/316L) Order code for "Process connection", option FMW			
DN [mm]	A [in]	B [mm]	L [mm]
8	Rd 34 × 1/8	16	367
15	Rd 34 × 1/8	16	398
25	Rd 52 × 1/6	26	434
40	Rd 65 × 1/6	38	560
50	Rd 78 × 1/6	50	720
80	Rd 110 × 1/4	81	900
100	Rd 130 × 1/4	100	1127

3-A version available: order code for "Additional approval", option LP in conjunction with  
Ra ≤ 0.76 µm: order code for "Measuring tube material", option SB, SE, SJ, SL

Threaded adapter DIN11864-1 Form A, for pipe according to DIN11866 series A 1.4404 (316/316L) Order code for "Process connection", option FLW			
DN [mm]	A [in]	B [mm]	L [mm]
8	Rd 28 × 1/8	10	367
15	Rd 34 × 1/8	16	398
25	Rd 52 × 1/8	26	434
40	Rd 65 × 1/6	38	560
50	Rd 78 × 1/6	50	720
80	Rd 110 × 1/4	81	900
100	Rd 130 × 1/4	100	1127

3-A version available: order code for "Additional approval", option LP in conjunction with  
Ra ≤ 0.76 µm: order code for "Measuring tube material", option SB, SE, SJ, SL or  
Ra ≤ 0.38 µm: order code for "Measuring tube material", option SC, SF, SK, SM  
Ra ≤ 0.38 µm electropolished: order code for "Measuring tube material", option BC, BG



<b>Threaded adapter SMS 1145</b> <b>1.4404 (316/316L)</b> <i>Order code for "Process connection", option SCS</i>			
DN [mm]	A [in]	B [mm]	L [mm]
8	Rd 40 × 1/6	22.6	367
15	Rd 40 × 1/6	22.6	398
25	Rd 40 × 1/6	22.6	434
40	Rd 60 × 1/6	35.6	560
50	Rd 70 × 1/6	48.6	720
80	Rd 98 × 1/6	72.9	900
100	Rd 132 × 1/6	97.6	1 127

3-A version available: order code for "Additional approval", option LP in conjunction with  
Ra ≤ 0.76 µm: order code for "Measuring tube material", option SB, SE, SJ, SL

## Threaded adapter ISO 2853

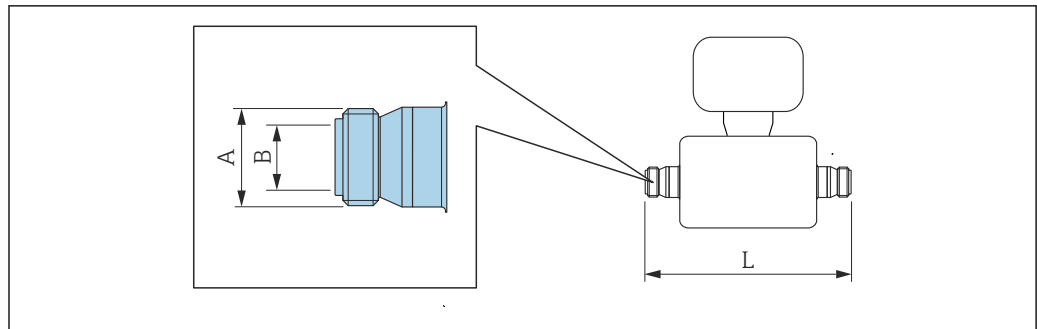

A0015623

**i** Length tolerance for dimension L in mm:  
+1.5 / -2.0

Threaded adapter ISO 2853, for pipe according to ISO 2037 1.4404 (316/316L) Order code for "Process connection", option JSF			
DN [mm]	A <sup>1)</sup> [mm]	B [mm]	L [mm]
8	37.13	22.6	367
15	37.13	22.6	398
25	37.13	22.6	434
40	52.68	35.6	560
50	64.16	48.6	720
80	91.19	72.9	900
100	118.21	97.6	1 127

3-A version available: order code for "Additional approval", option LP in conjunction with  
 $R_a \leq 0.76 \mu\text{m}$ : order code for "Measuring tube material", option SB, SE, SJ, SL or  
 $R_a \leq 0.38 \mu\text{m}$ : order code for "Measuring tube material", option SC, SF, SK, SM  
 $R_a \leq 0.38 \mu\text{m}$  electropolished: order code for "Measuring tube material", option BC, BG

1) Max. thread diameter according to ISO 2853 Annex A

VCO

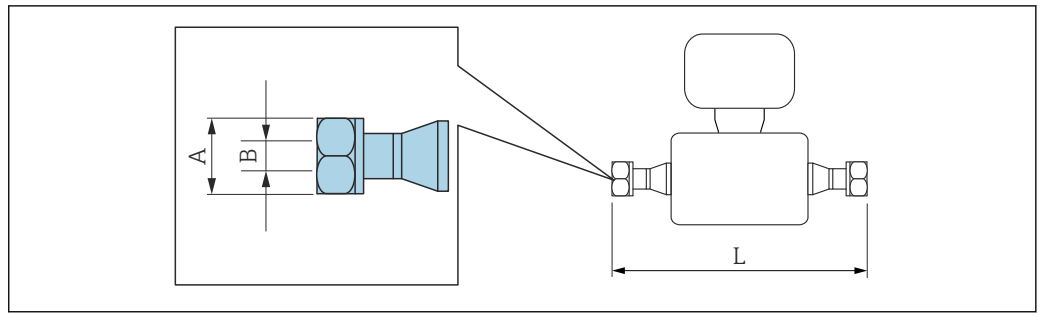

A0015624

**i** Length tolerance for dimension L in mm:  
+1.5 / -2.0

8-VCO-4 (½") 1.4404 (316/316L) Order code for "Process connection", option CVS			
DN [mm]	A [in]	B [mm]	L [mm]
8	AF 1	10.2	390

12-VCO-4 (¾") 1.4404 (316/316L) Order code for "Process connection", option CWS			
DN [mm]	A [in]	B [mm]	L [mm]
15	AF 1½	15.7	430

**Safety Barrier Promass 100**

Top-hat rail EN 60715:

- TH 35 x 7.5
- TH 35 x 15

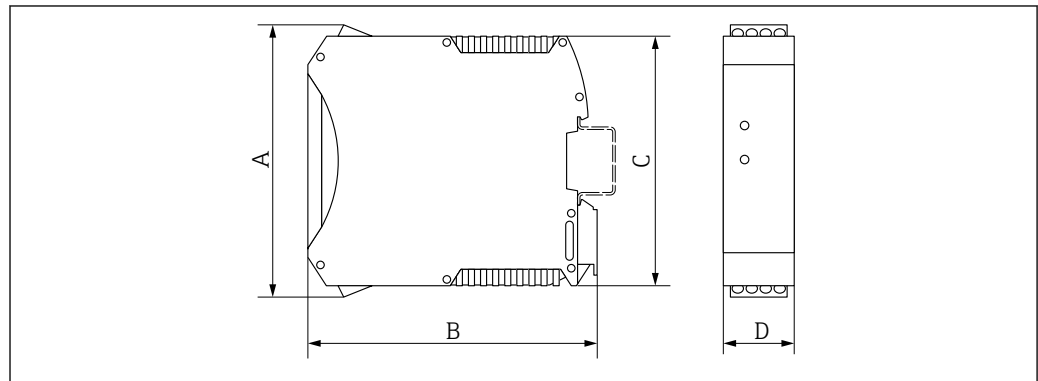

A0016777

A	B	C	D
[mm]	[mm]	[mm]	[mm]
108	114.5	99	22.5

Accessories

Rupture disk/purge connections

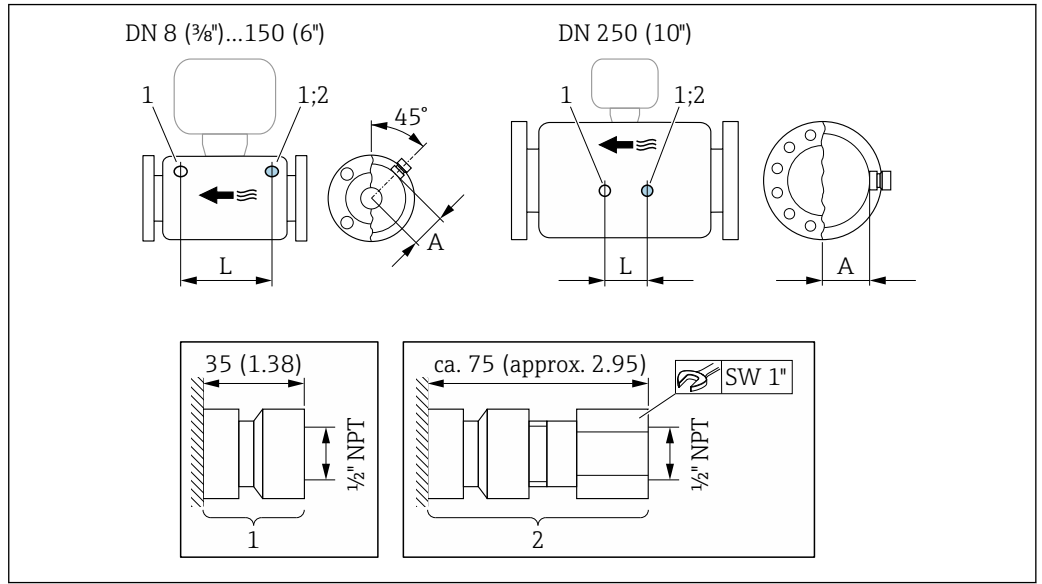

A0028914

38

- 1 Connection nipple for purge connections: order code for "Sensor options", option CH "Purge connection"
- 2 Connection nipple with rupture disk: order code for "Sensor option", option CA "Rupture disk"

DN	A	L
[mm]	[mm]	[mm]
8	62	216
15	62	220
25	62	260
40	67	310
50	79	452
80	101	560
100	120	684
150	141	880
250	182	380

## Dimensions in US units

## Compact version

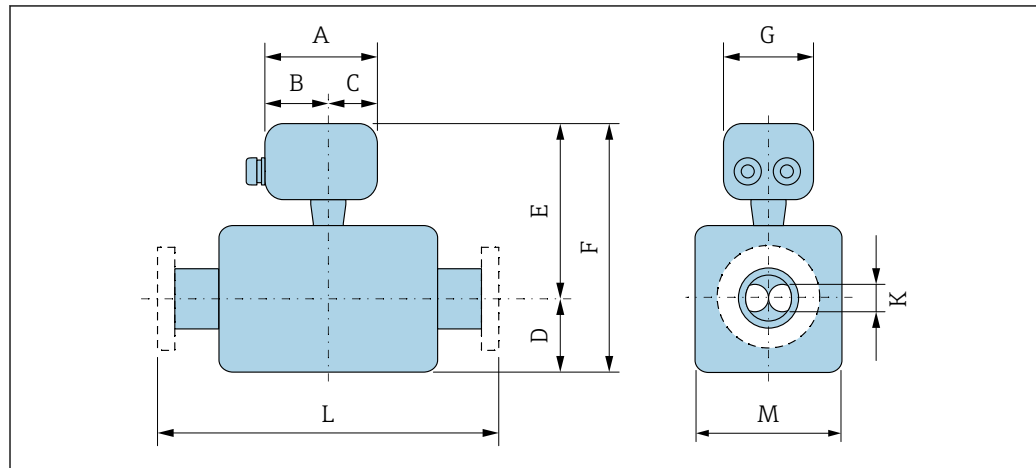

A0033787

Order code for "Housing", option A "Compact, aluminum, coated"

DN	A <sup>1)</sup>	B <sup>1)</sup>	C	D	F <sup>2) 3)</sup>	F <sup>2) 3)</sup>	G	K	L	M
[in]	[in]	[in]	[in]	[in]	[in]	[in]	[in]	[in]	[in]	[in]
3/8	5.83	3.70	2.13	2.95	7.28	10.24	5.35	0.21	<sup>4)</sup>	2.76
1/2	5.83	3.70	2.13	2.95	7.28	10.24	5.35	0.33	<sup>4)</sup>	2.76
1	5.83	3.70	2.13	2.95	7.28	10.24	5.35	0.47	<sup>4)</sup>	2.76
1 1/2	5.83	3.70	2.13	4.13	7.46	11.59	5.35	0.69	<sup>4)</sup>	3.11
2	5.83	3.70	2.13	5.55	7.85	13.41	5.35	1.02	<sup>4)</sup>	3.90
3	5.83	3.70	2.13	7.87	8.64	16.52	5.35	1.59	<sup>4)</sup>	5.47
4	5.83	3.70	2.13	10	9.37	19.37	5.35	2.02	<sup>4)</sup>	6.93
6	5.83	3.70	2.13	14.88	10.2	25.08	5.35	2.71	<sup>4)</sup>	8.58
10	5.83	3.70	2.13	21.57	11.91	33.48	5.35	4.03	<sup>4)</sup>	12.01

1) Depending on the cable gland used: values up to + 1.18 in

2) With order code for "Sensor option", option CG or order code for "Measuring tube material", option SD, SE, SF, TH: values + 2.76 in

3) If using a display, order code for "Display; Operation", option B: values + 1.1 in

4) Depends on the particular process connection →  80

Order code for "Housing", option B "Compact, hygienic, stainless"

DN	A <sup>1)</sup>	B	C	D	F <sup>2) 3)</sup>	F <sup>2) 3)</sup>	G	K	L	M
[in]	[in]	[in]	[in]	[in]	[in]	[in]	[in]	[in]	[in]	[in]
3/8	5.39	3.07	2.32	2.95	7.09	10.04	5.28	0.21	<sup>4)</sup>	2.76
1/2	5.39	3.07	2.32	2.95	7.09	10.04	5.28	0.33	<sup>4)</sup>	2.76
1	5.39	3.07	2.32	2.95	7.09	10.04	5.28	0.47	<sup>4)</sup>	2.76
1 1/2	5.39	3.07	2.32	4.13	7.26	11.4	5.28	0.69	<sup>4)</sup>	3.11
2	5.39	3.07	2.32	5.55	7.66	13.21	5.28	1.02	<sup>4)</sup>	3.90
3	5.39	3.07	2.32	7.87	8.44	16.32	5.28	1.59	<sup>4)</sup>	5.47
4	5.39	3.07	2.32	10	9.17	19.17	5.28	2.02	<sup>4)</sup>	6.93

DN	A <sup>1)</sup>	B	C	D	F <sup>2) 3)</sup>	F <sup>2) 3)</sup>	G	K	L	M
[in]	[in]	[in]	[in]	[in]	[in]	[in]	[in]	[in]	[in]	[in]
6	5.39	3.07	2.32	14.88	10	24.88	5.28	2.71	<sup>4)</sup>	8.58
10	5.39	3.07	2.32	21.57	11.71	33.29	5.28	4.03	<sup>4)</sup>	12.01

- 1) Depending on the cable gland used: values up to + 1.18 in
- 2) With order code for "Sensor option", option CG or order code for "Measuring tube material", option SD, SE, SF, TH: values + 2.76 in
- 3) If using a display, order code for "Display; Operation", option B: values + 1.1 in
- 4) Depends on the particular process connection → ☰ 80

Order code for "Housing", option C "Ultra-compact, hygienic, stainless"

DN	A <sup>1)</sup>	B	C	D	F <sup>2) 3)</sup>	F <sup>2) 3)</sup>	G	K	L	M
[in]	[in]	[in]	[in]	[in]	[in]	[in]	[in]	[in]	[in]	[in]
$\frac{3}{8}$	4.88	2.68	2.20	2.95	7.09	10.04	4.41	0.21	<sup>4)</sup>	2.76
$\frac{1}{2}$	4.88	2.68	2.20	2.95	7.09	10.04	4.41	0.33	<sup>4)</sup>	2.76
1	4.88	2.68	2.20	2.95	7.09	10.04	4.41	0.47	<sup>4)</sup>	2.76
1½	4.88	2.68	2.20	4.13	7.26	11.4	4.41	0.69	<sup>4)</sup>	3.11
2	4.88	2.68	2.20	5.55	7.66	13.21	4.41	1.02	<sup>4)</sup>	3.90
3	4.88	2.68	2.20	7.87	8.44	16.32	4.41	1.59	<sup>4)</sup>	5.47
4	4.88	2.68	2.20	10	9.17	19.17	4.41	2.02	<sup>4)</sup>	6.93
6	4.88	2.68	2.20	14.88	10	24.88	4.41	2.71	<sup>4)</sup>	8.58
10	4.88	2.68	2.20	21.57	11.71	33.29	4.41	4.03	<sup>4)</sup>	12.01

- 1) Depending on the cable gland used: values up to + 1.18 in
- 2) With order code for "Sensor option", option CG or order code for "Measuring tube material", option SD, SE, SF, TH: values + 2.76 in
- 3) If using a display, order code for "Display; Operation", option B: values + 1.1 in
- 4) Depends on the particular process connection → ☰ 80

## Flange connections

### Fixed flange ASME B16.5

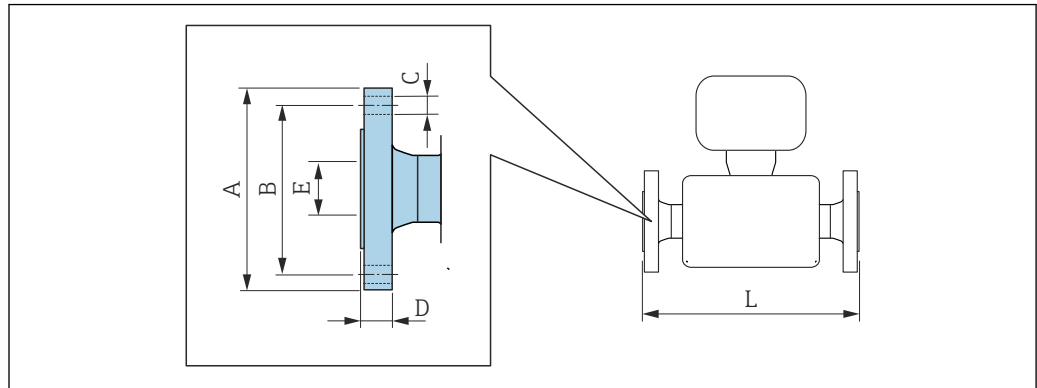

A0015621

**i** Length tolerance for dimension L in inches:

- DN ≤ 4": +0.06/-0.08
- DN ≥ 6": ±0.14

Flange similar to ASME B16.5: Class 150 1.4404 (F316/F316L): order code for "Process connection", option AAS Alloy C22: order code for "Process connection", option AAC						
DN [in]	A [in]	B [in]	C [in]	D [in]	E [in]	L [in]
$\frac{3}{8}$ <sup>1)</sup>	3.54	2.37	4 × Ø0.62	0.44	0.62	14.57
$\frac{1}{2}$	3.54	2.37	4 × Ø0.62	0.44	0.62	15.91
1	4.33	3.13	4 × Ø0.62	0.56	1.05	17.32
1½	4.92	3.87	4 × Ø0.63	0.63	1.61	21.65
2	5.91	4.75	4 × Ø0.75	0.75	2.07	28.15
3	7.48	6.00	4 × Ø0.75	0.94	3.07	33.07
4	9.06	7.50	8 × Ø0.75	0.94	4.03	44.37
6	11.02	9.50	8 × Ø0.88	1	6.07	55.04
10	15.94	14.25	12 × Ø1.0	1.19	10.02	72.13

Surface roughness (flange): Ra 126 to 248 µin

1) DN  $\frac{3}{8}$ " with DN  $\frac{1}{2}$ " flanges as standard

Flange similar to ASME B16.5: Class 150 with reduction in nominal diameter 1.4404 (F316/F316L)								
DN [in]	Reduction to DN [in]	Order code "Process connection", Option	A [in]	B [in]	C [in]	D [in]	E [in]	L [in]
2	1½	AHS	5.91	4.75	4 × Ø0.75	0.75	2.07	21.65
3	2	AJS	7.48	6	4 × Ø0.75	0.94	3.07	28.35
4	3	ALS	9.06	7.5	8 × Ø0.75	0.94	4.03	34.41
6	4	ANS	11.02	9.5	8 × Ø0.88	1	6.07	45.94
8	6	APS	13.58	11.75	8 × Ø0.88	1.14	7.98	57.52

Surface roughness (flange): Ra 126 to 248 µin



<b>Flange similar to ASME B16.5: Class 300</b>						
<b>1.4404 (F316/F316L): order code for "Process connection", option ABS</b>						
<b>Alloy C22: order code for "Process connection", option ABC</b>						
DN [in]	A [in]	B [in]	C [in]	D [in]	E [in]	L [in]
3/8 <sup>1)</sup>	3.74	2.63	4 × Ø0.62	0.56	0.62	14.57
1/2	3.74	2.63	4 × Ø0.62	0.56	0.62	15.91
1	4.92	3.50	4 × Ø0.75	0.69	1.05	17.32
1½	6.10	4.50	4 × Ø0.88	0.81	1.61	21.65
2	6.50	5.00	8 × Ø0.75	0.88	2.07	28.15
3	8.27	6.63	8 × Ø0.88	1.12	3.07	33.07
4	10.04	7.87	8 × Ø0.88	1.25	4.03	44.37
6	12.6	10.63	12 × Ø0.88	1.44	6.07	55.79
10	17.52	15.25	16 × Ø1.12	1.87	10.02	73.35
Surface roughness (flange): Ra 126 to 248 µin						

1) DN 3/8" with DN 1/2" flanges as standard

<b>Flange similar to ASME B16.5: Class 300 with reduction in nominal diameter</b>								
<b>1.4404 (F316/F316L)</b>								
DN [in]	Reduction to DN [in]	Order code "Process connection", Option	A [in]	B [in]	C [in]	D [in]	E [in]	L [in]
2	1½	AIS	6.5	5	8 × Ø0.75	0.88	2.07	24.21
3	2	AKS	8.27	6.63	8 × Ø0.88	1.12	3.07	28.82
4	3	AMS	10.04	7.87	8 × Ø0.88	1.25	4.03	35.2
6	4	AOS	12.6	10.63	12 × Ø0.88	1.44	6.07	46.73
8	6	AQS	14.96	13	12 × Ø1	1.64	7.98	57.52
Surface roughness (flange): Ra 126 to 248 µin								

<b>Flange similar to ASME B16.5: Class 600</b>						
<b>1.4404 (F316/F316L): order code for "Process connection", option ACS</b>						
<b>Alloy C22: order code for "Process connection", option ACC</b>						
DN [in]	A [in]	B [in]	C [in]	D [in]	E [in]	L [in]
3/8 <sup>1)</sup>	3.74	2.63	4 × Ø0.62	0.81	0.55	15.75
1/2	3.74	2.63	4 × Ø0.62	0.81	0.55	16.54
1	4.92	3.50	4 × Ø0.75	0.94	0.96	19.29
1½	6.10	4.50	4 × Ø0.88	1.13	1.5	23.62
2	6.50	5.00	8 × Ø0.75	1.25	1.94	29.21
3	8.27	6.63	8 × Ø0.88	1.5	2.9	35.43
4	10.83	8.50	8 × Ø1.00	1.91	3.83	45.55
6	13.98	11.50	12 × Ø1.12	1.88	6.07	57.76
10	20.08	17.00	16 × Ø1.38	2.75	10.02	76.61
Surface roughness (flange): Ra 126 to 248 µin						

1) DN 3/8" with DN 1/2" flanges as standard

## Lap joint flange ASME B16.5

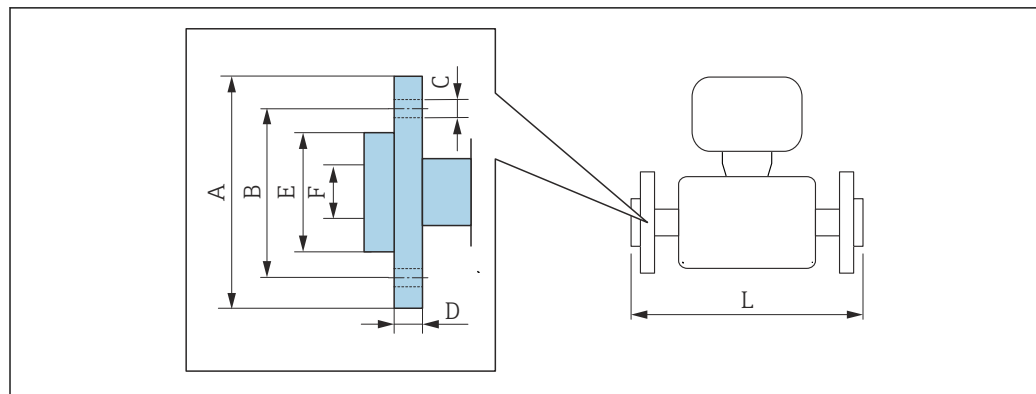

A002221

**i** Length tolerance for dimension L in inch:  
+0.06 / -0.08

Lap joint flange similar to ASME B16.5: Class 150								
1.4301 (F304), wetted parts Alloy C22								
Order code for "Process connection", option ADC								
DN [in]	A [in]	B [in]	C [in]	D [in]	E [in]	F [in]	L [in]	L <sub>diff</sub> <sup>1)</sup> [in]
$\frac{3}{8}$ <sup>2)</sup>	3.54	2.37	4 × Ø 0.62	0.59	1.38	0.62	14.57	0
$\frac{1}{2}$	3.54	2.37	4 × Ø 0.62	0.59	1.38	0.62	15.91	0
1	4.33	3.13	4 × Ø 0.62	0.63	2	1.05	17.32	0
1½	4.92	3.87	4 × Ø 0.62	0.63	2.88	1.61	21.65	0
2	5.91	4.75	4 × Ø 0.75	0.75	3.62	2.07	28.15	0
3	7.48	6.00	4 × Ø 0.75	0.88	5	3.07	33.07	0
4	9.06	7.50	8 × Ø 0.75	1.02	6.19	4.03	44.37	0

Surface roughness (flange): Ra 126 to 492 µin

- 1) Difference to installed length of the welding neck flange (order code for "Process connection", option AAC)  
2) DN  $\frac{3}{8}$ " with DN  $\frac{1}{2}$ " flanges as standard

Lap joint flange similar to ASME B16.5: Class 300								
1.4301 (F304), wetted parts Alloy C22								
Order code for "Process connection", option AEC								
DN [in]	A [in]	B [in]	C [in]	D [in]	E [in]	F [in]	L [in]	L <sub>diff</sub> <sup>1)</sup> [in]
$\frac{3}{8}$ <sup>2)</sup>	3.74	2.63	4 × Ø 0.62	0.65	1.38	0.62	14.8	+0.23
$\frac{1}{2}$	3.74	2.63	4 × Ø 0.62	0.65	1.38	0.62	15.98	+0.07
1	4.92	3.50	4 × Ø 0.75	0.83	2	1.05	17.72	+0.40
1½	6.10	4.50	4 × Ø 0.88	0.91	2.88	1.61	22.2	+0.55
2	6.50	5.00	8 × Ø 0.75	1	3.62	2.07	28.23	+0.08
3	8.27	6.63	8 × Ø 0.88	1.22	5	3.07	33.57	+0.50
4	10.04	7.87	8 × Ø 0.88	1.26	6.19	4.03	44.84	+0.47

Surface roughness (flange): Ra 126 to 492 µin

- 1) Difference to installed length of the welding neck flange (order code for "Process connection", option AAC)  
2) DN  $\frac{3}{8}$ " with DN  $\frac{1}{2}$ " flanges as standard

<b>Lap joint flange similar to ASME B16.5, Class 600</b> <b>1.4301 (F304), wetted parts Alloy C22</b> Order code for "Process connection", option AFC								
DN [in]	A [in]	B [in]	C [in]	D [in]	E [in]	F [in]	L [in]	L <sub>diff</sub> <sup>1)</sup> [in]
<sup>3</sup> / <sub>8</sub> <sup>2)</sup>	3.74	2.63	4 × Ø 0.62	0.67	1.38	0.55	15.75	0
<sup>1</sup> / <sub>2</sub>	3.74	2.63	4 × Ø 0.62	0.67	1.38	0.55	16.54	0
1	4.92	3.50	4 × Ø 0.75	0.85	2	0.96	19.29	0
1½	6.10	4.50	4 × Ø 0.88	0.98	2.88	1.5	23.62	0
2	6.50	5.00	8 × Ø 0.75	1.1	3.62	1.94	29.21	0
3	8.27	6.63	8 × Ø 0.88	1.38	5	2.9	35.43	0
4	10.83	8.50	8 × Ø 1	1.73	6.19	3.83	45.94	+0.39
Surface roughness (flange): Ra 126 to 492 µin								

- 1) Difference to installed length of the welding neck flange (order code for "Process connection", option AAC)
- 2) DN <sup>3</sup>/<sub>8</sub>" with DN <sup>1</sup>/<sub>2</sub>" flanges as standard

## Clamp connections

### Tri-Clamp

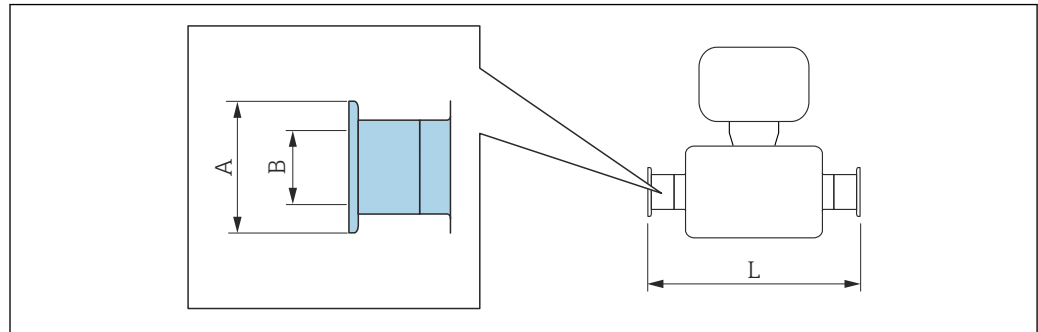

A0015625

**i** Length tolerance for dimension L in inch:  
+0.06 / -0.08

Tri-Clamp (½"), DIN 11866 series C 1.4404 (316/316L) Order code for "Process connection", option FDW				
DN [in]	Clamp [in]	A [in]	B [in]	L [in]
¾	½	0.98	0.37	14.4
½	½	0.98	0.37	15.7

3-A version available: order code for "Additional approval", option LP in conjunction with  
 Ra ≤ 30 µin: order code for "Measuring tube material", option SB, SE, SJ, SJ, SL or  
 Ra ≤ 15 µin: order code for "Measuring tube material", option SC, SF, SK, SM  
 Ra ≤ 15 µin electropolished: order code for "Measuring tube material", option BC, BG

Tri-Clamp (≥ 1"), DIN 11866 series C 1.4404 (316/316L) Order code for "Process connection", option FTS				
DN [in]	Clamp [in]	A [in]	B [in]	L [in]
¾	1	1.98	0.87	14.4
½	1	1.98	0.87	15.7
1	1	1.98	0.87	17.1
1½	1½	1.98	1.37	22.0
2	2	2.52	1.87	28.3
3	3	3.58	2.87	35.4
4	4	4.68	3.83	44.4

3-A version available: order code for "Additional approval", option LP in conjunction with  
 Ra ≤ 30 µin: order code for "Measuring tube material", option SB, SE, SJ, SJ, SL or  
 Ra ≤ 15 µin: order code for "Measuring tube material", option SC, SF, SK, SM  
 Ra ≤ 15 µin electropolished: order code for "Measuring tube material", option BC, BG

**Threaded couplings**

*Threaded adapter SMS 1145*

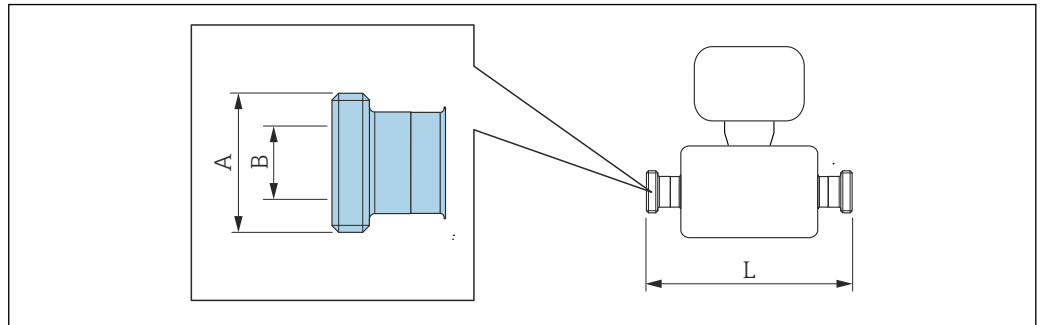

A0015628

**i** Length tolerance for dimension L in inch:  
+0.06 / -0.08

<b>Threaded adapter SMS 1145</b> <b>1.4404 (316/316L)</b> <i>Order code for "Process connection", option SCS</i>			
DN [in]	A [in]	B [in]	L [in]
3/8	Rd 40 × 1/6	0.89	14.45
1/2	Rd 40 × 1/6	0.89	15.67
1	Rd 40 × 1/6	0.89	17.09
1 1/2	Rd 60 × 1/6	1.4	22.05
2	Rd 70 × 1/6	1.91	28.35
3	Rd 98 × 1/6	2.87	35.43
4	Rd 132 × 1/6	3.84	44.37

3-A version available: order code for "Additional approval", option LP in conjunction with  
 Ra ≤ 30 µin: order code for "Measuring tube material", option SB, SE, SJ, SL

VCO

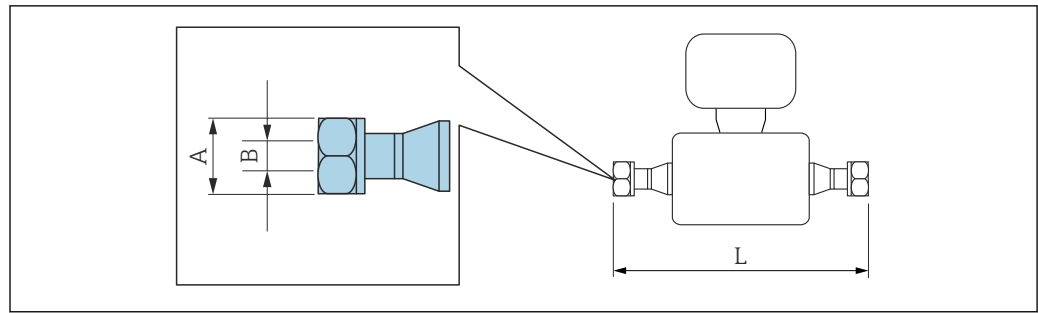

A0015624

**i** Length tolerance for dimension L in inch:  
+0.06 / -0.08

**8-VCO-4 (1/2")**

**1.4404 (316/316L)**

Order code for "Process connection", option CVS

DN [in]	A [in]	B [in]	L [in]
3/8	AF 1	0.4	15.35

**12-VCO-4 (3/4")**

**1.4404 (316/316L)**

Order code for "Process connection", option CWS

DN [in]	A [in]	B [in]	L [in]
1/2	AF 1 1/2	0.62	16.93

**Safety Barrier Promass 100**

Top-hat rail EN 60715:

- TH 35 x 7.5
- TH 35 x 15

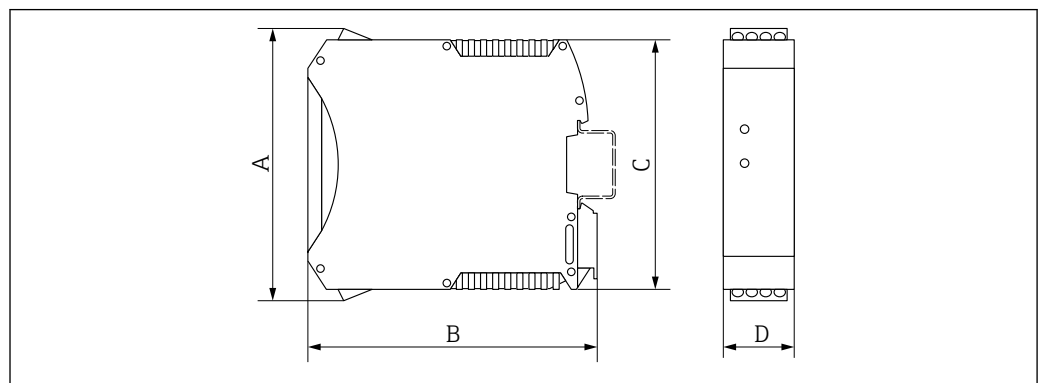

A0016777

A [in]	B [in]	C [in]	D [in]
4.25	4.51	3.9	0.89

**Accessories**

*Rupture disk/purge connections*

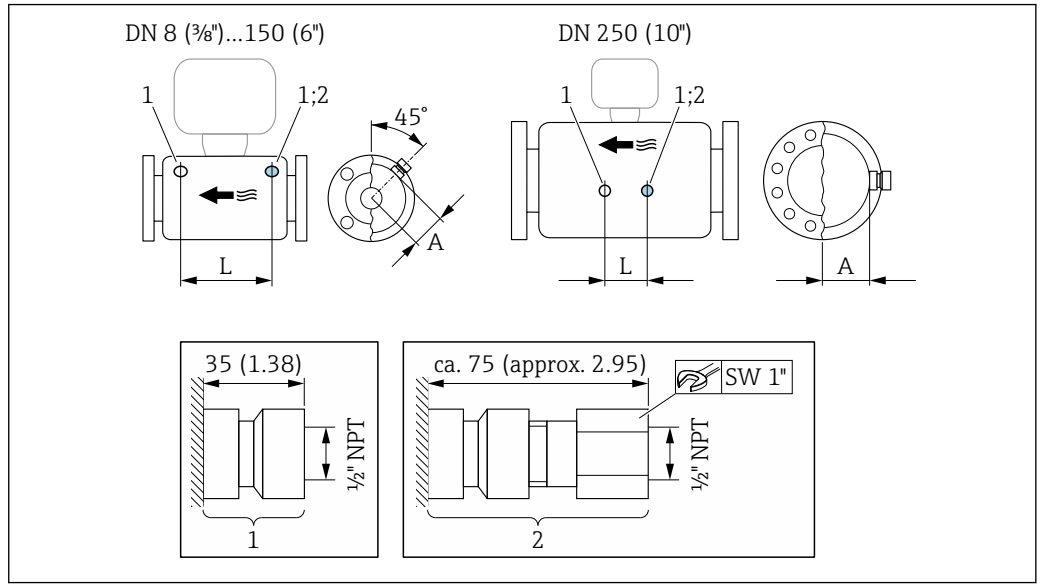

A0028914

- 1 Connection nipple for purge connections: order code for "Sensor options", option CH "Purge connection"
- 2 Connection nipple with rupture disk: order code for "Sensor option", option CA "Rupture disk"

DN	A	L
[in]	[in]	[in]
3/8	2.44	8.50
1/2	2.44	8.66
1	2.44	10.24
1 1/2	2.64	12.20
2	3.11	17.78
3	3.98	22.0
4	4.72	27.0
6	5.55	34.6
10	7.17	14.96

**Weight**

All values (weight exclusive of packaging material) refer to devices with EN/DIN PN 40 flanges. Weight specifications including transmitter: order code for "Housing", option A "Compact, aluminum coated".

**Weight in SI units**

DN [mm]	Weight [kg]
8	9
15	10
25	12
40	17
50	28
80	53
100	94

DN [mm]	Weight [kg]
150	152
250	398

#### Weight in US units

DN [in]	Weight [lbs]
3/8	20
1/2	22
1	26
1 1/2	37
2	62
3	117
4	207
6	335
10	878

#### Safety Barrier Promass 100

49 g (1.73 ounce)

#### Materials

##### Transmitter housing

- Order code for "Housing", option **A** "Compact, aluminum coated":  
Aluminum, AlSi10Mg, coated
- Order code for "Housing", option **B** "Compact, hygienic, stainless":
  - Hygienic version, stainless steel 1.4301 (304)
  - Optional: order code for "Sensor feature", option CC  
Hygienic version, for maximum corrosion resistance: stainless steel 1.4404 (316L)
- Order code for "Housing", option **C** "Ultra-compact, hygienic, stainless":
  - Hygienic version, stainless steel 1.4301 (304)
  - Optional: order code for "Sensor feature", option CC  
Hygienic version, for maximum corrosion resistance: stainless steel 1.4404 (316L)
- Window material for optional local display (→ 91):
  - For order code for "Housing", option **A**: glass
  - For order code for "Housing", option **B** and **C**: plastic

##### Cable entries/cable glands

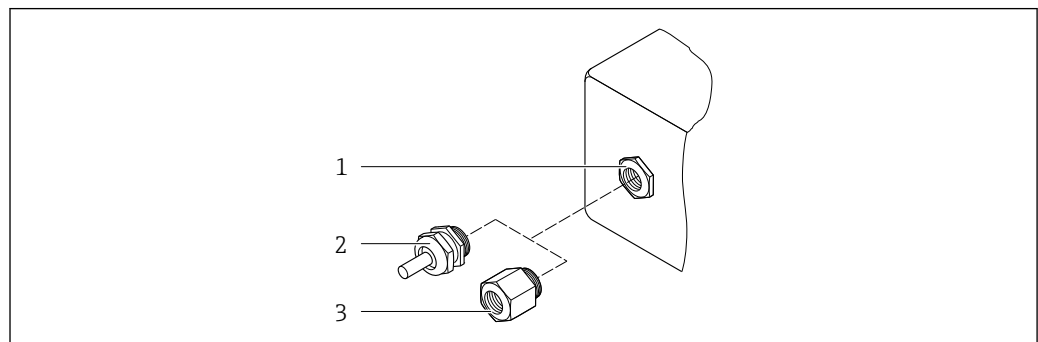

39 Possible cable entries/cable glands

- 1 Female thread M20 × 1.5
- 2 Cable gland M20 × 1.5
- 3 Adapter for cable entry with female thread G 1/2" or NPT 1/2"



Order code for "Housing", option A "Compact, aluminum, coated"

The various cable entries are suitable for hazardous and non-hazardous areas.

Cable entry/cable gland	Material
Cable gland M20 × 1.5	Nickel-plated brass
Adapter for cable entry with internal thread G ½"	
Adapter for cable entry with internal thread NPT ½"	

Order code for "Housing", option B "Compact, hygienic, stainless"

The various cable entries are suitable for hazardous and non-hazardous areas.

Cable entry/cable gland	Material
Cable gland M20 × 1.5	Stainless steel, 1.4404 (316L)
Adapter for cable entry with internal thread G ½"	
Adapter for cable entry with internal thread NPT ½"	

**Device plug**

Electrical connection	Material
Plug M12x1	<ul style="list-style-type: none"> <li>▪ Socket: Stainless steel, 1.4404 (316L)</li> <li>▪ Contact housing: Polyamide</li> <li>▪ Contacts: Gold-plated brass</li> </ul>

**Sensor housing**

 The material of the sensor housing depends on the option selected in the order code for "Measuring tube mat., wetted surface".

Order code for "Measuring tube mat., wetted surface"	Material
Option HA, SA, SD, TH	<ul style="list-style-type: none"> <li>▪ Acid and alkali-resistant outer surface</li> <li>▪ Stainless steel 1.4301 (304)</li> </ul> <p> With order code for "Sensor option", option CC "316L Sensor housing": stainless steel, 1.4404 (316L)</p>
Option SB, SC, SE, SF	<ul style="list-style-type: none"> <li>▪ Acid and alkali-resistant outer surface</li> <li>▪ Stainless steel 1.4301 (304)</li> </ul>

**Measuring tubes**

- DN 8 to 100 (3/8 to 4"): stainless steel, 1.4539 (904L);  
Manifold: stainless steel, 1.4404 (316/316L)
- DN 150 (6"), DN 250 (10"): stainless steel, 1.4404 (316/316L);  
Manifold: stainless steel, 1.4404 (316/316L)
- DN 8 to 250 (3/8 to 10"): Alloy C22, 2.4602 (UNS N06022);  
Manifold: Alloy C22, 2.4602 (UNS N06022)

**Process connections**

- Flanges according to EN 1092-1 (DIN2501) / according to ASME B 16.5 / as per JIS B2220:
  - Stainless steel, 1.4404 (F316/F316L)
  - Alloy C22, 2.4602 (UNS N06022)
  - Lap joint flanges: stainless steel, 1.4301 (F304); wetted parts Alloy C22
- All other process connections:  
Stainless steel, 1.4404 (316/316L)



Available process connections → 90

**Seals**

Welded process connections without internal seals

**Safety Barrier Promass 100**

Housing: Polyamide

**Process connections**

- Fixed flange connections:
  - EN 1092-1 (DIN 2501) flange
  - EN 1092-1 (DIN 2512N) flange
  - NAMUR lengths in accordance with NE 132
  - ASME B16.5 flange
  - JIS B2220 flange
  - DIN 11864-2 Form A flange, DIN 11866 series A, flange with notch
- Clamp connections:  
Tri-Clamp (OD tubes), DIN 11866 series C
- Thread:
  - DIN 11851 thread, DIN 11866 series A
  - SMS 1145 thread
  - ISO 2853 thread, ISO 2037
  - DIN 11864-1 Form A thread, DIN 11866 series A
- VCO connections:
  - 8-VCO-4
  - 12-VCO-4



Process connection materials

**Surface roughness**

All data refer to parts in contact with the medium.

*The following surface roughness categories can be ordered:*

Category	Method	Option(s) order code "Measuring tube mat., wetted surface"
Not polished	–	HA, LA, SA, SD, TH, TS, TT, TU
$Ra \leq 0.76 \mu\text{m}$ (30 $\mu\text{in}$ ) <sup>1)</sup>	Mechanically polished <sup>2)</sup>	SB, SE
$Ra \leq 0.76 \mu\text{m}$ (30 $\mu\text{in}$ ) <sup>1)</sup>	Mechanically polished <sup>2)</sup> , welds in as-welded condition	SJ, SL
$Ra \leq 0.38 \mu\text{m}$ (15 $\mu\text{in}$ ) <sup>1)</sup>	Mechanically polished <sup>2)</sup>	SC, SF
$Ra \leq 0.38 \mu\text{m}$ (15 $\mu\text{in}$ ) <sup>1)</sup>	Mechanically polished <sup>2)</sup> , welds in as-welded condition	SK, SM
$Ra \leq 0.38 \mu\text{m}$ (15 $\mu\text{in}$ ) <sup>1)</sup>	Mechanical <sup>2)</sup> and electropolished	BC
$Ra \leq 0.38 \mu\text{m}$ (15 $\mu\text{in}$ ) <sup>1)</sup>	Mechanical <sup>2)</sup> and electropolished, welds in as-welded condition	BG

1) Ra according to ISO 21920

2) Except for inaccessible welds between pipe and manifold

## Operability

### Operating concept

#### Operator-oriented menu structure for user-specific tasks

- Commissioning
- Operation
- Diagnostics
- Expert level

#### Quick and safe commissioning

- Individual menus for applications
- Menu guidance with brief explanations of the individual parameter functions

#### Reliable operation

- Operation in the following languages:
  - Via "FieldCare", "DeviceCare" operating tool: English, German, French, Spanish, Italian, Chinese, Japanese
  - Via integrated Web browser (only available for device versions with HART, PROFIBUS DP, PROFINET and EtherNet/IP): English, German, French, Spanish, Italian, Dutch, Portuguese, Polish, Russian, Turkish, Chinese, Japanese, Bahasa (Indonesian), Vietnamese, Czech, Swedish, Korean
- Uniform operating philosophy applied to operating tools and Web browser
- If replacing the electronic module, transfer the device configuration via the plug-in memory (HistoROM DAT) which contains the process and measuring device data and the event logbook. No need to reconfigure.  
For devices with Modbus RS485, the data recovery function is implemented without the plug-in memory (HistoROM DAT).

#### Efficient diagnostics increase measurement availability

- Troubleshooting measures can be called up via the operating tools and web browser
- Diverse simulation options
- Status indicated by several light emitting diodes (LEDs) on the electronic module in the housing compartment

### Local display



A local display is only available for device versions with the following communication protocols: HART, PROFIBUS-DP, PROFINET, EtherNet/IP

The local display is only available with the following device order code:  
Order code for "Display; operation", option **B**: 4-line; illuminated, via communication

#### Display element

- 4-line liquid crystal display with 16 characters per line.
- White background lighting; switches to red in event of device errors.
- Format for displaying measured variables and status variables can be individually configured.
- Permitted ambient temperature for the display: -20 to +60 °C (-4 to +140 °F). The readability of the display may be impaired at temperatures outside the temperature range.

### Remote operation

#### Via HART protocol

This communication interface is available in device versions with a HART output.

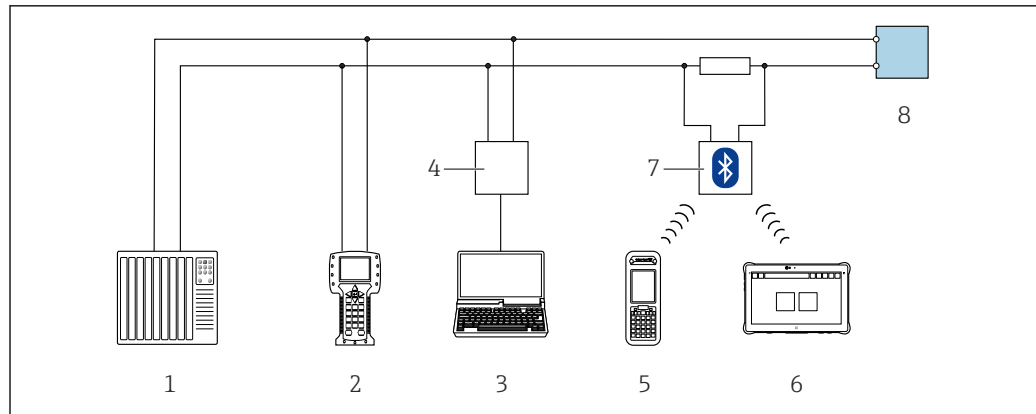

A0028747

40 Options for remote operation via HART protocol

- 1 Control system (e.g. PLC)
- 2 Field Communicator 475
- 3 Computer with operating tool (e.g. FieldCare, AMS Device Manager, SIMATIC PDM)
- 4 Commubox FXA 195 (USB)
- 5 Field Xpert SFX350 or SFX370
- 6 Field Xpert SMT70
- 7 VIATOR Bluetooth modem with connecting cable
- 8 Transmitter

#### Via PROFIBUS DP network

This communication interface is available in device versions with PROFIBUS DP.

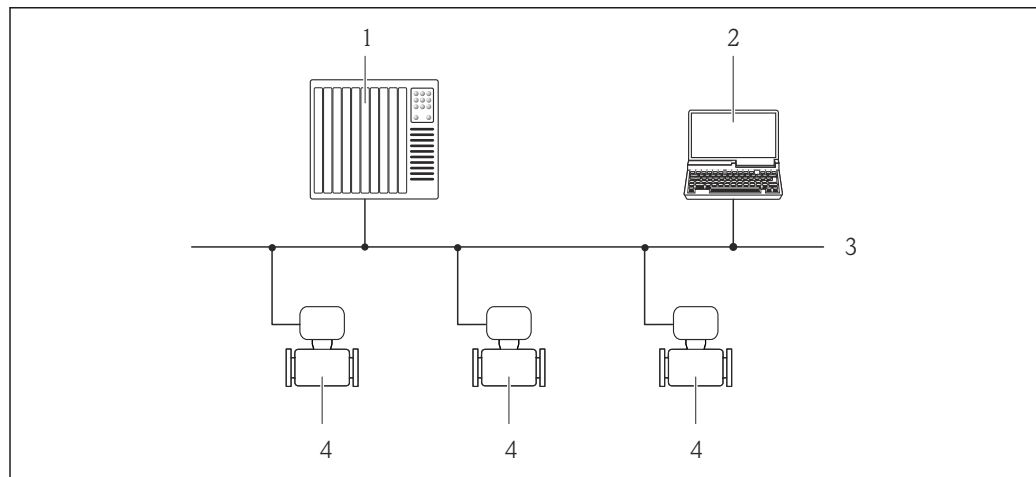

A0020903

41 Options for remote operation via PROFIBUS DP network

- 1 Automation system
- 2 Computer with PROFIBUS network card
- 3 PROFIBUS DP network
- 4 Measuring device

#### Via EtherNet/IP network

This communication interface is available in device versions with EtherNet/IP.

Star topology

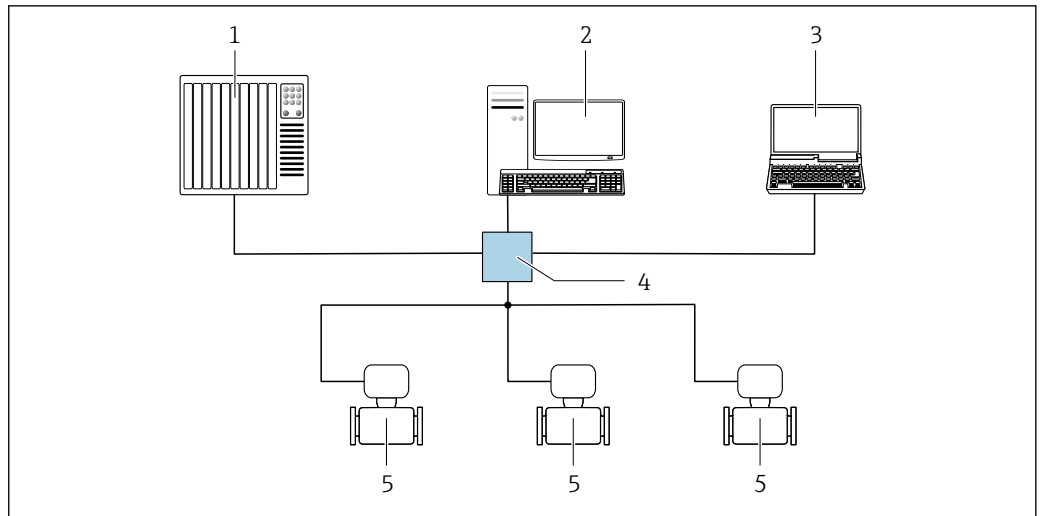

A0032078

42 Options for remote operation via EtherNet/IP network: star topology

- 1 Automation system, e.g. "RSLogix" (Rockwell Automation)
- 2 Workstation for measuring device operation: with Custom Add-On Profile for "RSLogix 5000" (Rockwell Automation) or with Electronic Data Sheet (EDS)
- 3 Computer with Web browser (e.g. Internet Explorer) for accessing the integrated Web server or computer with operating tool (e.g. FieldCare, DeviceCare) with COM DTM "CDI Communication TCP/IP"
- 4 Standard Ethernet switch, e.g. Scalance X204 (Siemens)
- 5 Measuring device

Via PROFINET network

This communication interface is available in device versions with PROFINET.

Star topology

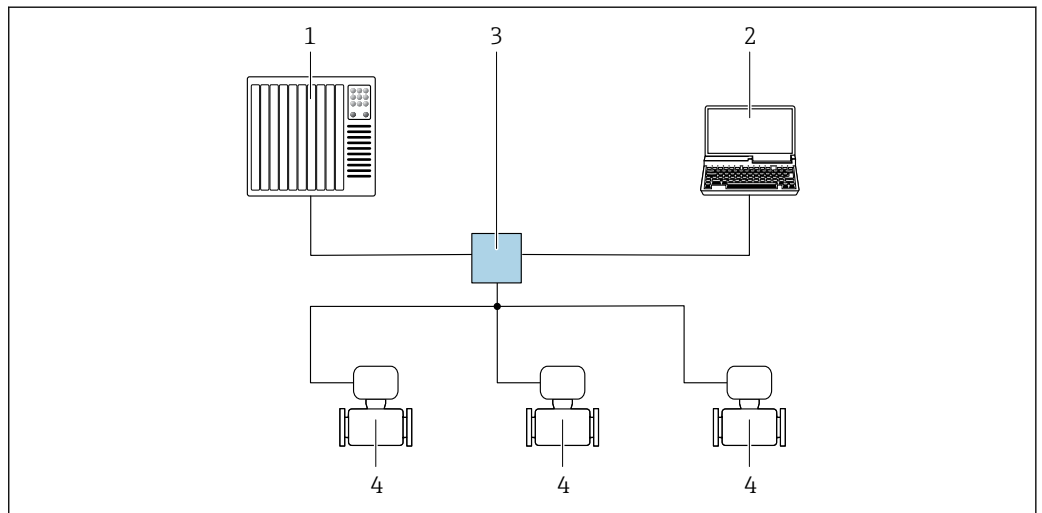

A0026545

43 Options for remote operation via PROFINET network: star topology

- 1 Automation system, e.g. Simatic S7 (Siemens)
- 2 Computer with Web browser (e.g. Internet Explorer) for accessing the integrated Web server or computer with operating tool (e.g. FieldCare, DeviceCare, SIMATIC PDM) with COM DTM "CDI Communication TCP/IP"
- 3 Standard Ethernet switch, e.g. Scalance X204 (Siemens)
- 4 Measuring device

## Service interface

## Via service interface (CDI-RJ45)

This communication interface is present in the following device version:

- Order code for "Output", option **B**: 4-20 mA HART, pulse/frequency/switch output
- Order code for "Output", option **L**: PROFIBUS DP
- Order code for "Output", option **N**: EtherNet/IP
- Order code for "Output", option **R**: PROFINET

## HART

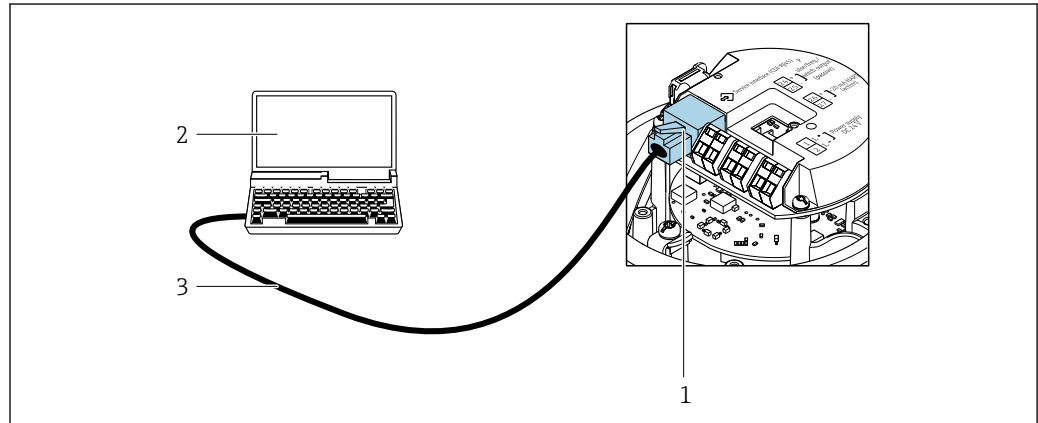

44 Connection for the order code for "Output", option B: 4-20 mA HART, pulse/frequency/switch output

- 1 Service interface (CDI-RJ45) of the measuring device with access to the integrated web server
- 2 Computer with web browser (e.g. Internet Explorer) for accessing the integrated web server or with "FieldCare" operating tool with COM DTM "CDI Communication TCP/IP"
- 3 Standard Ethernet connecting cable with RJ45 plug

## PROFIBUS DP

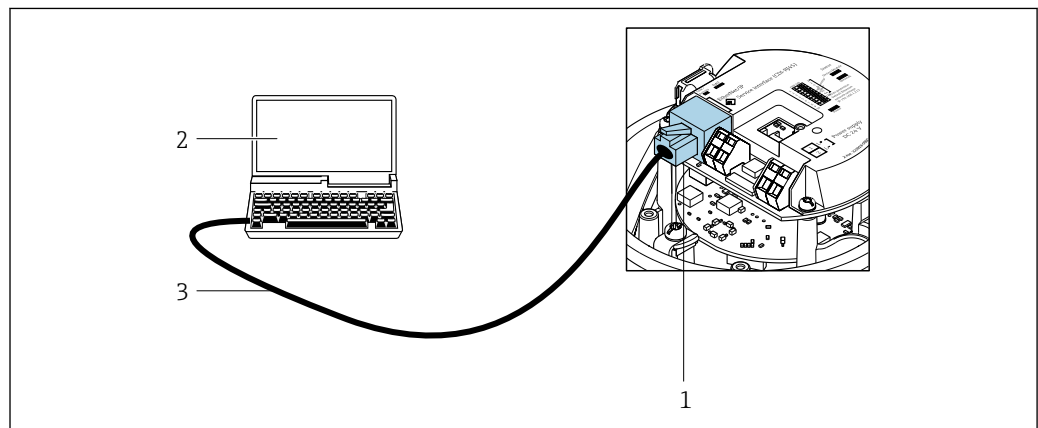

45 Connection for order code for "Output", option L: PROFIBUS DP

- 1 Service interface (CDI-RJ45) of the measuring device with access to the integrated web server
- 2 Computer with web browser (e.g. Internet Explorer) for accessing the integrated web server or with "FieldCare" operating tool with COM DTM "CDI Communication TCP/IP"
- 3 Standard Ethernet connecting cable with RJ45 plug

*EtherNet/IP*

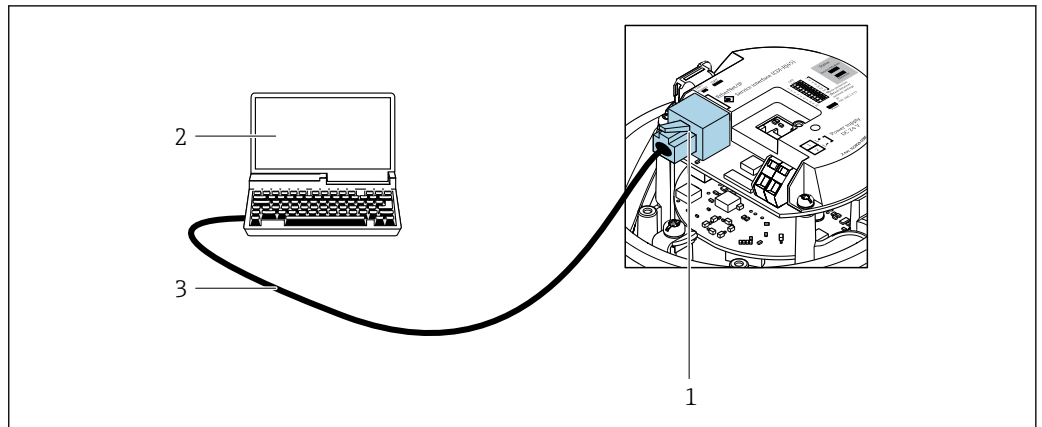

A0016940

46 Connection for order code for "Output", option N: EtherNet/IP

- 1 Service interface (CDI-RJ45) and EtherNet/IP interface of the measuring device with access to the integrated web server
- 2 Computer with web browser (e.g. Internet Explorer) for accessing the integrated web server or with "FieldCare" operating tool with COM DTM "CDI Communication TCP/IP"
- 3 Standard Ethernet connecting cable with RJ45 plug

*PROFINET*

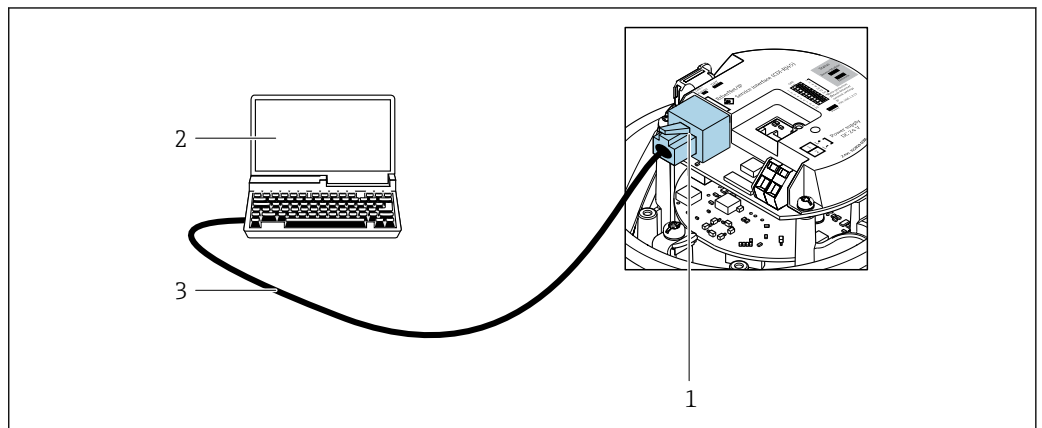

A0016940

47 Connection for order code for "Output", option R: PROFINET

- 1 Service interface (CDI-RJ45) and PROFINET interface of the measuring device with access to the integrated web server
- 2 Computer with web browser (e.g. Internet Explorer) for accessing the integrated web server or with "FieldCare" operating tool with COM DTM "CDI Communication TCP/IP"
- 3 Standard Ethernet connecting cable with RJ45 plug

**Via service interface (CDI)**

This communication interface is present in the following device version:  
 Order code for "Output", option **M**: Modbus RS485

## Modbus RS485

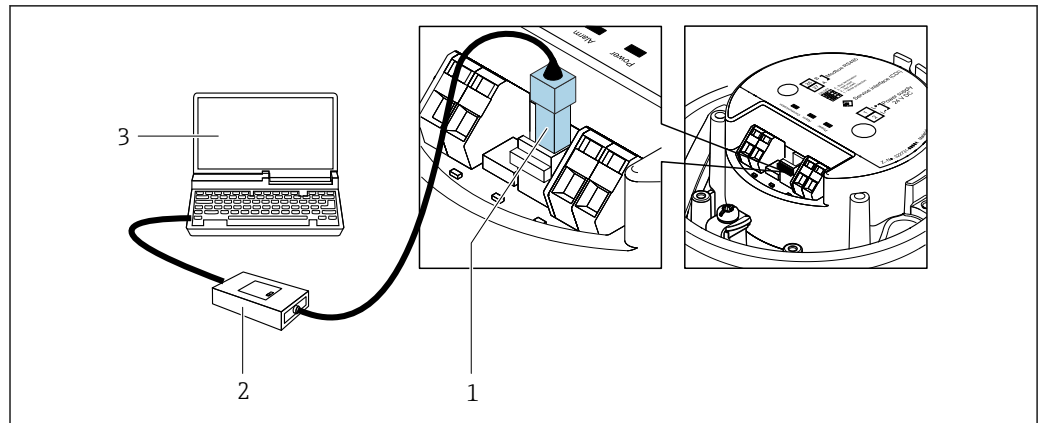

A0030216

- 1 Service interface (CDI) of measuring device
- 2 Commubox FXA291
- 3 Computer with "FieldCare" operating tool with COM DTM "CDI Communication FXA291"

## Certificates and approvals

Current certificates and approvals for the product are available at [www.endress.com](http://www.endress.com) on the relevant product page:

1. Select the product using the filters and search field.
2. Open the product page.
3. Select **Downloads**.

### CE mark

The device meets the legal requirements of the applicable EU Directives. These are listed in the corresponding EU Declaration of Conformity along with the standards applied.

Endress+Hauser confirms successful testing of the device by affixing to it the CE mark.

### UKCA marking

The device meets the legal requirements of the applicable UK regulations (Statutory Instruments). These are listed in the UKCA Declaration of Conformity along with the designated standards. By selecting the order option for UKCA marking, Endress+Hauser confirms a successful evaluation and testing of the device by affixing the UKCA mark.

Contact address Endress+Hauser UK:

Endress+Hauser Ltd.  
Floats Road  
Manchester M23 9NF  
United Kingdom  
[www.uk.endress.com](http://www.uk.endress.com)

### RCM marking

The measuring system meets the EMC requirements of the "Australian Communications and Media Authority (ACMA)".

### Ex approval

The measuring device is certified for use in hazardous areas and the relevant safety instructions are provided in the separate "Safety Instructions" (XA) document. Reference is made to this document on the nameplate.

- i** The separate Ex documentation (XA) containing all the relevant explosion protection data is available from your Endress+Hauser sales center.

### ATEX/IECEx

Currently, the following versions for use in hazardous areas are available:



*Ex ia*

Category (ATEX)	Type of protection
II1/2G	Ex ia IIC T6...T1 Ga/Gb or Ex ia IIB T6...T1 Ga/Gb
II2G	Ex ia IIC T6...T1 Gb or Ex ia IIB T6...T1 Gb
II1/2G, II2D	Ex ia IIC T6...T1 Ga/Gb or Ex ia IIB T6...T1 Ga/Gb Ex tb IIIC Txx °C Db
II2G, II2D	Ex ia IIC T6...T1 Gb or Ex ia IIB T6...T1 Gb Ex tb IIIC Txx °C Db

*Ex nA*

Category (ATEX)	Type of protection
II3G	Ex nA IIC T6...T1 Gc or Ex nA IIC T5-T1 Gc

**cCSA<sub>US</sub>**

Currently, the following versions for use in hazardous areas are available:

*IS (Ex i)*

- Class I Division 1 Groups ABCD
- Class II Division 1 Groups EFG and Class III

*NI (Ex nA)*

Class I Division 2 Groups ABCD

**Hygienic compatibility**

- 3-A approval
  - Only measuring instruments with the order code for "Additional approval", option LP "3A" have 3-A approval.
  - The 3-A approval refers to the measuring instrument.
  - When installing the measuring instrument, ensure that no liquid can accumulate on the outside of the measuring instrument.  
A remote display module must be installed in accordance with the 3-A Standard.
  - Accessories (e.g. heating jacket, weather protection cover, wall holder unit) must be installed in accordance with the 3-A Standard.  
Each accessory can be cleaned. Disassembly may be necessary under certain circumstances.
- EHEDG-tested  
Only devices with the order code for "Additional approval", option LT "EHEDG" have been tested and meet the requirements of the EHEDG.  
To meet the requirements for EHEDG certification, the device must be used with process connections in accordance with the EHEDG position paper entitled "Easy cleanable Pipe couplings and Process connections" ([www.ehedg.org](http://www.ehedg.org)).  
To meet the requirements for EHEDG certification, the device must be installed in a position that ensures drainability.

 Observe the special installation instructions →  47

**Pharmaceutical compatibility**

- FDA 21 CFR 177
- USP <87>
- USP <88> Class VI 121 °C
- TSE/BSE Certificate of Suitability

**HART certification**

**HART interface**

The measuring device is certified and registered by the FieldComm Group. The measuring system meets all the requirements of the following specifications:

- Certified according to HART 7
- The device can also be operated with certified devices of other manufacturers (interoperability)

<b>Certification PROFIBUS</b>	<b>PROFIBUS interface</b>
	<p>The measuring device is certified and registered by the PNO (PROFIBUS Nutzerorganisation e.V./ PROFIBUS User Organization). The measuring system meets all the requirements of the following specifications:</p> <ul style="list-style-type: none"> <li>■ Certified according to PA Profile 3.02</li> <li>■ The device can also be operated with certified devices of other manufacturers (interoperability)</li> </ul>
<b>Certification PROFINET</b>	<b>PROFINET interface</b>
	<p>The measuring device is certified and registered by the PNO (PROFIBUS Nutzerorganisation e.V. / PROFIBUS User Organization). The measuring system meets all the requirements of the following specifications:</p> <ul style="list-style-type: none"> <li>■ Certified according to: <ul style="list-style-type: none"> <li>■ Test specification for PROFINET devices</li> <li>■ PROFINET Security Level 1 – Netload Class 2 0 Mbps</li> </ul> </li> <li>■ The device can also be operated with certified devices of other manufacturers (interoperability)</li> <li>■ The device supports PROFINET S2 system redundancy.</li> </ul>
<b>EtherNet/IP certification</b>	<p>The measuring device is certified and registered by the ODVA (Open Device Vendor Association). The measuring system meets all the requirements of the following specifications:</p> <ul style="list-style-type: none"> <li>■ Certified in accordance with the ODVA Conformance Test</li> <li>■ EtherNet/IP Performance Test</li> <li>■ EtherNet/IP PlugFest compliance</li> <li>■ The device can also be operated with certified devices of other manufacturers (interoperability)</li> </ul>
<b>Modbus RS485 certification</b>	<p>The measuring device meets all the requirements of the MODBUS RS485 conformity test and has the "MODBUS RS485 Conformance Test Policy, Version 2.0". The measuring device has successfully passed all the test procedures carried out.</p>
<b>Pressure Equipment Directive</b>	<p>The measuring devices can be ordered with or without PED or PESR. If a device with PED or PESR is required, this must be ordered explicitly. For devices with nominal diameters less than or equal to DN 25 (1"), this is neither possible nor necessary. A UK order option must be selected for PESR under the order code for "Approvals".</p> <ul style="list-style-type: none"> <li>■ With the marking <ul style="list-style-type: none"> <li>a) PED/G1/x (x = category) or</li> <li>b) PESR/G1/x (x = category)</li> </ul> <p>on the sensor nameplate, Endress+Hauser confirms compliance with the "Essential Safety Requirements"</p> <ul style="list-style-type: none"> <li>a) specified in Annex I of the Pressure Equipment Directive 2014/68/EU or</li> <li>b) Schedule 2 of Statutory Instruments 2016 No. 1105.</li> </ul> </li> <li>■ Devices bearing this marking (PED or PESR) are suitable for the following types of medium: <ul style="list-style-type: none"> <li>■ Media in Group 1 and 2 with a vapor pressure greater than, or smaller and equal to 0.5 bar (7.3 psi)</li> <li>■ Unstable gases</li> </ul> </li> <li>■ Devices not bearing this marking (without PED or PESR) are designed and manufactured according to sound engineering practice. They meet the requirements of <ul style="list-style-type: none"> <li>a) Art. 4 Para. 3 of the Pressure Equipment Directive 2014/68/EU or</li> <li>b) Part 1, Para. 8 of Statutory Instruments 2016 No. 1105.</li> </ul> <p>The scope of application is indicated</p> <ul style="list-style-type: none"> <li>a) in diagrams 6 to 9 in Annex II of the Pressure Equipment Directive 2014/68/EU or</li> <li>b) Schedule 3, Para. 2 of Statutory Instruments 2016 No. 1105.</li> </ul> </li> </ul>
<b>External standards and guidelines</b>	<ul style="list-style-type: none"> <li>■ EN 60529 Degrees of protection provided by enclosures (IP code)</li> <li>■ IEC/EN 60068-2-6 Environmental influences: Test procedure - Test Fc: vibrate (sinusoidal).</li> <li>■ IEC/EN 60068-2-31 Environmental influences: Test procedure - Test Ec: shocks due to rough handling, primarily for devices.</li> <li>■ EN 61010-1 Safety requirements for electrical equipment for measurement, control and laboratory use - general requirements</li> </ul>

- EN 61326-1/-2-3  
EMC requirements for electrical equipment for measurement, control and laboratory use
- NAMUR NE 21  
Electromagnetic compatibility (EMC) of industrial process and laboratory control equipment
- NAMUR NE 32  
Data retention in the event of a power failure in field and control instruments with microprocessors
- NAMUR NE 43  
Standardization of the signal level for the breakdown information of digital transmitters with analog output signal.
- NAMUR NE 53  
Software of field devices and signal-processing devices with digital electronics
- NAMUR NE 80  
The application of the pressure equipment directive to process control devices
- NAMUR NE 105  
Specifications for integrating fieldbus devices in engineering tools for field devices
- NAMUR NE 107  
Self-monitoring and diagnosis of field devices
- NAMUR NE 131  
Requirements for field devices for standard applications
- NAMUR NE 132  
Coriolis mass meter
- NACE MR0103  
Materials resistant to sulfide stress cracking in corrosive petroleum refining environments.
- NACE MR0175/ISO 15156-1  
Materials for use in H<sub>2</sub>S-containing Environments in Oil and Gas Production.
- ETSI EN 300 328  
Guidelines for 2.4 GHz radio components.
- EN 301489  
Electromagnetic compatibility and radio spectrum matters (ERM).

## Ordering information

Detailed ordering information is available from your nearest sales organization [www.addresses.endress.com](http://www.addresses.endress.com) or in the Product Configurator at [www.endress.com](http://www.endress.com):

1. Select the product using the filters and search field.
2. Open the product page.
3. Select **Configuration**.



### Product Configurator - the tool for individual product configuration

- Up-to-the-minute configuration data
- Depending on the device: Direct input of measuring point-specific information such as measuring range or operating language
- Automatic verification of exclusion criteria
- Automatic creation of the order code and its breakdown in PDF or Excel output format
- Ability to order directly in the Endress+Hauser Online Shop

## Application packages

Many different application packages are available to enhance the functionality of the device. Such packages might be needed to address safety aspects or specific application requirements.

The application packages can be ordered with the device or subsequently from Endress+Hauser. Detailed information on the order code in question is available from your local Endress+Hauser sales center or on the product page of the Endress+Hauser website: [www.endress.com](http://www.endress.com).



Detailed information on the application packages:  
Special Documentation → 103

**Heartbeat Verification**

Meets the requirement for traceable verification to DIN ISO 9001:2008 Chapter 7.6 a) "Control of monitoring and measuring equipment".

- Functional testing in the installed state without interrupting the process.
- Traceable verification results on request, including a report.
- Simple testing process via local operation or other operating interfaces.
- Clear measuring point assessment (pass/fail) with high test coverage within the framework of manufacturer specifications.
- Extension of calibration intervals according to operator's risk assessment.

**Heartbeat Monitoring**

Continuously supplies data, which are characteristic of the measuring principle, to an external condition monitoring system for the purpose of preventive maintenance or process analysis. These data enable the operator to:

- Draw conclusions - using these data and other information - about the impact process influences (e.g. corrosion, abrasion, buildup etc.) have on the measuring performance over time.
- Schedule servicing in time.
- Monitor the process or product quality, e.g. gas pockets .



For detailed information, see the Special Documentation for the device.

**Concentration measurement**

Order code for "Application package", option ED "Concentration"

Calculation and outputting of fluid concentrations.

The measured density is converted to the concentration of a substance of a binary mixture using the "Concentration" application package:

- Choice of predefined fluids (e.g. various sugar solutions, acids, alkalis, salts, ethanol etc.).
- Common or user-defined units (°Brix, °Plato, % mass, % volume, mol/l etc.) for standard applications.
- Concentration calculation from user-defined tables.

The measured values are output via the digital and analog outputs of the device.



For detailed information, see the Special Documentation for the device.

**Special density**

Order code for "Application package", option EE "Special density"

Many applications use density as a key measured value for monitoring quality or controlling processes. The measuring instrument measures the density of the fluid as standard and makes this value available to the control system.

The "Special Density" application package offers high-precision density measurement over a wide density and temperature range particularly for applications subject to varying process conditions.

The calibration certificate supplied contains the following information:

- Density performance in air
- Density performance in liquids with different density
- Density performance in water with different temperatures



For detailed information, see the Operating Instructions for the device.

**Extended density**

Order code for "Application package", option E1 "Extended density"

For volume-based applications, the device can calculate and output a volume flow rate by dividing the mass flow rate by the measured density.

This application package is the standard calibration for custody transfer applications according to national and international standards (e.g. OIML, MID). It is recommended for volume-based fiscal dosing applications over a wide temperature range.

The calibration certificate supplied describes the density performance in air and water at various temperatures in detail.





For detailed information, see the Operating Instructions for the device.

## Accessories



Various accessories, which can be ordered with the device or subsequently from Endress+Hauser, are available for the device. Detailed information on the order code in question is available from your local Endress+Hauser sales center or on the product page of the Endress+Hauser website: [www.endress.com](http://www.endress.com).



### Device-specific accessories

#### For the sensor



Accessories	Description
Heating jacket	<p>Is used to stabilize the temperature of the fluids in the sensor. Water, water vapor and other non-corrosive liquids are permitted for use as fluids.</p> <p> If using oil as a heating medium, please consult with Endress+Hauser.</p> <p>Heating jackets cannot be used with sensors fitted with a rupture disk.</p> <ul style="list-style-type: none"> <li>▪ If ordered together with the measuring device:                             <ul style="list-style-type: none"> <li>Order code for "Accessory enclosed"                                     <ul style="list-style-type: none"> <li>▪ Option RB "Heating jacket, G 1/2" female thread"</li> <li>▪ Option RC "Heating jacket, G 3/4" female thread"</li> <li>▪ Option RD "Heating jacket, NPT 1/2" female thread"</li> <li>▪ Option RE "Heating jacket, NPT 3/4" female thread"</li> </ul> </li> </ul> </li> <li>▪ If ordered subsequently:                             <ul style="list-style-type: none"> <li>Use the order code with the product root DK8003.</li> </ul> </li> </ul> <p> Special Documentation SD02156D</p>

### Communication-specific accessories



Accessories	Description
Commubox FXA195 HART	<p>For intrinsically safe HART communication with FieldCare via the USB port.</p> <p> Technical Information TI00404F</p>
Commubox FXA291	<p>Connects Endress+Hauser field devices with a CDI interface (= Endress+Hauser Common Data Interface) and the USB port of a computer or laptop.</p> <p> Technical Information TI00405C</p>
HART loop converter HMX50	<p>Is used to evaluate and convert dynamic HART process variables to analog current signals or limit values.</p> <ul style="list-style-type: none"> <li>▪ Technical Information TI00429F</li> <li>▪ Operating Instructions BA00371F</li> </ul>
Wireless HART adapter SWA70	<p>Is used for the wireless connection of field devices. The WirelessHART adapter can be easily integrated into field devices and existing infrastructures, offers data protection and transmission safety and can be operated in parallel with other wireless networks with minimum cabling complexity.</p> <p> Operating Instructions BA00061S</p>
Fieldgate FXA42	<p>Transmission of the measured values of connected 4 to 20 mA analog measuring instruments, as well as digital measuring instruments</p> <ul style="list-style-type: none"> <li>▪ Technical Information TI01297S</li> <li>▪ Operating Instructions BA01778S</li> <li>▪ Product page: <a href="http://www.endress.com/fxa42">www.endress.com/fxa42</a></li> </ul>
Field Xpert SMT50	<p>The Field Xpert SMT50 tablet PC for device configuration enables mobile plant asset management in the non-hazardous areas. It is suitable for commissioning and maintenance staff to manage field instruments with a digital communication interface and to record progress.</p> <p>This tablet PC is designed as an all-in-one solution with a preinstalled driver library and is an easy-to-use, touch-sensitive tool which can be used to manage the field instruments throughout their entire life cycle.</p> <ul style="list-style-type: none"> <li>▪ Technical Information TI01555S</li> <li>▪ Operating Instructions BA02053S</li> <li>▪ Product page: <a href="http://www.endress.com/smt50">www.endress.com/smt50</a></li> </ul>

Field Xpert SMT70	<p>The Field Xpert SMT70 tablet PC for device configuration enables mobile plant asset management in hazardous and non-hazardous areas. It is suitable for commissioning and maintenance staff to manage field instruments with a digital communication interface and to record progress.</p> <p>This tablet PC is designed as an all-in-one solution with a preinstalled driver library and is an easy-to-use, touch-sensitive tool which can be used to manage the field instruments throughout their entire life cycle.</p> <ul style="list-style-type: none"> <li> ■ Technical Information TI01342S</li> <li>■ Operating Instructions BA01709S</li> <li>■ Product page: <a href="http://www.endress.com/smt70">www.endress.com/smt70</a></li> </ul>
Field Xpert SMT77	<p>The Field Xpert SMT77 tablet PC for device configuration enables mobile plant asset management in areas categorized as Ex Zone 1.</p> <ul style="list-style-type: none"> <li> ■ Technical Information TI01418S</li> <li>■ Operating Instructions BA01923S</li> <li>■ Product page: <a href="http://www.endress.com/smt77">www.endress.com/smt77</a></li> </ul>

## Service-specific accessories

Accessories	Description
Applicator	<p>Software for selecting and sizing Endress+Hauser measuring instruments:</p> <ul style="list-style-type: none"> <li>■ Choice of measuring instruments for industrial requirements</li> <li>■ Calculation of all the necessary data for identifying the optimum flowmeter: e.g. nominal diameter, pressure loss, flow velocity and measurement accuracy.</li> <li>■ Graphic display of the calculation results</li> <li>■ Determination of the partial order code, administration, documentation and access to all project-related data and parameters over the entire life cycle of a project.</li> </ul> <p>Applicator is available: Via the Internet: <a href="https://portal.endress.com/webapp/applicator">https://portal.endress.com/webapp/applicator</a></p>
Netilion	<p>IloT ecosystem: Unlock knowledge</p> <p>With the Netilion IloT ecosystem, Endress+Hauser allows you to optimize your plant performance, digitize workflows, share knowledge, and enhance collaboration.</p> <p>Drawing upon decades of experience in process automation, Endress+Hauser offers the process industry an IloT ecosystem designed to effortlessly extract insights from data. These insights allow process optimization, leading to increased plant availability, efficiency, and reliability - ultimately resulting in a more profitable plant.</p> <p><a href="http://www.netilion.endress.com">www.netilion.endress.com</a></p>
FieldCare	<p>FDT-based plant asset management tool from Endress+Hauser.</p> <p>It can configure all intelligent field units in your system and helps you manage them. By using the status information, it is also a simple but effective way of checking their status and condition.</p> <ul style="list-style-type: none"> <li> Operating Instructions BA00027S and BA00059S</li> </ul>
DeviceCare	<p>Tool to connect and configure Endress+Hauser field devices.</p> <ul style="list-style-type: none"> <li> Innovation brochure IN01047S</li> </ul>

## System components

Accessories	Description
Memograph M graphic data manager	<p>The Memograph M graphic data manager provides information on all the relevant measured variables. Measured values are recorded correctly, limit values are monitored and measuring points analyzed. The data are stored in the 256 MB internal memory and also on a SD card or USB stick.</p> <ul style="list-style-type: none"> <li> ■ Technical Information TI00133R</li> <li>■ Operating Instructions BA00247R</li> </ul>
iTEMP	<p>The temperature transmitters can be used in all applications and are suitable for the measurement of gases, steam and liquids. They can be used to read in the medium temperature.</p> <ul style="list-style-type: none"> <li> "Fields of Activity" document FA00006T</li> </ul>

## Supplementary documentation



For an overview of the scope of the associated Technical Documentation, refer to the following:

- *Device Viewer* ([www.endress.com/deviceviewer](http://www.endress.com/deviceviewer)): Enter the serial number from the nameplate
- *Endress+Hauser Operations app*: Enter serial number from nameplate or scan matrix code on nameplate.

### Standard documentation



Supplementary information on the semi-standard options is available in the relevant Special Documentation in the TSP database.

### Brief Operating instructions

*Brief Operating Instructions for the sensor*

Measuring instrument	Documentation code
Proline Promass F	KA01261D

*Brief operating instructions for transmitter*

Measuring instrument	Documentation code		
	HART PROFIBUS DP	Modbus RS485	EtherNet/IP PROFINET
Proline Promass 100	KKA01333D	KA01335D	KKA01336D

### Operating Instructions

Measuring device	Documentation code				
	HART	PROFIBUS DP	Modbus RS485	EtherNet/IP	PROFINET
Promass F 100	BA01168D	BA01249D	BA01057D	BA01065D	BA01427D

### Description of device parameters

Measuring device	Documentation code				
	HART	PROFIBUS DP	Modbus RS485	EtherNet/IP	PROFINET
Promass 100	GP01033D	GP01034D	GP01035D	GP01036D	GP01037D

### Supplementary device-dependent documentation

### Safety Instructions

Content	Documentation code
ATEX/IECEX Ex i	XA00159D
ATEX/IECEX Ex nA	XA01029D

Content	Documentation code
cCSAus IS	XA00160D
INMETRO Ex i	XA01219D
INMETRO Ex nA	XA01220D
NEPSI Ex i	XA01249D
NEPSI Ex nA	XA01262D

### Special Documentation

Content	Documentation code
Information on the Pressure Equipment Directive	SD00142D
Modbus RS485 Register Information	SD00154D
Concentration measurement	SD01152D
Concentration measurement	SD01503D
Heartbeat Technology	SD01153D
Heartbeat Technology	SD01493D
Web server	SD01820D
Web server	SD01821D
Web server	SD01822D
Web server	SD01823D

### Installation instructions

Contents	Note
Installation instructions for spare part sets and accessories	Documentation code: specified for each individual accessory → 101.

## Registered trademarks

### HART®

Registered trademark of the FieldComm Group, Austin, Texas USA

### PROFIBUS®

Registered trademark of the PROFIBUS Nutzerorganisation e.V. (PROFIBUS User Organization), Karlsruhe, Germany

### Modbus®

Registered trademark of SCHNEIDER AUTOMATION, INC.

### EtherNet/IP™

Trademark of ODVA, Inc.

### PROFINET®

Registered trademark of the PROFIBUS Nutzerorganisation e.V. (PROFIBUS User Organization), Karlsruhe, Germany

### TRI-CLAMP®

Registered trademark of Ladish & Co., Inc., Kenosha, USA



---



[www.addresses.endress.com](http://www.addresses.endress.com)

---