

Operating Instructions

OUSAF46

Optical sensor with the OUA260 flow assembly for the measurement of UV absorption







Table of contents









1	About this document	3	9.2	Spare parts	30
1.1	Safety information	3	9.3	Return	30
1.2	Symbols	3	9.4	Disposal	31
1.3	Symbols on the product	3			
2	Basic safety instructions	4	10	Accessories	31
2.1	Requirements for the personnel	4	10.1	Flow assembly	31
2.2	Intended use	4	10.2	Cables	32
2.3	Workplace safety	4	10.3	Calibration	32
2.4	Operational safety	4			
2.5	Product safety	5	11	Technical data	32
3	Product description	6	11.1	Input	32
3.1	Measuring principle	6	11.2	Environment	33
			11.3	Process	33
			11.4	Mechanical construction	33
4	Incoming acceptance and product identification	7			
4.1	Incoming acceptance	7	Index		35
4.2	Product identification	7			
4.3	Manufacturer address	8			
4.4	Scope of delivery	8			
5	Mounting	8			
5.1	Mounting requirements	8			
5.2	Mounting the sensor	11			
5.3	Post-mounting check	12			
6	Electrical connection	12			
6.1	Connecting the sensor	13			
6.2	Lamp voltage	14			
6.3	Ensuring the degree of protection	14			
6.4	Post-connection check	15			
7	Commissioning	16			
7.1	Function check	16			
7.2	Calibrating/adjusting the sensor	16			
8	Maintenance	18			
8.1	Maintenance schedule	19			
8.2	Replacing the hazardous area lamp	19			
8.3	Replacing the mercury lamp	19			
8.4	Replacing the reference filter	22			
8.5	Replacing the measurement filter	24			
8.6	Replacing the sensor window and seal	28			
9	Repair	30			
9.1	General notes	30			

1 About this document

1.1 Safety information

Structure of information	Meaning
<p> DANGER</p> <p>Causes (/consequences) If necessary, Consequences of non-compliance (if applicable)</p> <ul style="list-style-type: none"> ▶ Corrective action 	<p>This symbol alerts you to a dangerous situation. Failure to avoid the dangerous situation will result in a fatal or serious injury.</p>
<p> WARNING</p> <p>Causes (/consequences) If necessary, Consequences of non-compliance (if applicable)</p> <ul style="list-style-type: none"> ▶ Corrective action 	<p>This symbol alerts you to a dangerous situation. Failure to avoid the dangerous situation can result in a fatal or serious injury.</p>
<p> CAUTION</p> <p>Causes (/consequences) If necessary, Consequences of non-compliance (if applicable)</p> <ul style="list-style-type: none"> ▶ Corrective action 	<p>This symbol alerts you to a dangerous situation. Failure to avoid this situation can result in minor or more serious injuries.</p>
<p> NOTICE</p> <p>Cause/situation If necessary, Consequences of non-compliance (if applicable)</p> <ul style="list-style-type: none"> ▶ Action/note 	<p>This symbol alerts you to situations which may result in damage to property.</p>

1.2 Symbols

-  Additional information, tips
-  Permitted
-  Recommended
-  Not permitted or not recommended
-  Reference to device documentation
-  Reference to page
-  Reference to graphic
-  Result of an individual step

1.3 Symbols on the product

-  Reference to device documentation
-  Do not dispose of products bearing this marking as unsorted municipal waste. Instead, return them to the manufacturer for disposal under the applicable conditions.

2 Basic safety instructions

2.1 Requirements for the personnel

- Installation, commissioning, operation and maintenance of the measuring system may be carried out only by specially trained technical personnel.
- The technical personnel must be authorized by the plant operator to carry out the specified activities.
- The electrical connection may be performed only by an electrical technician.
- The technical personnel must have read and understood these Operating Instructions and must follow the instructions contained therein.
- Faults at the measuring point may only be rectified by authorized and specially trained personnel.

 Repairs not described in the Operating Instructions provided must be carried out only directly at the manufacturer's site or by the service organization.

2.2 Intended use

The sensor measures the spectral absorption of process liquids in the ultraviolet region of the electromagnetic spectrum. The sensor is suitable for use in a wide range of applications in a variety of industrial sectors, such as:

- Measurement of protein concentrations
- Chromatography monitoring
- Filtration monitoring
- Concentration measurement of organic compounds
- Detection of aromates

Any use other than that intended puts the safety of people and the measuring system at risk. Therefore, any other use is not permitted.

The manufacturer is not liable for harm caused by improper or unintended use.

2.3 Workplace safety

The operator is responsible for ensuring compliance with the following safety regulations:

- Installation guidelines
- Local standards and regulations
- Regulations for explosion protection

Electromagnetic compatibility

- The product has been tested for electromagnetic compatibility in accordance with the applicable international standards for industrial applications.
- The electromagnetic compatibility indicated applies only to a product that has been connected in accordance with these Operating Instructions.

2.4 Operational safety

Before commissioning the entire measuring point:

1. Verify that all connections are correct.

2. Ensure that electrical cables and hose connections are undamaged.
3. Do not operate damaged products, and protect them against unintentional operation.
4. Label damaged products as defective.

During operation:

- ▶ If faults cannot be rectified,
take products out of service and protect them against unintentional operation.

2.5 Product safety

⚠ CAUTION**Mercury lamp**

Can cause damage to the eyes and skin!

- ▶ Avoid any exposure of the eyes and skin to the unshielded product.
- ▶ Wear suitable protective goggles to protect against UV radiation.

⚠ CAUTION**Mercury lamp breakage**

Possible injury due to inhalation of released mercury!

- ▶ If inhaled, move the person to fresh air and ensure their breathing is unobstructed.
- ▶ Observe the safety data sheet of the lamp manufacturer.

2.5.1 State of the art

The product is designed to meet state-of-the-art safety requirements, has been tested, and left the factory in a condition in which it is safe to operate. The relevant regulations and international standards have been observed.

2.5.2 Versions with hazardous area lamp

- ▶ Observe the safety instructions in the XA pertaining to this manual.



Safety instructions for electrical equipment in hazardous areas, photometer sensors, XA01403C

3 Product description

3.1 Measuring principle

Light absorption

The measuring principle is based on the Lambert-Beer law.

There is a linear dependency between the absorption of light and the concentration of the absorbing substance:

$$A = -\log(T) = \varepsilon \cdot c \cdot OPL$$

$$T = I/I_0$$

T ... Transmission

I ... Intensity of received light at detector

I₀ ... Intensity of transmitted light of light source

A ... Absorption

ε ... Extinction coefficient

c ... Concentration

OPL ... Optical path length

A light source emits radiation through the medium and the incident radiation is measured on the detector side.

The subsequent conversion to absorbance units (AU, OD) is performed in the associated transmitter.

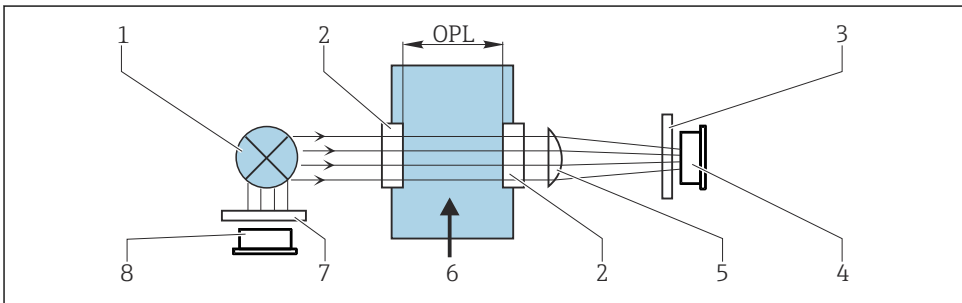

A0029412

1 Absorption measurement with reference

- 1 Light source
- 2 Optical windows
- 3 Measurement filter
- 4 Measuring detector
- 5 Lens
- 6 Medium flow
- 7 Reference filter
- 8 Reference detector

i OUSAF46 has 2 pairs of reference and measuring detectors (= 2 channels). Only one channel is shown for the sake of simplicity.

4 Incoming acceptance and product identification

4.1 Incoming acceptance

1. Verify that the packaging is undamaged.
 - ↳ Notify the supplier of any damage to the packaging.
Keep the damaged packaging until the issue has been resolved.
2. Verify that the contents are undamaged.
 - ↳ Notify the supplier of any damage to the delivery contents.
Keep the damaged goods until the issue has been resolved.
3. Check that the delivery is complete and nothing is missing.
 - ↳ Compare the shipping documents with your order.
4. Pack the product for storage and transportation in such a way that it is protected against impact and moisture.
 - ↳ The original packaging offers the best protection.
Make sure to comply with the permitted ambient conditions.

If you have any questions, please contact your supplier or your local Sales Center.

4.2 Product identification

4.2.1 Nameplate

The nameplate provides you with the following information on your device:

- Manufacturer identification
 - Order code
 - Serial number
 - Safety information and warnings
- ▶ Compare the information on the nameplate with the order.

4.2.2 Identifying the product

Product page

www.endress.com/ousaf46

Interpreting the order code

The order code and serial number of your product can be found in the following locations:

- On the nameplate
- In the delivery papers

Obtaining information on the product

1. Go to www.endress.com.
2. Page search (magnifying glass symbol): Enter valid serial number.

3. Search (magnifying glass).
 - ↳ The product structure is displayed in a popup window.
4. Click the product overview.
 - ↳ A new window opens. Here you fill information pertaining to your device, including the product documentation.

4.3 Manufacturer address

Endress+Hauser Conducta Inc.
4123 East La Palma Avenue, Suite 200
Anaheim, CA 92807 USA

4.4 Scope of delivery

The scope of delivery comprises the following, :

- Detector and lamp module without flow assembly or
 - Detector and lamp module mounted on flow assembly
 - Operating Instructions
- ▶ If you have any queries:
Please contact your supplier or local sales center.

5 Mounting

5.1 Mounting requirements

5.1.1 Measuring system

An optical measuring system comprises:

- Sensor (photometer) OUSAF46
- Transmitter, e. g. Liquiline CM44P
- Cable set, e. g. CUK80
- Assembly OUA260

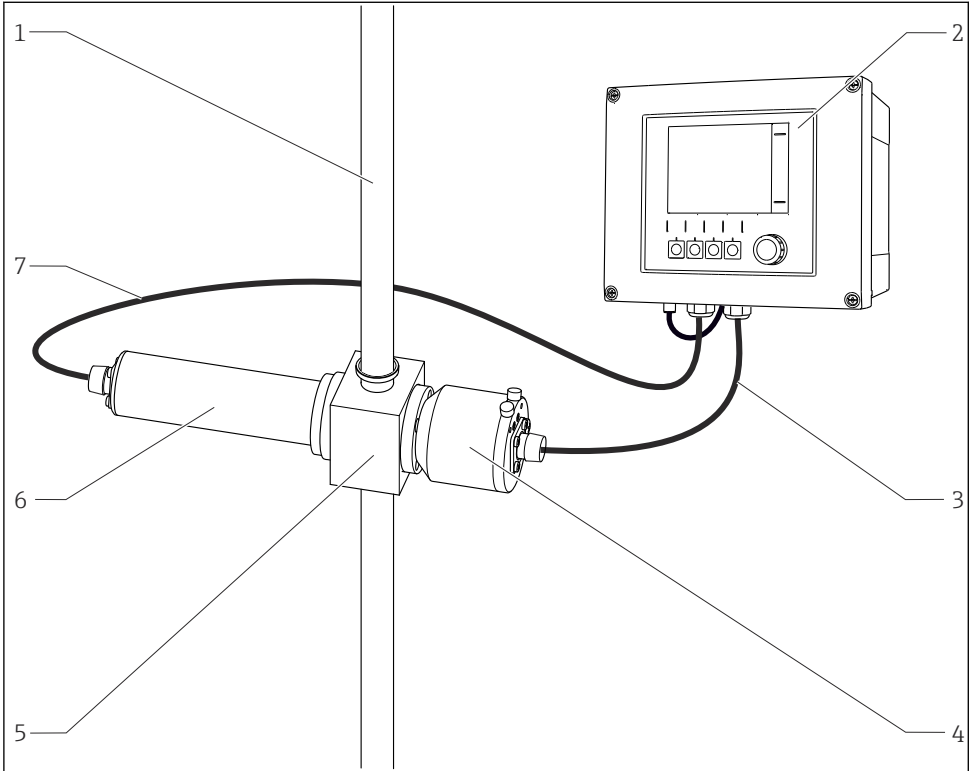

2 Example of a measuring system with a photometer sensor

- | | | | |
|---|-------------------|---|-----------------------------|
| 1 | Pipe | 5 | Flow assembly OUA260 |
| 2 | Transmitter CM44P | 6 | Sensor: light source (lamp) |
| 3 | CUK80 cable set | 7 | CUK80 cable set |
| 4 | Sensor: detector | | |

5.1.2 Dimensions

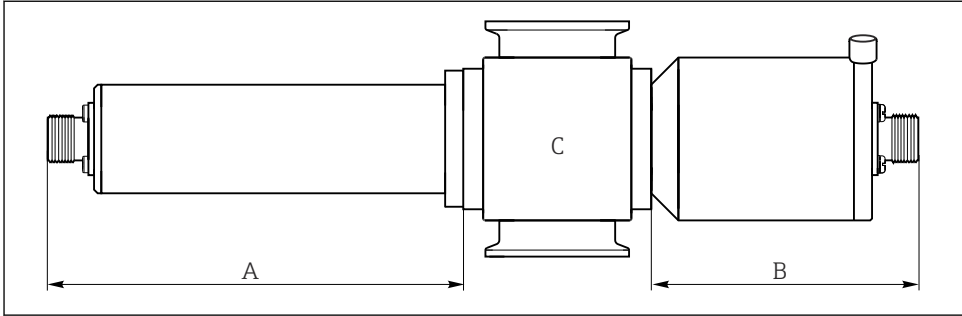

A0035258

3 Sensor module

- A Dimension of lamp → Table
 B Dimension of detector → Table
 C Assembly; see Technical Information for assembly

Lamp type	Dimension A in mm (inch)
Standard lamp	146.1 (5.75)
Detector type	Dimension B in mm (inch)
Standard version with test filter	102.8 (4.05) 80 (3.15)
Easycal	94 (3.70)

 The total length of the sensor module is derived from the lengths of the lamp, the detector and the assembly.

The dimensions of the OUA260 assembly are provided in Technical Information, TI00418C.

- ▶ Allow an additional gap of 5 cm (2") on both the lamp side and detector side of the sensor to connect the sensor cable.

5.1.3 Mounting angle

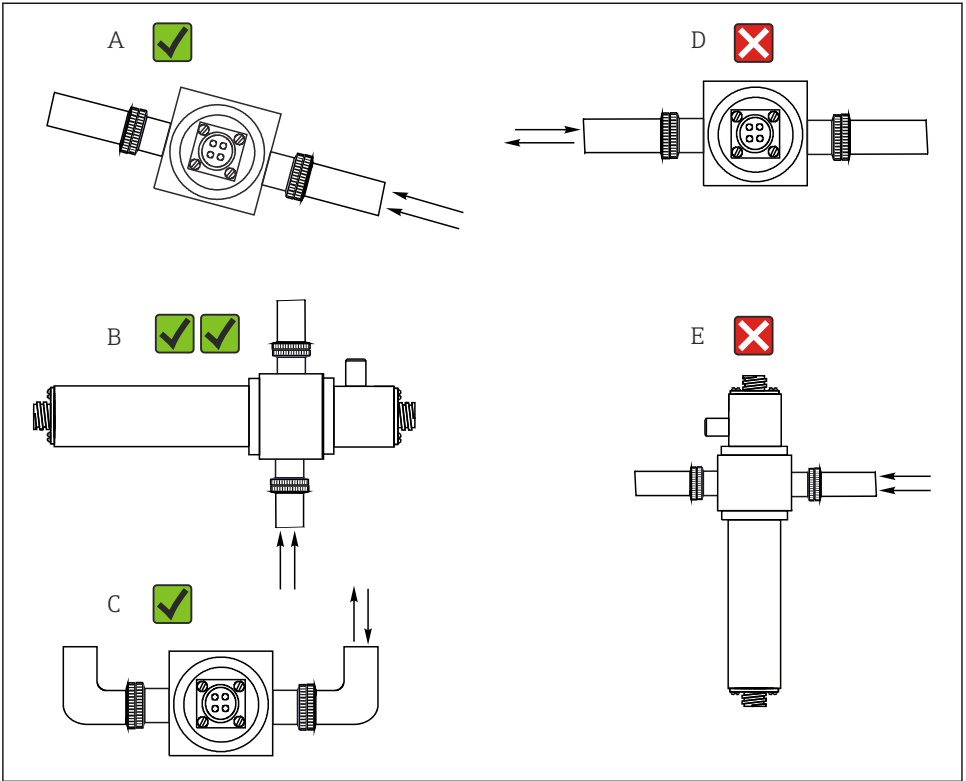

A0028250

4 Mounting angles. The arrows indicate the direction of medium flow in the pipe.

- A Suitable mounting angle, better than C
- B Optimum mounting angle, best installation position
- C Acceptable mounting angle
- D Mounting angle to be avoided
- E Forbidden mounting angle

5.2 Mounting the sensor

The sensors have been specifically designed so that they can be installed in the process together with a flow assembly, such as the OUA260. The flow assembly can be installed either directly in a process line or in a bypass line.

The sensor cannot be used without an assembly.

- ▶ Make sure that the sensor housing and detector housing are aligned horizontally. This ensures that the optical windows are vertically aligned as this prevents buildup on the window surfaces.

- ▶ Install the sensor upstream from the pressure regulators.
- ▶ Leave enough room for the cable connector at the end of the lamp and at the end of the detector housing. Unimpeded access to these areas is also required for connection/removal tasks.
- ▶ The operation of sensors under pressure prevents the formation of air or gas bubbles.

NOTICE

Mounting errors

Possibility of sensor damage, twisted cables or similar

- ▶ Make sure that the sensor bodies are protected against damage from external forces - such as trolleys on adjacent paths.
- ▶ Remove the cable before you screw the lamp or detector onto the flow assembly.
- ▶ Make sure to avoid exerting excessive tensile force on the cable (e.g. from jerky pulling movements).
- ▶ Make sure to observe the national grounding regulations when using metal assemblies.

If the sensor is ordered together with the assembly OUA260, the flow assembly is ready-mounted on the sensor upon delivery. The sensor is ready for use immediately.

If the sensor and assembly are ordered separately, you must mount the sensor as follows:

1. Install flow assembly OUA260 in the process via the process connections.
2. Make sure to fit the O-ring seals on the lamp and detector.
Screw the lamp and detector onto the flow assembly.



The lamp and detector can be installed in and removed from the assembly without this affecting the process line.

5.3 Post-mounting check

Put the sensor into operation only if you can answer "yes" to the following questions:

- Are the sensor and cable undamaged?
- Have you chosen a correct mounting angle?

6 Electrical connection

⚠ WARNING

Device is live!

Incorrect connection may result in injury or death!

- ▶ The electrical connection may be performed only by an electrical technician.
- ▶ The electrical technician must have read and understood these Operating Instructions and must follow the instructions contained therein.
- ▶ **Prior** to commencing connection work, ensure that no voltage is present on any cable.

6.1 Connecting the sensor

The sensor is connected to the transmitter via the pre-terminated or labeled CUK80 cable set. The terminals and labeling may vary depending on the transmitter in use. The cable set must be ordered separately.

- ▶ Do not shorten or change the CUK80 cable!

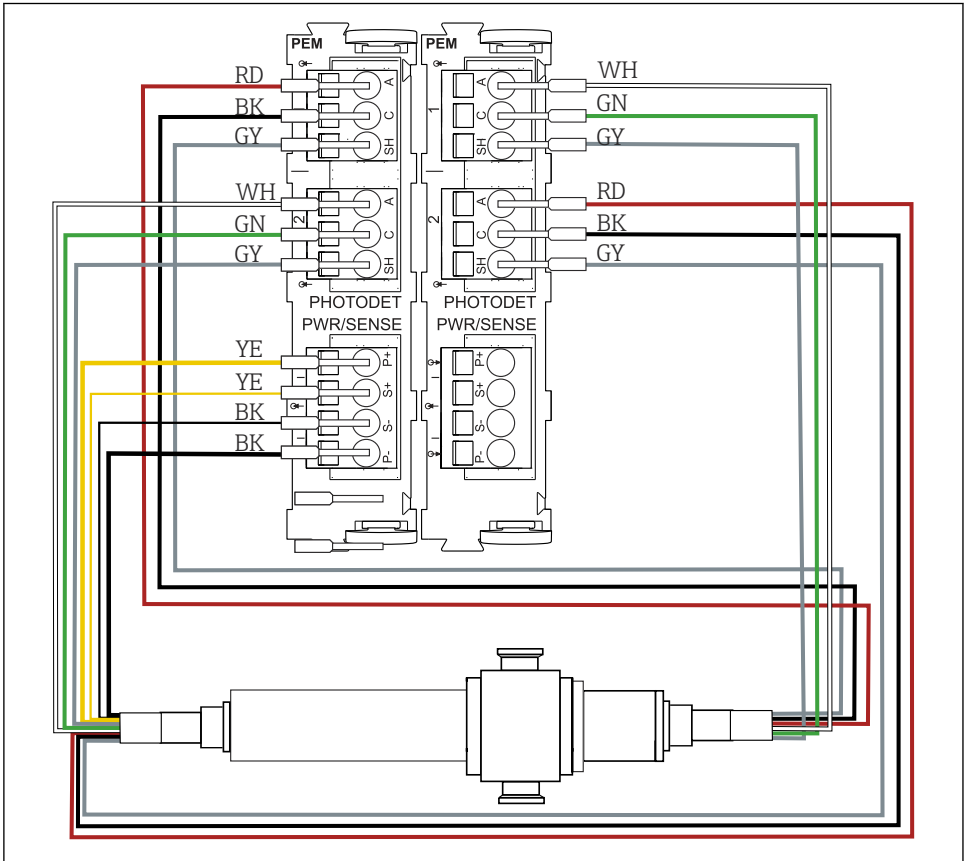

A0046701

5 Connecting OUSAF46 to CM44P (2 PEM modules needed)

CM44P terminal	Cable color	Assignment
PEM module 1		
P+	YE (thick)	Lamp voltage +
S+	YE (thin)	Detection of lamp voltage +
S-	BK (thin)	Detection of lamp voltage -
P-	BK (thick)	Lamp voltage -
A (1)	RD	Channel 1 Sensor measuring detector +
C(1)	BK	Channel 1 Sensor measuring detector -
SH (1)	GY	Channel 1 Shield
A (2)	WH (lamp)	Channel 1 Sensor reference +
C(2)	GN (lamp)	Channel 1 Sensor reference -
SH (2)	GY (lamp)	Channel 1 Shield
PEM module 2		
A (1)	WH	Channel 2 Sensor measuring detector +
C(1)	GN	Channel 2 Sensor measuring detector -
SH (1)	GY	Channel 2 Shield
A (2)	RD (lamp)	Channel 2 Sensor reference +
C(2)	BK (lamp)	Channel 2 Sensor reference -
SH (2)	GY (lamp)	Channel 2 Shield

6.2 Lamp voltage

Sensor version	Lamp type	Lamp voltage [V]
OUSA46-xxxx	Low-pressure mercury lamp	10.0 ± 0.1

6.3 Ensuring the degree of protection

Only the mechanical and electrical connections which are described in these instructions, and which are necessary for the required intended use, may be established on the device delivered.

- Exercise care when carrying out the work.

Individual types of protection permitted for this product (impermeability (IP), electrical safety, EMC interference immunity, explosion protection) can no longer be guaranteed if, for example:

- Covers are left off
- Different power units to the ones supplied are used
- Cable glands are not sufficiently tightened (must be tightened with 2 Nm (1.5 lbf ft) for the permitted level of IP protection)

- Unsuitable cable diameters are used for the cable glands
- Modules are not fully secured
- The display is not fully secured (risk of moisture entering due to inadequate sealing)
- Cables/cable ends are loose or insufficiently tightened
- Conductive cable strands are left in the device

6.4 Post-connection check

Device condition and specifications	Notes
Are the sensor, assembly and cable free from damage on the outside?	Visual inspection

Electrical connection	Notes
Does the supply voltage of the connected transmitter match the data on the nameplate?	Visual inspection
Are the installed cables strain-relieved and not twisted?	
Has the cable been routed without loops and cross-overs?	Check that it is firmly seated (by pulling gently)
Are the signal cables connected correctly according to the connection diagram?	
Are all cable entries mounted, tightened and leak-tight?	For lateral cable entries, make sure the cables loop downwards to allow water to drip off.
Are the PE distributor rails grounded (if present)?	Grounding at the point of installation

7 Commissioning

7.1 Function check

Prior to initial commissioning, ensure that:

- The sensor is correctly installed
- The electrical connection is correct

7.2 Calibrating/adjusting the sensor

Measuring points consisting of a photometer sensor, flow assembly (if provided) and a transmitter are adjusted at the factory. Normally adjustment is not required when commissioning for the first time.

If an adjustment is desired nevertheless, you have the following adjustment options:

- Adjustment with calibration standards
- Use of Easycal

7.2.1 Calibration/adjustment with standard solutions

Use solutions with a known absorbance (at the sensor wavelength) for the calibration/adjustment.

WARNING

Potassium dichromate is toxic, flammable, carcinogenic and has mutagenic effects!

Can cause cancer, genetic defectives, affect fertility, harm the unborn child and intensify fires. Potentially life-threatening if inhaled, toxic if swallowed, harmful if it comes into contact with skin. Causes severe skin burns and severe eye damage!

- ▶ When working with potassium dichromate, always wear protective gloves and protective goggles.
- ▶ Seek special advice before use.
- ▶ Follow all of the instructions on the manufacturer's safety data sheet.

Use calibration solutions that are suitable for the measuring task. Examples of solutions which are commonly used include:

Potassium dichromate, $K_2Cr_2O_7$

A solution of 182 ml 0.1N $K_2Cr_2O_7$, diluted to one liter, has an absorbance of approx. 10 OD at 280 nm. By diluting the solution, you can produce a series of calibration solutions which you can use to adjust the measuring point.

$$AU = OD \cdot OPL [\text{cm}]$$

AU ... absorbance units, OD ... optical density, OPL ... optical path length

 Instead of potassium dichromate you can also use your process medium for calibrating/adjusting and for application calibration. Here, also produce a series of dilutions of known concentration and determine the absorbance in the laboratory.

7.2.2 Easycal

Easycal enables you to perform a calibration/an adjustment which is traceable to NIST without any liquid standards.

Detector with Easycal: function

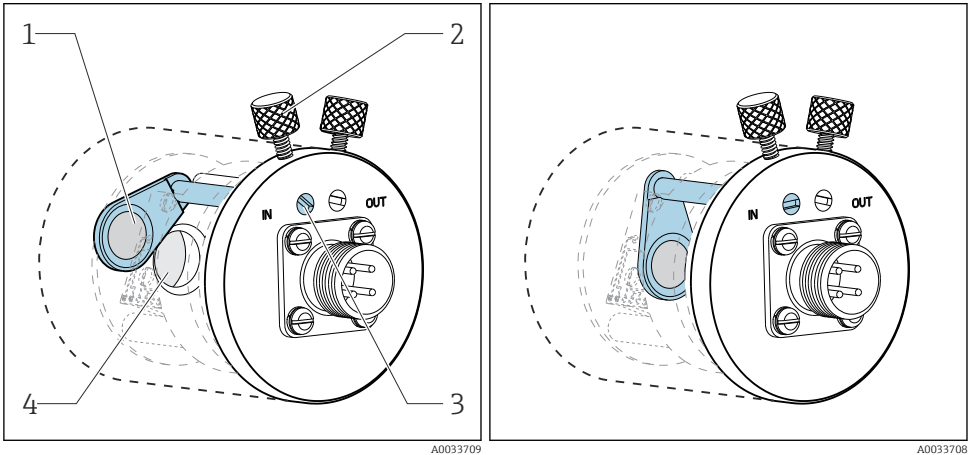

6 Filter in "out" position

- 1 NIST-traceable filter (high)
- 2 Locking screw

7 Filter in "in" position

- 3 Positioning pin
- 4 Lens assembly

Every Easycal device has two traceable filters - one filter with a nominal 0.5 AU and another filter with 1 AU (absorbance unit) - which are placed individually or together in the device measuring path. These filter(s) are scanned with traceable testing equipment and the actual absorbance at individual wavelengths is determined.

It is very important that you use the actual values of the optical Easycal filter. These values are given in the calibration certificate supplied.

- ▶ Enter the absorbance values (CM44P): **Menu/Setup/Inputs/Photometer/Extended setup/Measurement channel/Calib. settings/EasyCal = Yes, NIST filter high and NIST filter low.**

i Send Easycal in to your Service Center once a year for recertification. This comprises complete functional testing and the recertification of the filters in accordance with sources that are traceable to NIST.

7.2.3 Visual inspection

A reference rod is included in the delivery for every standard sensor (sensor without Easycal). In this way, it is possible to perform a functional test on the device without having to use calibration solutions.

The reference rod is screwed into the sensor detector housing, thereby partially blocking the sensor light. This simulates the absorbance in the optical chain.

The cross-sectional view of the measuring detector below illustrates the position of the reference rod and its blocking effect.

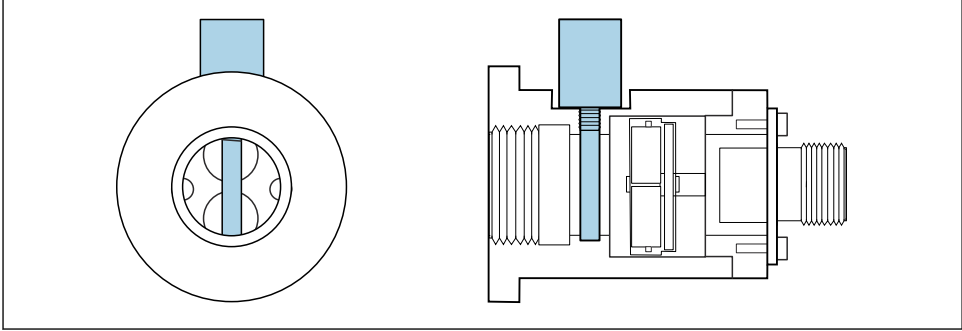

A0035261

 8 Cross-section of detector module with reference rod inserted

Proceed as follows to obtain a value for the reference rod during commissioning:

1. Fill the flow assembly with water. Make sure that the measured value "zero" is displayed.
2. Insert the reference rod into the detector housing.
 - ↳ Make a note of the measured value.

You can check the calibration any time later on by filling the flow assembly with water again and re-inserting the reference rod. The measured value should be equal to the value noted down.

8 Maintenance

Take all the necessary precautions in time to ensure the operational safety and reliability of the entire measuring system.

NOTICE

Effects on process and process control!

- ▶ When carrying out any work on the system, bear in mind any potential impact this could have on the process control system and the process itself.
- ▶ For your own safety, only use genuine accessories. With genuine parts, the function, accuracy and reliability are also ensured after maintenance work.

NOTICE**Sensitive optical components**

If you do not proceed with care, you can damage or severely dirty the optical components.

- ▶ Maintenance work may only be carried out by appropriately qualified staff.
- ▶ Use ethanol and a lint-free cloth which is suitable for cleaning lenses to clean all the optical components.

8.1 Maintenance schedule

- Maintenance and servicing intervals are based on the individual application.
- Cleaning intervals depend on the medium.

Maintenance checklist

- Replace lamp
The lamp is typically replaced after 1000 to 3000 operating hours (→  34).
- Replace sensor window and seal
The window only needs to be replaced if it is damaged.
- Replace O-rings in contact with the medium
The replacement of O-rings in contact with the medium depends on the specific requirements of the process.
Never re-use a used O-ring.

8.2 Replacing the hazardous area lamp

The disassembly and assembly process for the hazardous area lamp is the same as for the non-hazardous area version.



Make sure you use the right spare parts kit.

8.3 Replacing the mercury lamp

⚠ WARNING**Dangerous voltage**

Risk of serious or fatal injury from electric shock!

- ▶ Before performing any maintenance work on the lamp, remove all the cables and disconnect the power supply to the sensor.
- ▶ Only replace the lamp in a current-free state.

⚠ CAUTION**Mercury lamp**

Can cause damage to the eyes and skin!

- ▶ Avoid any exposure of the eyes and skin to the unshielded product.
- ▶ Wear suitable protective goggles to protect against UV radiation.

⚠ CAUTION**Mercury lamp breakage**

Possible injury due to inhalation of released mercury!

- ▶ If inhaled, move the person to fresh air and ensure their breathing is unobstructed.
- ▶ Observe the safety data sheet of the lamp manufacturer.

Removing the used lamp

- ▶ Switch off the lamp using the software function on the transmitter.
- ▶ Remove the lamp cable.
- ▶ Allow the lamp to cool down (30 minutes).

1.

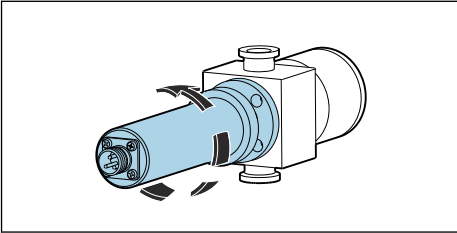

Turn the lamp module counterclockwise to remove it from the flow assembly.

2.

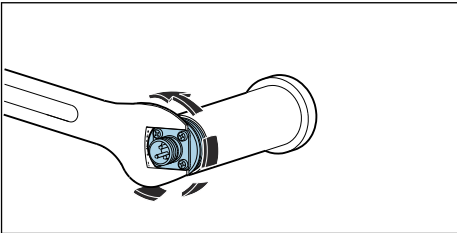

Use a 1" open-ended wrench. With the wrench, hold the base plate of the cable connector in position and unscrew the lamp housing in a counterclockwise direction by hand.

- ↳ Remove the lamp and reflector unit from the housing.

3.

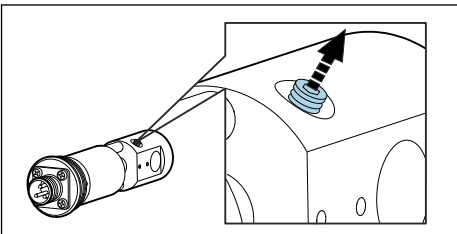

Loosen the securing screw holding the lamp by 1-2 rotations.

4.

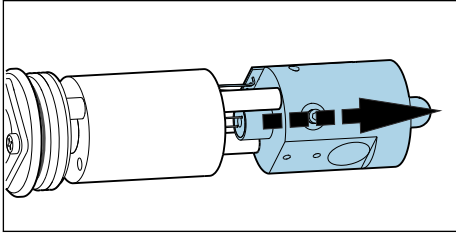

Hold the lamp socket in the gap between the lamp power supply unit and the reflector and press it out of its fitting. Do not damage the cable of the circuit board! Then press the lamp out completely through the reflector.

- ↳ Dispose of the used lamp in accordance with local regulations for lamps containing mercury.

5.

Check whether the cables of the lamp module are worn, or whether the reflector is damaged.

Inserting a new lamp

When working with the lamp, use a cloth for lenses or wear talc-free latex gloves.

1.

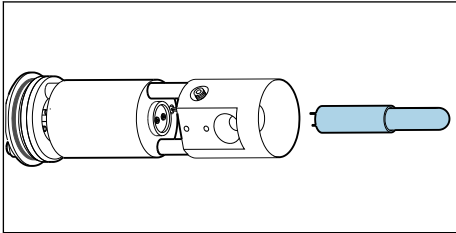

Clean the new lamp and the reflector with ethanol and a cloth for cleaning the lens.

- ↳ Do not touch optical surfaces once they have been cleaned!

2.

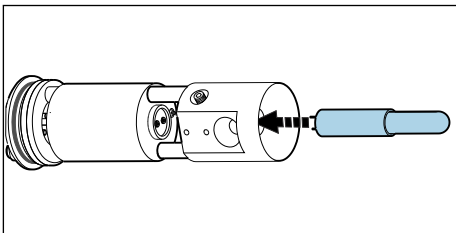

Guide the new lamp carefully through the reflector and into the socket.

- ↳ Make sure that the lamp is securely seated in the correct position.

3.

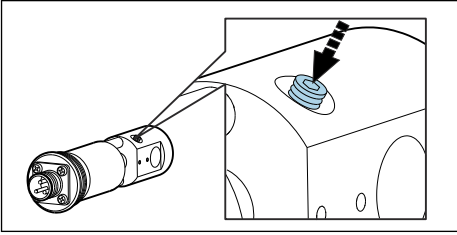

Retighten the securing screw.

- ↳ This screw is only used to hold the lamp in position. Therefore, do not tighten it too tightly as to do so could damage or break the lamp.

4.

Make sure that the lamp contact area is completely clean and dry before re-closing.

5.

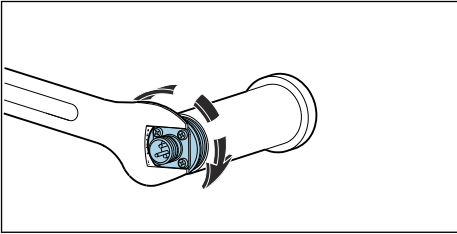

Screw the lamp and reflector group back into its housing and tighten it by hand.

6.

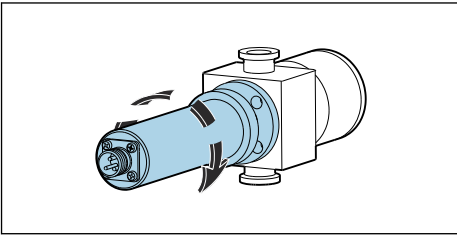

Mount the complete lamp module back into the flow assembly.

After replacing the lamp, the system needs to be adjusted. In addition, you must reset the operating hours counter for the lamp on the CM44P: **CAL/Photometer/Lamp operating time/Reset**.

8.4 Replacing the reference filter

⚠ WARNING

Dangerous voltage

Risk of serious or fatal injury from electric shock!

- ▶ Before performing any maintenance work on the lamp, remove all the cables and disconnect the power supply to the sensor.
- ▶ Only replace the filter in a current-free state.

⚠ CAUTION**Mercury lamp**

Can cause damage to the eyes and skin!

- ▶ Avoid any exposure of the eyes and skin to the unshielded product.
- ▶ Wear suitable protective goggles to protect against UV radiation.

⚠ CAUTION**Mercury lamp breakage**

Possible injury due to inhalation of released mercury!

- ▶ If inhaled, move the person to fresh air and ensure their breathing is unobstructed.
- ▶ Observe the safety data sheet of the lamp manufacturer.

- ▶ Switch off the lamp using the software function on the transmitter.
- ▶ Remove the lamp cable.
- ▶ Allow the lamp to cool down (30 minutes).
- ▶ Remove the lamp module from the flow assembly, disassemble the lamp housing and remove the lamp and reflector unit from the housing. Proceed in the exact same way as described for replacing the mercury lamp. → 📄 20

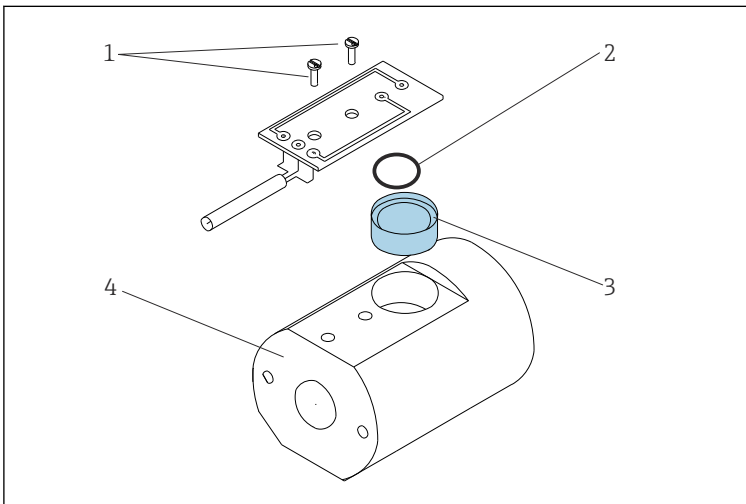
**📄 9 Replacing the reference filter**

- 1 Screw on circuit board
- 2 O-ring
- 3 Reference filter
- 4 Lamp holder

1. Remove both screws (item 1), and release the circuit board from the lamp holder (item 4).
2. Turn over the lamp holder and allow the filter (item 3) to fall into your hand.

3. Insert the new filter. In doing so, make sure that the "reflective" side is facing towards the light source. Use the correct filter (reference filter) from the spare parts kit!
4. Fit the circuit board back on and tighten the screws slightly.
5. Reassemble the lamp module and mount it back on the assembly.

You must then recalibrate/readjust the measuring system.

In addition, you must reset the counter for filter replacement in the case of the CM44P: **CAL/Photometer/Filter change/Reset**

8.5 Replacing the measurement filter

Versions with Easycal:

If the Easycal detector module is sent in for recertification, a diagnostic scan of the measurement filter is performed and the measurement filter is replaced if necessary.

Do not replace the filter yourself.

Versions with a standard detector

Please note that the measurement filters are not identical. Their arrangement in the measuring channels must correspond to the arrangement of the reference filters in the lamp. Measuring channel 1 is always reserved for the filter with the wavelength 280 nm.

The wavelength is indicated on the socket of the filters. In addition, the measuring channels are marked on the bottom of the detector module on leaving the factory.

To avoid any confusion, replace the filters one after the other.

1.

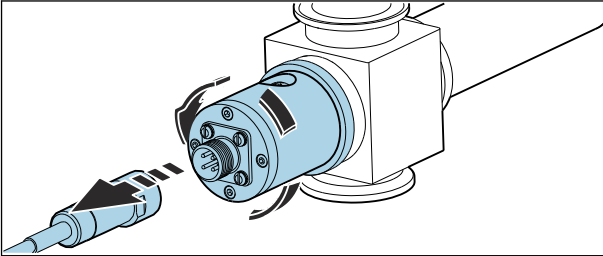

Release sensor cable from detector and unscrew detector from flow assembly.

2.

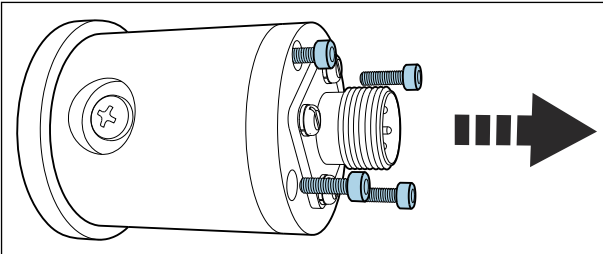

Release the four screws holding the detector housing.

3.

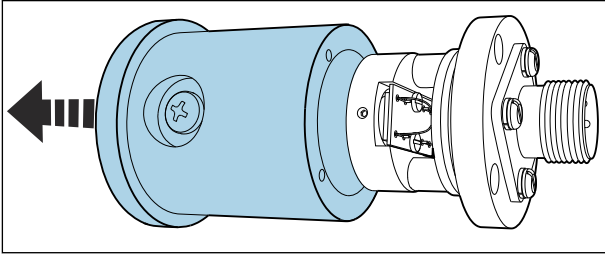

Remove housing along with lens assembly.

4.

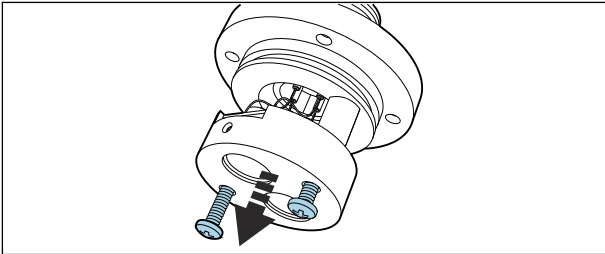

Release two anodized (black) screws.

5.

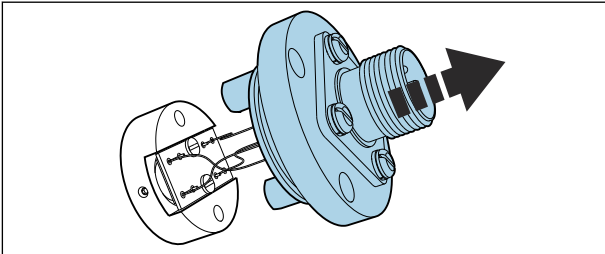

Carefully pull apart. Do not damage or break wires!

6.

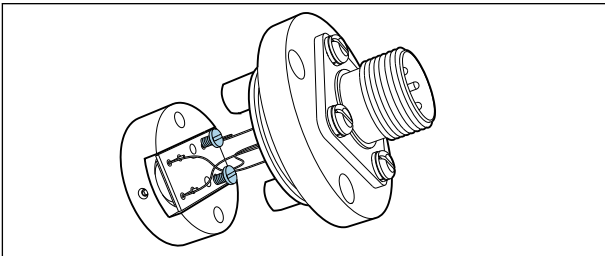

Release screws on board.

7.

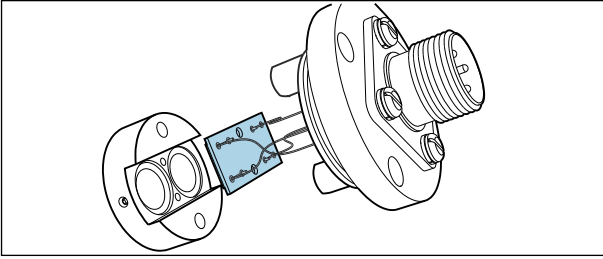

Remove board.

8.

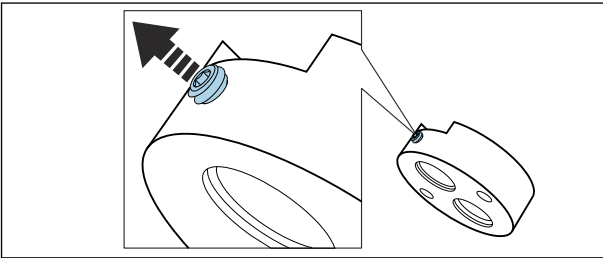

Loosen securing screw.

9.

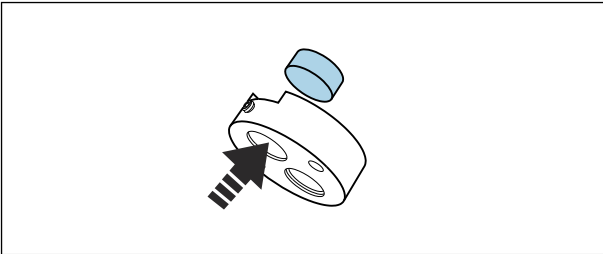

Press out filter.

↳ The wavelength of the filter is indicated on the socket.

10.

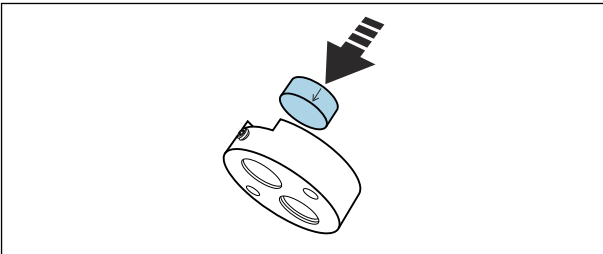

Use filters that have the same wavelength.

↳ The arrow on the socket indicates the installation direction.

11.

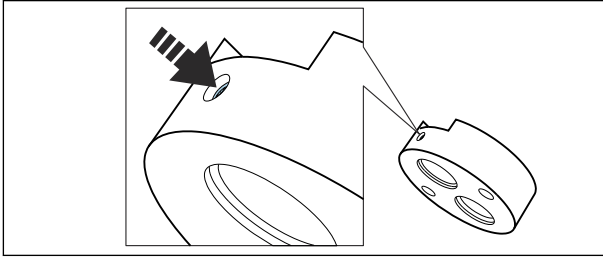

Tighten securing screw for filter.

12.

2. Replace the measurement filter in the same way (release screw, press out filter, insert new filter, tighten screw).

13.

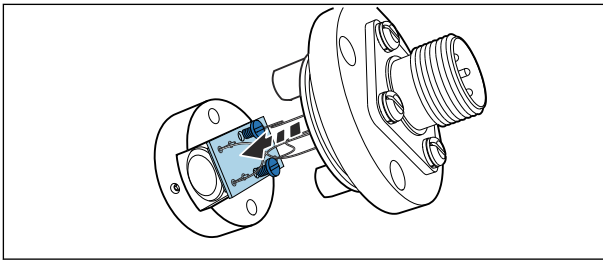

Re-install board. Pay attention to wires.

14.

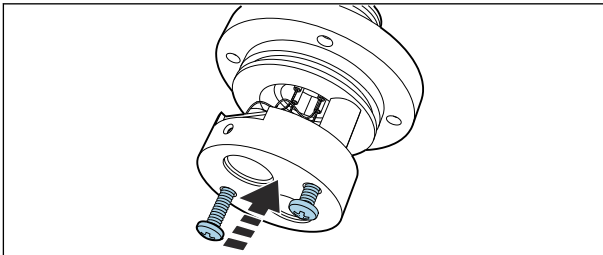

Re-secure the filter holder using the two anodized screws.

15.

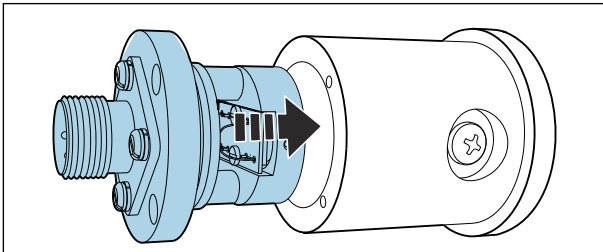

Insert the entire assembly into the detector housing and screw down.

16.

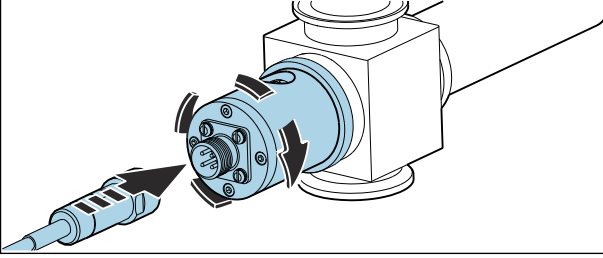

Re-attach the detector to the flow assembly, screw on sensor cable.

Then recalibrate/readjust the measuring system.

In addition, reset the counter for filter replacement in the case of the CM44P: **CAL/Photometer/Filter change/Reset**

8.6 Replacing the sensor window and seal



Operating Instructions for Flowcell OUA260, BA01600C

Operating Instructions for CUA261, BA01652C



If you have mounted the sensor in a VARIVENT flow assembly using the CUA261 adapter, refer to the Operating Instructions of the adapter for information on removal and on replacing the optical windows.

Removing optical windows and seals

Always replace windows with windows of the same type in order to maintain the path length.

The following applies for OUA260:

The flow assembly must be removed from the process line in order to replace the windows and seals.

1. In the case of OUA260 only:
Stop the flow in the process pipe and remove the assembly from the **dry** process line.
2. Remove the lamp and detector housing from the assembly.

The following description applies for both sides, i.e. the detector side and the lamp side. Always change O-rings or optical windows ¹⁾ on both sides.

3.

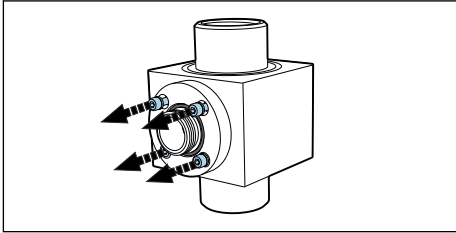

Remove the 4 Allen screws (1/8" or 3 mm) from the window ring. Make sure to loosen the screws evenly and alternately around the window ring.

4.

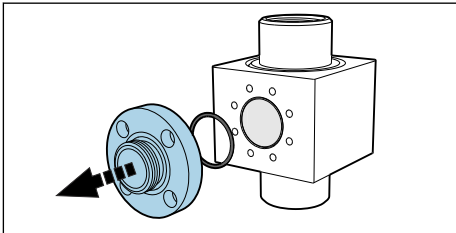

Remove the window ring .

5.

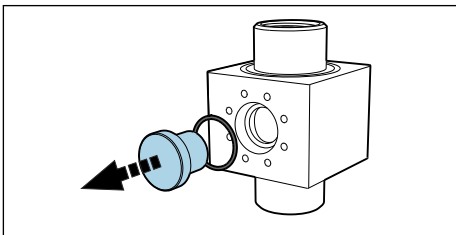

Gently push the optical window out of the assembly. If the window jams, apply some acetone around the window seal (O-ring) and wait a few minutes for it to take effect. This should help release the window. **The seal cannot be reused afterwards!**

Checking or replacing optical windows and seals

1. Check the window area for residue or fouling. Clean if necessary.
2. Check the optical windows for signs of chipping or abrasion.
 - ↳ Replace the windows if signs of chipping/abrasion are found.
3. Dispose of all the O-rings and replace them with new O-rings from the relevant maintenance kit.

1) Optical windows only need to be replaced if they are damaged.

4. Mount the optical window and then the window ring, along with the new seals, on the assembly. Make sure to tighten the screws of the window ring uniformly in a diagonally opposite sequence. In this way, you ensure that the ring is seated correctly.
5. If the optical windows and the window rings are not identical, make sure the lamp is on the right side. The lamp should be on the side with the "shorter" window length. Then mount the lamp and detector on the assembly.

 If you have changed the path length by installing other optical windows, you then have to configure the measuring system appropriately.

In any case, you must always perform an adjustment with liquids after disassembling and assembling the windows.

9 Repair

9.1 General notes

The repair and conversion concept provides for the following:

- The product has a modular design
- Spare parts are grouped into kits which include the associated kit instructions
- Only use original spare parts from the manufacturer
- Repairs are carried out by the manufacturer's Service Department or by trained users
- Certified devices can only be converted to other certified device versions by the manufacturer's Service Department or at the factory
- Observe applicable standards, national regulations, Ex documentation (XA) and certificates

1. Carry out the repair according to the kit instructions.
2. Document the repair and conversion and enter, or have entered, in the Life Cycle Management tool (W@M).

9.2 Spare parts

Device spare parts that are currently available for delivery can be found on the website:

<https://portal.endress.com/webapp/SparePartFinder>

- ▶ Quote the serial number of the device when ordering spare parts.

9.3 Return

The product must be returned if repairs or a factory calibration are required, or if the wrong product was ordered or delivered. As an ISO-certified company and also due to legal regulations, Endress+Hauser is obliged to follow certain procedures when handling any returned products that have been in contact with medium.

To ensure the swift, safe and professional return of the device:

- ▶ Check the website www.endress.com/support/return-material for information on the procedure and general conditions.

9.4 Disposal



If required by the Directive 2012/19/EU on waste electrical and electronic equipment (WEEE), the product is marked with the depicted symbol in order to minimize the disposal of WEEE as unsorted municipal waste. Do not dispose of products bearing this marking as unsorted municipal waste. Instead, return them to the manufacturer for disposal under the applicable conditions.

Dispose of the mercury lamp correctly

- ▶ Dispose of the mercury lamp according to local guidelines.

10 Accessories

The following are the most important accessories available at the time this documentation was issued.

Listed accessories are technically compatible with the product in the instructions.

1. Application-specific restrictions of the product combination are possible.
Ensure conformity of the measuring point to the application. This is the responsibility of the operator of the measuring point.
2. Pay attention to the information in the instructions for all products, particularly the technical data.
3. For accessories not listed here, please contact your Service or Sales Center.

10.1 Flow assembly

OUA260

- Flow assembly for hygienic sensors
- For sensor installation in pipes
- Numerous materials, process connections and path length versions available
- Product Configurator on the product page: www.endress.com/oua260



Technical Information TI00418C

CUA261

- VARIVENT adapter for installation in VARINLINE housing
- Hygienic process connection, suitable for cleaning in the process (CIP) and sterilization in the process (SIP)
- Numerous window materials and path length versions available
- Product Configurator on the product page: www.endress.com/cua261



Operating Instructions BA01652C

10.2 Cables

CUK80 cable set

- Pre-terminated and labeled cables for connecting analog photometer sensors
- Order as per product structure

10.3 Calibration

Kit OUSA46 EasyCal retrofit kit

- Patented system traceable to NIST for the calibration of UV absorption sensors
- Order numbers:
 - 254/280 nm: 71382018
 - 280/295 nm: 71382019
 - 280/313 nm: 71382020

Reference rod

Order number: 71108543

11 Technical data

11.1 Input

11.1.1 Measured variable

UV-absorption

11.1.2 Measuring range

- 0 to 2.5 AU
- Max. 50 OD (depending on the optical path length)

11.1.3 Wavelength

Discrete wavelength combination at 254/280, 280/295, 280/302 or 280/313 nm

11.2 Environment

11.2.1 Ambient temperature

Non-hazardous area versions

0 to 55 °C (32 to 131 °F)

Hazardous area versions

2 to 40 °C (36 to 104 °F)

11.2.2 Storage temperature

-10 to +70 °C (+10 to +160 °F)

11.2.3 Humidity

5 to 95 %

11.2.4 Degree of protection

IP65 and NEMA 4

11.3 Process

11.3.1 Process temperature

0 to 90 °C (32 to 194 °F) continuous

Max. 130 °C (266 °F) for 2 hours

11.3.2 Process pressure

Max. 100 bar (1450 psi) absolute, depending on the material, pipe size and process connection of the flow assembly

11.4 Mechanical construction

11.4.1 Dimensions

→  10

11.4.2 Weight

Sensor

UV lamp	0.58 kg (1.28 lbs)
UV lamp with wire-braided cable (1.2 m (4 ft)) and junction box (sensor for hazardous area)	3.2 kg (6.66 lbs)
Easycal detector	0.53 kg (1.17 lbs)
Standard detector	0.78 kg (1.71 lbs)

Assembly OUA260



Technical Information OUA260, TI00418C

Assembly CUA261



Operating Instructions CUA261, BA01652C

11.4.3 Materials

Sensor housing

Stainless steel 316

Assembly OUA260



Technical Information OUA260, TI00418C

Assembly CUA261



Operating Instructions CUA261, BA01652C

Cable connector ends

Nickel-plated brass

11.4.4 Light source

Low-pressure mercury lamp

Lamp operating life: typically 3000 h



The lamp will not operate at full capacity until a warm-up period of 30 minutes has elapsed.

11.4.5 Detector

UV silicon detector, hermetically sealed

11.4.6 Filter

Multilayer interference filter, designed for extreme UV conditions

Index

A

Accessories 31

C

Check

 Connection 15

 Mounting 12

Connection

 Check 15

 Measuring instrument 13

D

Device description 6

Dimensions 10

Disposal 31

E

EasyCal 17

Ensuring the degree of protection 14

F

Function check 16

I

Identifying the product 7

Incoming acceptance 7

Intended use 4

L

Lamp voltage 14

M

Maintenance schedule 19

Measured variable 32

Measuring principle 6

Measuring range 32

Measuring system 8

Mounting

 Check 12

Mounting angle 11

Mounting requirements 8

Mounting the sensor 11

N

Nameplate 7

O

Operational safety 4

P

Power supply

 Connecting the measuring instrument . . . 13

Product safety 5

R

Reference rod 17

Replacing

 Mercury lamp 19

 Sensor window and seal 28

Requirements for the personnel 4

Return 30

S

Safety

 Operational 4

 Product 5

 Workplace safety 4

Safety information 3

Safety instructions 4

Scope of delivery 8

Symbols 3

T

Technical personnel 4

U

Use

 Intended 4

W

Wavelength 32

Workplace safety 4



71680007

www.addresses.endress.com
