

# Operating Instructions TOC Analyzer CA78

Determination of trace levels of total organic carbon (TOC)

Powerful compact device







## Table of contents









<b>1</b>	<b>About this document</b> .....	<b>4</b>	<b>10</b>	<b>Diagnostics and troubleshooting</b> ...	<b>34</b>
1.1	Safety information .....	4	10.1	Firmware history .....	34
1.2	Symbols .....	4	<b>11</b>	<b>Maintenance</b> .....	<b>35</b>
1.3	Symbols on the device .....	4	11.1	Maintenance schedule .....	35
1.4	Documentation .....	4	11.2	Maintenance work .....	35
<b>2</b>	<b>Basic safety instructions</b> .....	<b>5</b>	11.3	Decommissioning .....	40
2.1	Requirements for the personnel .....	5	<b>12</b>	<b>Repair</b> .....	<b>41</b>
2.2	Intended use .....	5	12.1	Spare parts .....	41
2.3	Workplace safety .....	5	12.2	Return .....	41
2.4	Operational safety .....	5	12.3	Disposal .....	41
2.5	Product safety .....	6	<b>13</b>	<b>Accessories</b> .....	<b>42</b>
<b>3</b>	<b>Incoming acceptance and product identification</b> .....	<b>7</b>	<b>14</b>	<b>Technical data</b> .....	<b>43</b>
3.1	Incoming acceptance .....	7	14.1	Input .....	43
3.2	Product identification .....	7	14.2	Output .....	43
3.3	Scope of delivery .....	8	14.3	Current outputs, active .....	43
<b>4</b>	<b>Product description</b> .....	<b>9</b>	14.4	Energy supply .....	44
4.1	Product design .....	9	14.5	Performance characteristics .....	44
4.2	Process diagram .....	10	14.6	Environment .....	44
4.3	Socket assignment .....	10	14.7	Process .....	45
<b>5</b>	<b>Installation</b> .....	<b>12</b>	14.8	Mechanical construction .....	45
5.1	Installation requirements .....	12	<b>Index</b> .....	<b>47</b>	
5.2	Mounting the analyzer .....	13			
5.3	Post-installation check .....	14			
<b>6</b>	<b>Electrical connection</b> .....	<b>16</b>			
6.1	Connecting instructions .....	16			
6.2	Connecting the analyzer .....	16			
6.3	Ensuring the degree of protection .....	16			
6.4	Post-connection check .....	16			
<b>7</b>	<b>Operation options</b> .....	<b>17</b>			
7.1	Overview of operation options .....	17			
7.2	Structure and function of the operating menu .....	17			
7.3	Access to the operating menu via the local display .....	18			
<b>8</b>	<b>Commissioning</b> .....	<b>19</b>			
8.1	Post-installation and function check .....	19			
8.2	Login procedure .....	19			
8.3	Configuring the measuring instrument .....	19			
<b>9</b>	<b>Operation</b> .....	<b>33</b>			

# 1 About this document

## 1.1 Safety information

Structure of information	Meaning
 <b>DANGER</b> <b>Causes (/consequences)</b> If necessary, Consequences of non-compliance (if applicable) ▶ Corrective action	This symbol alerts you to a dangerous situation. Failure to avoid the dangerous situation <b>will</b> result in a fatal or serious injury.
 <b>WARNING</b> <b>Causes (/consequences)</b> If necessary, Consequences of non-compliance (if applicable) ▶ Corrective action	This symbol alerts you to a dangerous situation. Failure to avoid the dangerous situation <b>can</b> result in a fatal or serious injury.
 <b>CAUTION</b> <b>Causes (/consequences)</b> If necessary, Consequences of non-compliance (if applicable) ▶ Corrective action	This symbol alerts you to a dangerous situation. Failure to avoid this situation can result in minor or more serious injuries.
<b>NOTICE</b> <b>Cause/situation</b> If necessary, Consequences of non-compliance (if applicable) ▶ Action/note	This symbol alerts you to situations which may result in damage to property.

## 1.2 Symbols

-  Additional information, tips
-  Permitted
-  Recommended
-  Not permitted or not recommended
-  Reference to device documentation
-  Reference to page
-  Reference to graphic
-  Result of an individual step

## 1.3 Symbols on the device

-  Reference to device documentation

## 1.4 Documentation

The following manuals, which complement these Operating Instructions, can be found on the product pages on the Internet:

-  Technical Information TOC Analyzer CA78, TI01622C

## 2 Basic safety instructions

### 2.1 Requirements for the personnel

- Installation, commissioning, operation and maintenance of the measuring system may be carried out only by specially trained technical personnel.
- The technical personnel must be authorized by the plant operator to carry out the specified activities.
- The electrical connection may be performed only by an electrical technician.
- The technical personnel must have read and understood these Operating Instructions and must follow the instructions contained therein.
- Faults at the measuring point may only be rectified by authorized and specially trained personnel.

 Repairs not described in the Operating Instructions provided must be carried out only directly at the manufacturer's site or by the service organization.

### 2.2 Intended use

The analyzer is designed to determine the total organic carbon in ultrapure water applications that meet the following conditions:

- Conductivity < 10  $\mu\text{S}/\text{cm}$
- pH range: neutral

Any use other than that intended puts the safety of people and the measuring system at risk. Therefore, any other use is not permitted.

The manufacturer is not liable for harm caused by improper or unintended use.

### 2.3 Workplace safety

The operator is responsible for ensuring compliance with the following safety regulations:

- Installation guidelines
- Local standards and regulations

#### Electromagnetic compatibility

- The product has been tested for electromagnetic compatibility in accordance with the applicable international standards for industrial applications.
- The electromagnetic compatibility indicated applies only to a product that has been connected in accordance with these Operating Instructions.

### 2.4 Operational safety

#### Before commissioning the entire measuring point:

1. Verify that all connections are correct.
2. Ensure that electrical cables and hose connections are undamaged.

#### Procedure for damaged products:

1. Do not operate damaged products, and protect them against unintentional operation.
2. Label damaged products as defective.

#### During operation:

- ▶ If faults cannot be rectified, take products out of service and protect them against unintentional operation.

## **2.5 Product safety**

### **2.5.1 State of the art**

The product is designed to meet state-of-the-art safety requirements, has been tested, and left the factory in a condition in which it is safe to operate. The relevant regulations and international standards have been observed.

### **2.5.2 IT security**

We only provide a warranty if the device is installed and used as described in the Operating Instructions . The device is equipped with security mechanisms to protect it against any inadvertent changes to the device settings.

IT security measures in line with operators' security standards and designed to provide additional protection for the device and device data transfer must be implemented by the operators themselves.

## 3 Incoming acceptance and product identification

### 3.1 Incoming acceptance

1. Verify that the packaging is undamaged.
  - ↳ Notify the supplier of any damage to the packaging.  
Keep the damaged packaging until the issue has been resolved.
2. Verify that the contents are undamaged.
  - ↳ Notify the supplier of any damage to the delivery contents.  
Keep the damaged goods until the issue has been resolved.
3. Check that the delivery is complete and nothing is missing.
  - ↳ Compare the shipping documents with your order.
4. Pack the product for storage and transportation in such a way that it is protected against impact and moisture.
  - ↳ The original packaging offers the best protection.  
Make sure to comply with the permitted ambient conditions.

If you have any questions, please contact your supplier or your local Sales Center.

### 3.2 Product identification

#### 3.2.1 Nameplate

The nameplate provides you with the following information on your device:

- Manufacturer identification
  - Order code (device version)
  - Serial number
  - Extended order code
  - Power supply
  - Degree of protection
  - (Permitted) ambient conditions
- ▶ Compare the information on the nameplate with the order.

#### 3.2.2 Identifying the product

##### Product page

[www.endress.com/ca78](http://www.endress.com/ca78)

##### Interpreting the order code

The order code and serial number of your product can be found in the following locations:

- On the nameplate
- In the delivery papers

##### Obtaining information on the product

1. Go to [www.endress.com](http://www.endress.com).
2. Page search (magnifying glass symbol): Enter valid serial number.
3. Search (magnifying glass).
  - ↳ The product structure is displayed in a popup window.

4. Click the product overview.
  - ↳ A new window opens. Here you fill information pertaining to your device, including the product documentation.



### 3.2.3 Manufacturer's address

Endress+Hauser Conducta GmbH+Co. KG  
Dieselstraße 24  
70839 Gerlingen  
Germany

## 3.3 Scope of delivery

The scope of delivery comprises:

- 1 analyzer with the configuration ordered
  - 1 installation kit
  - 1 certificate of calibration
  - 1 x Operating Instructions
- ▶ If you have any queries:  
Please contact your supplier or local sales center.



## 4 Product description

### 4.1 Product design

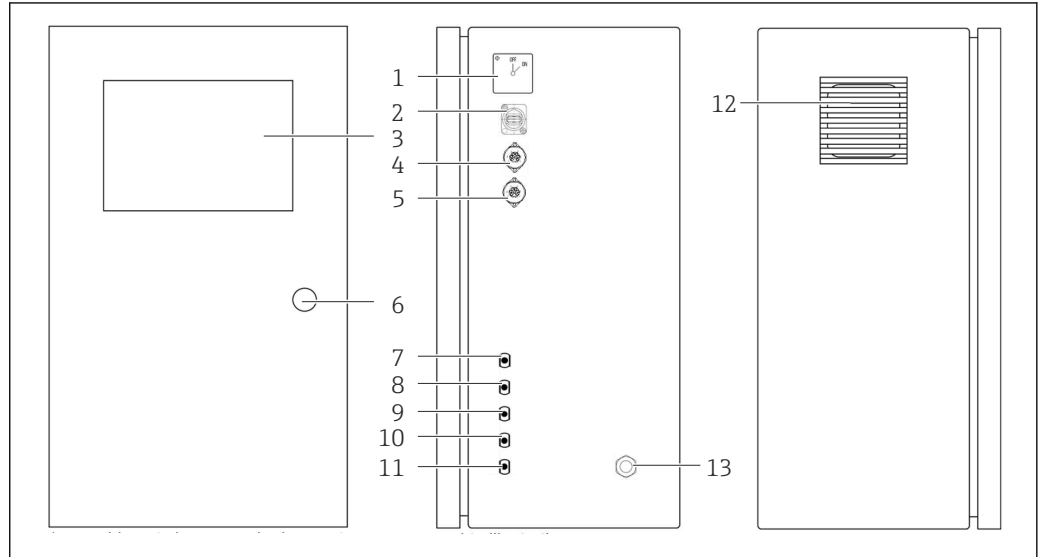

A0046933

#### 1 Product design

- 1 Main switch
- 2 USB port
- 3 Display
- 4 Analog output 1
- 5 Analog output 2
- 6 Housing lock
- 7 Fluid inlet, sample, UNF ¼ - 28 (order option)
- 8 Fluid inlet 1, UNF ¼ - 28
- 9 Fluid inlet 2, UNF ¼ - 28 (order option)
- 10 Fluid inlet 3, UNF ¼ - 28 (order option)
- 11 Fluid outlet, waste, UNF ¼ - 28
- 12 Fan housing with filter mat
- 13 Cable gland for power supply

## 4.2 Process diagram

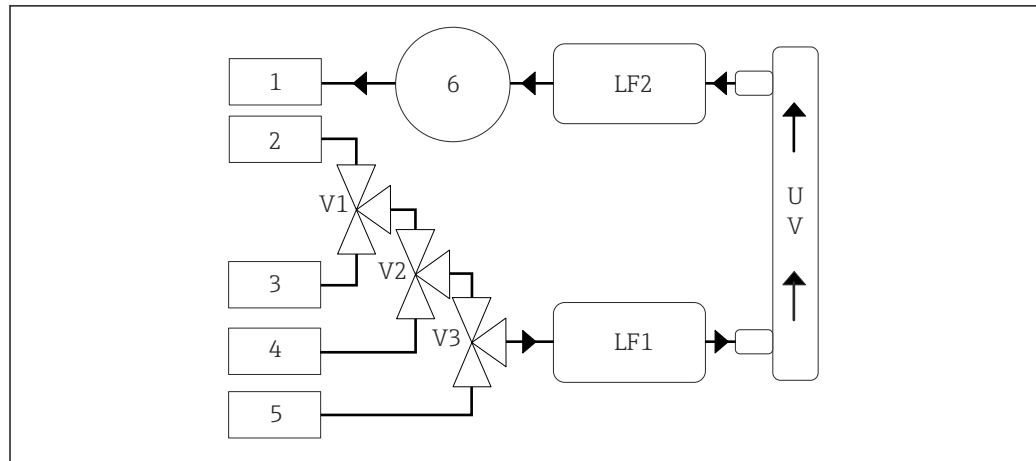

A0046935

2 Process diagram

- 1 Waste
- 2 Sample
- 3 Input 1
- 4 Input 2
- 5 Input 3
- 6 Pump
- V1 - Valve 1, valve 2 (order option) and valve 3 (order option)
- V3
- LF1 - Conductivity and temperature sensors
- LF2
- UV UV lamp (12 VDC)

## 4.3 Socket assignment

### 4.3.1 Socket assignment (system with a connection socket)

Socket	Pin	Description
<p>A0046897</p>	1: 4 (0) - 20 mA (GND) 2: 4 (0) - 20 mA (+)	TOC (0 to set limit)
	3: 4 (0) - 20 mA (GND) 4: 4 (0) - 20 mA (+)	Δ conductivity (0 to set limit)
	5: Relay 6: Relay	Group error message or limit value overshoot depending on the selected option

**Pin 1/2:** Provides an analog signal between 4 and 20 mA for the TOC measured value between 0 and the limit (to be configured in the **Settings** menu, **Options 1** tab).

**Pin 3/4:** Provides an analog signal between 4 and 20 mA for the Δ conductivity value between 0 and the limit in  $\mu\text{S}/\text{cm}$  (to be configured in the **Settings** menu, **Service 1** tab <sup>1)</sup>).

**Pin 5/6:** Acts as an NO contact if the configured TOC or conductivity limit value is exceeded in the "analog output" option, or as an NC contact in the option with a group error message in the event of a power failure, a reaction of the leak, lamp or pressure sensor and if one of the two conductivity sensors is over range.

1) service password required

The measured value is updated every minute. During a calibration, the last value is displayed until a new measurement is started.

### 4.3.2 Socket assignment (system with two connection sockets)

#### Output 1

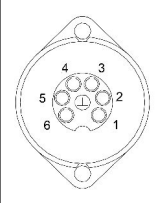
Socket	Pin	Description
 A0046897	1: 4 (0) - 20 mA (GND) 2: 4 (0) - 20 mA (+)	TOC 1 (0 to set limit)
	3: 4 (0) - 20 mA (GND) 4: 4 (0) - 20 mA (+)	$\Delta$ conductivity (0 to set limit)
	5: Relay 6: Relay	Group error message or limit value overshoot depending on the selected option

**Pin 1/2:** Provides an analog signal between 4 and 20 mA for the TOC measured value at the SAMPLE input between 0 and the limit (to be configured in the **Settings** menu, **Options 1** tab).

**Pin 3/4:** Provides an analog signal between 4 and 20 mA for the  $\Delta$  conductivity value between 0 and the limit in  $\mu\text{S}/\text{cm}$  (to be configured in the **Settings** menu, **Service 1** tab <sup>2)</sup>).

**Pin 5/6:** Acts as an NO contact if the configured TOC or conductivity limit value is exceeded in the "analog output" option, or as an NC contact in the option with a group error message in the event of a power failure, a reaction of the leak, lamp or pressure sensor and if one of the two conductivity sensors is over range.

#### Output 2

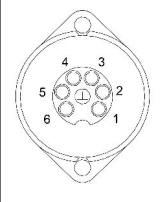
Socket	Pin	Description
 A0046897	1: 4 (0) - 20 mA (GND) 2: 4 (0) - 20 mA (+)	TOC 2 (0 to set limit)
	3: 4 (0) - 20 mA (GND) 4: 4 (0) - 20 mA (+)	TOC 3 (0 to set limit)
	5: Controller (GND) 6: Controller (+)	Controller input / trigger for 24 V DC

**Pin 1/2:** Provides an analog signal between 4 and 20 mA for the TOC measured value at INPUT 2 between 0 and the limit (to be configured in the **Settings** menu, **Options 1** tab).

**Pin 3/4:** Provides an analog signal between 4 and 20 mA for the TOC measured value at INPUT 3 between 0 and the limit (to be configured in the **Settings** menu, **Options 1** tab).

**Pin 5/6:** External controller input / trigger, measurement is active when the voltage is applied and stops if the voltage is 0 V.

The measured value is updated every minute. During a calibration, the last value is displayed until a new measurement is started.

2) service password required

## 5 Installation

### 5.1 Installation requirements

#### 5.1.1 Dimensions

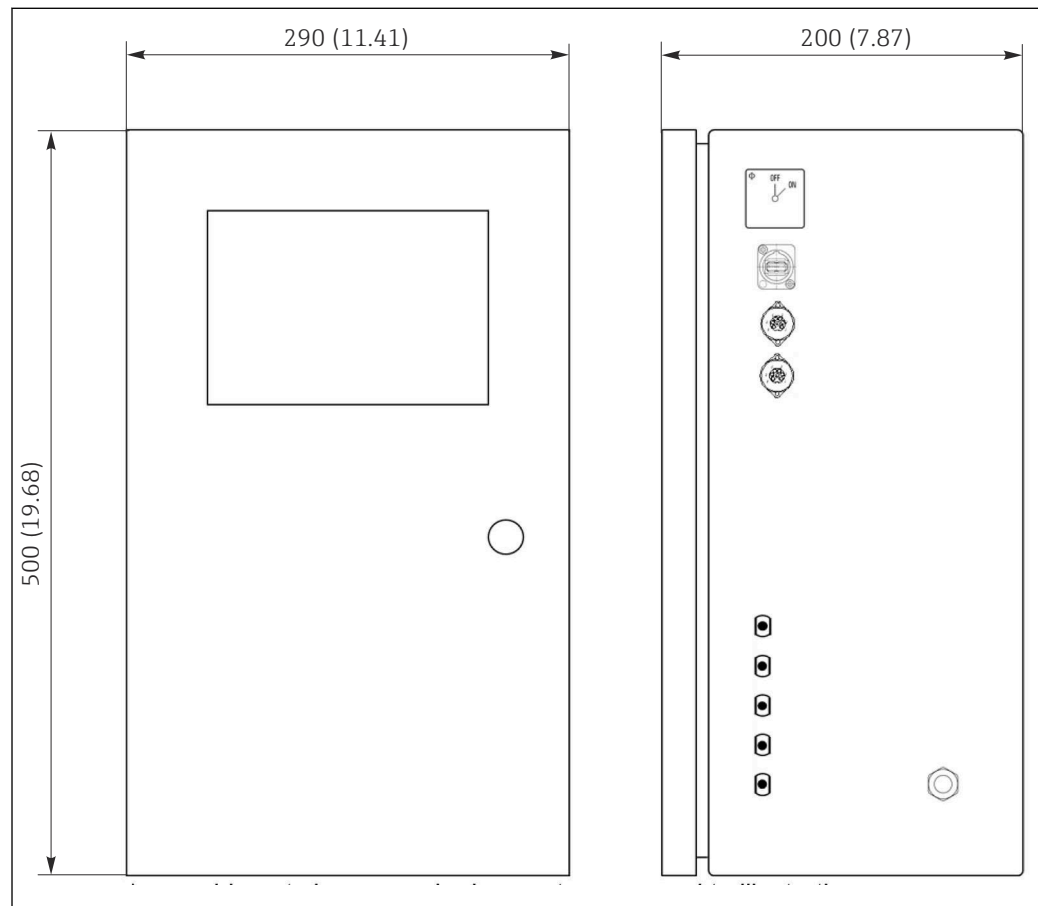

3 Dimensions in mm (in)

#### 5.1.2 Mounting options

The analyzer is designed for bench-top mounting and wall mounting.

**i** The following graphic shows the location of the blind rivet nuts on the back of the housing. They can be used to secure a mounting frame. The mounting frame for wall mounting is not included in the delivery.

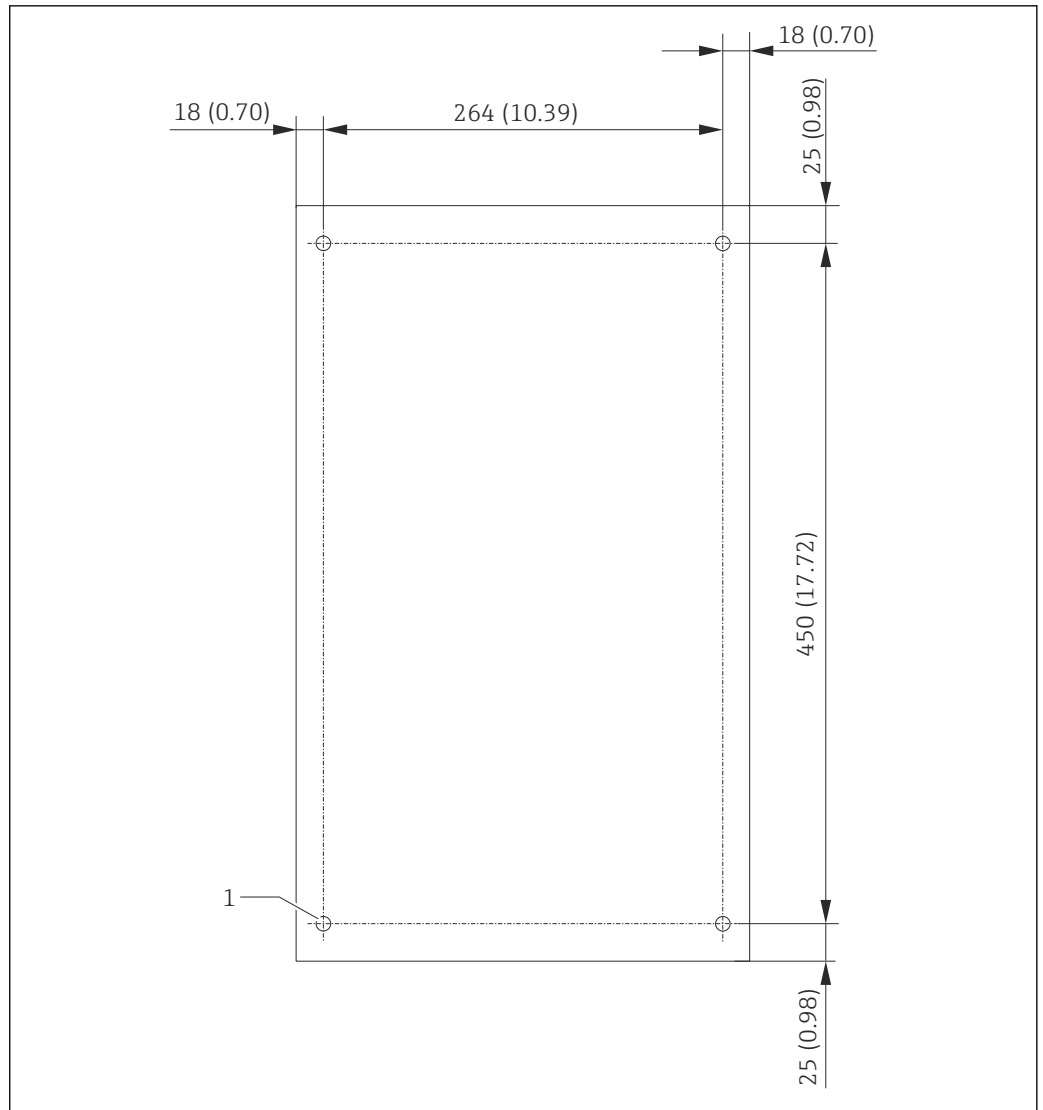

4 Rear of the housing

1 Blind rivet nut

## 5.2 Mounting the analyzer

### **⚠ WARNING**

**The device is live!**

Risk of electric shock!

- ▶ Do not connect the analyzer to the electricity supply before the installation work is completed and the media are connected.
- ▶ Follow the instructions in the "Electrical connection" section.

### 5.2.1 Mounting sequence

#### Bench-top mounting

1. Place the analyzer on an even, vibration-free surface.
2. Open the front door of the housing and check the interior structure for visible signs of damage.
3. Check all the built-in fluid connections. The hoses must not be bent or damaged.
4. Check all the fluid couplings to ensure they are fitted securely (tighten by hand).

5. After the visual inspections, it is time to mount the sample feed lines and the waste line of the TOC system. It is important to keep the lines as short as possible and, when shortening, to cut them straight at a right angle with a hose cutter.

#### Mounting on a wall

1. Open the front door of the housing and check the interior structure for visible signs of damage.
2. Check all the built-in fluid connections. The hoses must not be bent or damaged.
3. Check all the fluid couplings to ensure they are fitted securely (tighten by hand).
4. After the visual inspections, it is time to mount the sample feed lines and the waste line of the TOC system. It is important to keep the lines as short as possible and, when shortening, to cut them straight at a right angle with a hose cutter.
5. Mount the housing on the mounting frame.
6. Mount the customer-specific mounting frame on the wall.

#### Electrical connection

1. Connect the signal outputs →  10.
2. Plug the mains plug into the socket (240 V, 50/60 Hz or optionally 100 V, 50/60 Hz).

### 5.2.2 Connecting the media

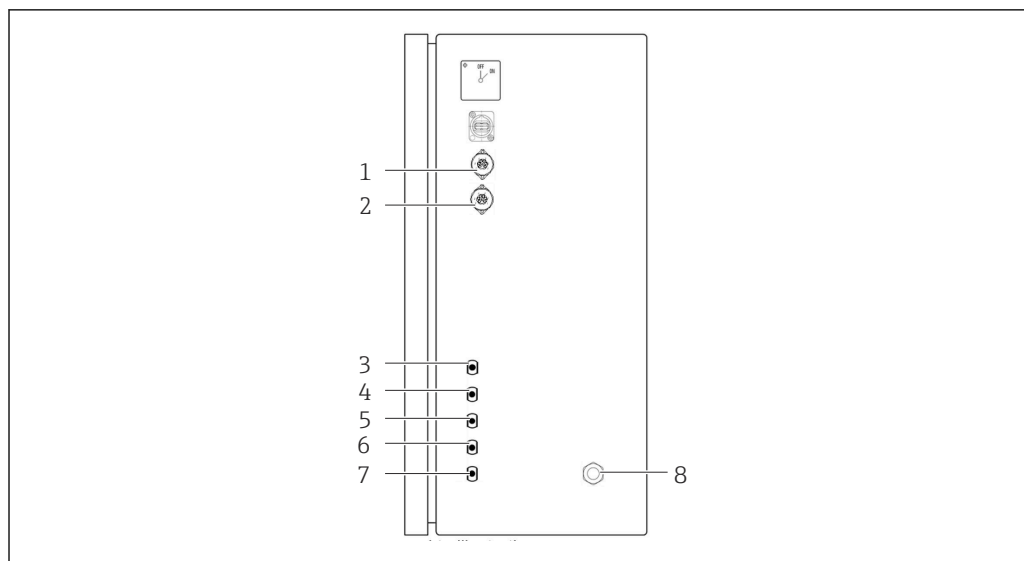

A0047048

 5 Analyzer, right side panel

1 Analog output 1	4 Input 1	7 Waste
2 Analog output 2	5 Input 2 (order option)	8 Power connection
3 Sample	6 Input 3 (order option)	

#### Analyzer sample outlet

The sample is drained (waste sample) via a hose.

- ▶ Route the hose in such a way that backpressure cannot form.

### 5.3 Post-installation check

1. Check whether all the connections are secure and do not have any leaks.

2. Inspect all the hoses for any damage.
  - ↳ Replace damaged hoses.

## 6 Electrical connection

### 6.1 Connecting instructions

#### WARNING

##### The device is live!

Risk of electric shock! The line filter, the overvoltage module and the main switch are still connected to the power supply even when the main switch is switched off!

- ▶ Disconnect the device from the power supply (unplug the mains plug).
- ▶ Before connecting, ensure that the mains voltage matches the voltage indicated on the nameplate.
- ▶ Ensure that the analyzer is sufficiently grounded via the mains connection.
- ▶ Before establishing the electrical connection, verify that the pre-installed power cable meets the local national electrical safety specifications.

### 6.2 Connecting the analyzer

- ▶ Plug the mains plug into the socket (240 V, 50/60 Hz or optionally 100 V, 50/60 Hz).

### 6.3 Ensuring the degree of protection

Only the mechanical and electrical connections which are described in these instructions, and which are necessary for the required intended use, may be established on the device delivered.

- ▶ Exercise care when carrying out the work.

Otherwise, the individual types of protection (Ingress Protection (IP), electrical safety, EMC interference immunity) agreed for this product can no longer be guaranteed due, for example, to covers being left off or cable (ends) that are loose or insufficiently secured.

### 6.4 Post-connection check

Carry out the following checks once you have made the electrical connection:

Device condition and specifications	Notes
Are the cables free from damage on the outside?	Visual inspection

Electrical connection	Notes
Does the supply voltage of the connected transmitter match the data on the nameplate?	240 V AC 50/60 Hz 100 V AC 50/60 Hz
Are the current outputs shielded and connected?	
Are the connected cables provided with strain relief?	
Are the cable types properly isolated from one another?	Route the power cable and signal cables separately from one another over the entire route. Separate cable ducts are ideal.
Is the cable run correct, without loops and cross-overs?	
Are the power cable and signal cables connected correctly and in accordance with the wiring diagram?	



## 7 Operation options

### 7.1 Overview of operation options

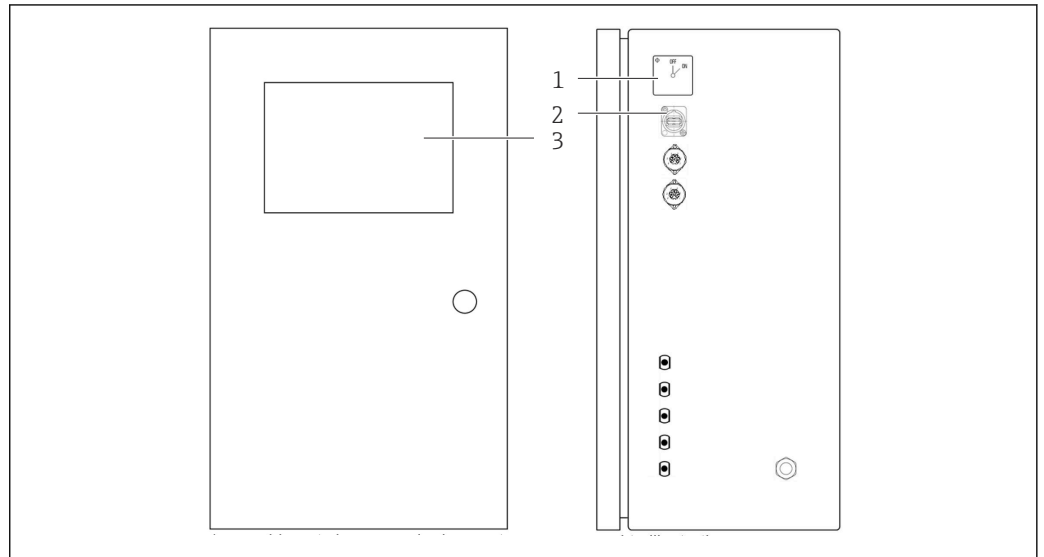

A0047049

#### 6 Operating elements

- 1 Main switch
- 2 USB port
- 3 Touch screen monitor

### 7.2 Structure and function of the operating menu

The analyzer has the following menus:

- Measure online
- Viewer (History)
- Qualification (Calibration)
- System (Service)
- Settings (Advanced settings and service)

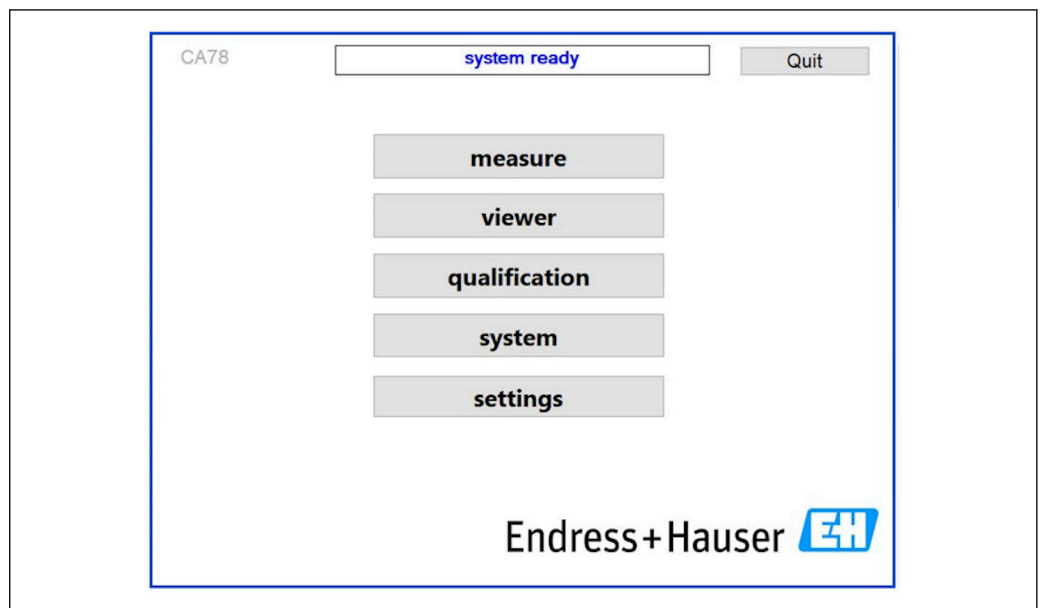

A0046941

### 7.3 Access to the operating menu via the local display

Key	Function
Measure	<ul style="list-style-type: none"><li>▶ Press the key.<ul style="list-style-type: none"><li>↳ TOC measurement is started.</li></ul></li></ul>
Viewer	<ul style="list-style-type: none"><li>▶ Press the key.<ul style="list-style-type: none"><li>↳ The <b>Viewer</b> menu is opened. All TOC measured values can be viewed via this menu.</li></ul></li></ul>
Qualification	<ul style="list-style-type: none"><li>▶ Press the key.<ul style="list-style-type: none"><li>↳ The <b>Qualification</b> menu is opened. Functions can be selected via this menu.</li></ul></li></ul>
System	<ul style="list-style-type: none"><li>▶ Press the key.<ul style="list-style-type: none"><li>↳ The <b>System</b> menu is opened. Function checks on the most important components can be performed in this menu.</li></ul></li></ul>
Settings	<ul style="list-style-type: none"><li>▶ Press the key.<ul style="list-style-type: none"><li>↳ The <b>Settings</b> menu is opened. Device parameters can be configured in this menu.</li></ul></li></ul>

## 8 Commissioning

### 8.1 Post-installation and function check

Incorrect or improperly connected hose connections cause liquid to leak and can cause damage!

- ▶ Check all connections and ensure they have been established correctly.
- ▶ In particular, check all hose connections to ensure they are secure and liquid cannot escape.

Incorrect power supply will damage the device!

- ▶ Ensure that the supply voltage matches the voltage indicated on the nameplate.

### 8.2 Login procedure

1. Enter the four-digit ID (2199).
2. Press OK in the Login window.
3. Enter the four-digit PIN (9708).
4. Press OK in the Login window.

 If you press the Enter key of a connected keyboard, or use the mouse to click on the next line, these actions are not performed.

### 8.3 Configuring the measuring instrument

#### 8.3.1 Performing the measurement

 Before initial commissioning, a rinsing process (a measurement) must be performed for at least 30 minutes. In the event of larger impurities and contamination, rinsing (measurement) must continue until the same values are consistently displayed.

1. Press the **Measure** key in the main menu.
  - ↳ A pop-up window opens.
2. Press the **Yes** key.
  - ↳ The program starts by rinsing the system in order to prepare for the TOC measurement.
3. Change the time intervals:  
Select the time intervals by pressing the appropriate key below the chart.
4. Display the history:  
Press the **Viewer** key in the main menu.
  - ↳ The **Viewer** menu is opened and the history is displayed →  22. This does not interrupt the measurement.
5. Interrupt the measurement:  
Exit the **Measure** menu.

Once the rinsing process is finished, the measurement is started automatically. The TOC, conductivity and temperature values are shown on the display. The measured values are shown in the chart on the right-hand side. If the TOC or conductivity value exceeds the configured limit value, the value is displayed in red. In addition, a warning is output via an analog output (optional). The limit can be shown as a red line in the chart.

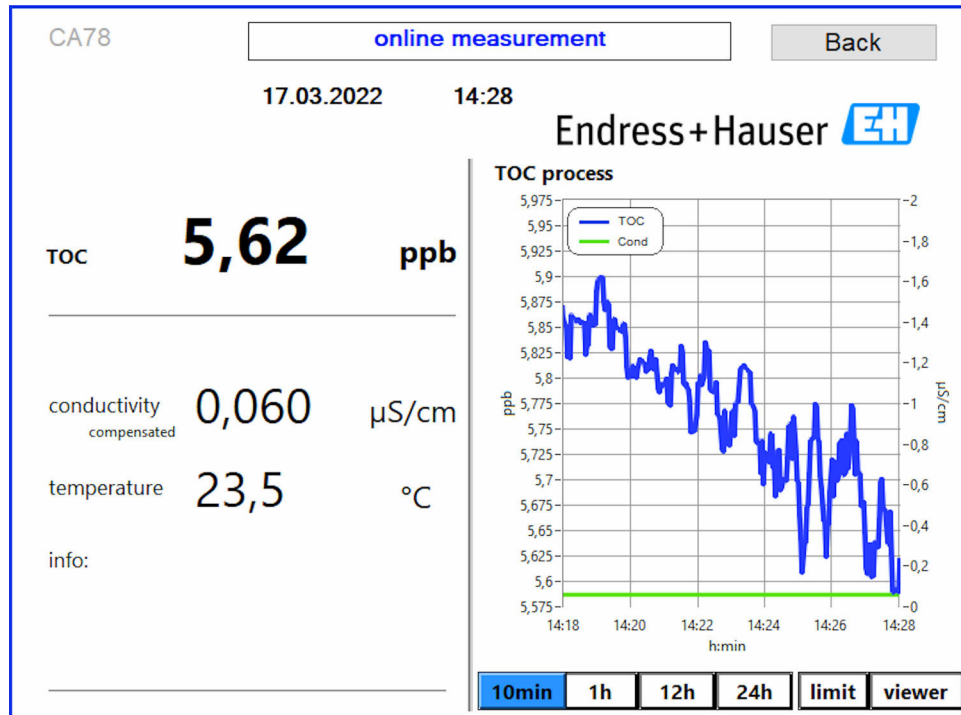

A0050167

**Warnings**

If the TOC and/or conductivity is above the configured limit, the value is displayed in red digits. In addition, a warning is output via a digital output (optional). The limit can be shown as a red line in the chart.

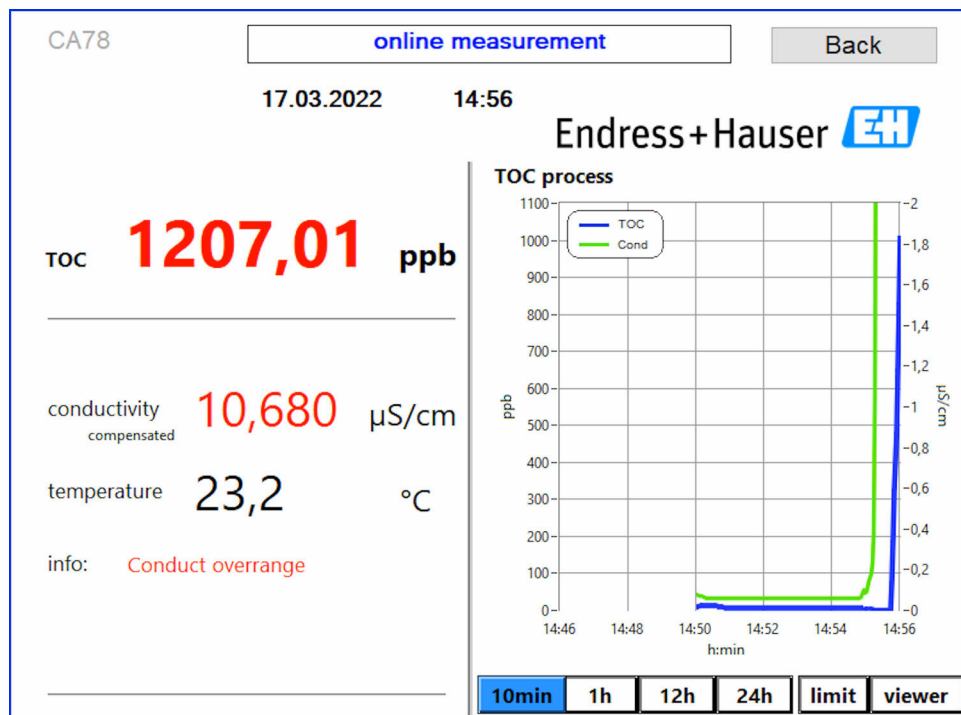

A0050168

7 Measurement over range limit

**Leak in the system**

If there is a leak in the system, the analyzer stops the measurement automatically and closes valve 1. Once the leak has been found and eliminated, the analyzer starts measuring again (only if the **Continue after error** option is enabled in the **Settings** menu, **Options 2** tab → ☰ 27. The leak sensor in the system must be dried thoroughly beforehand. The leak sensor is located on the base of the device on the right-hand side.

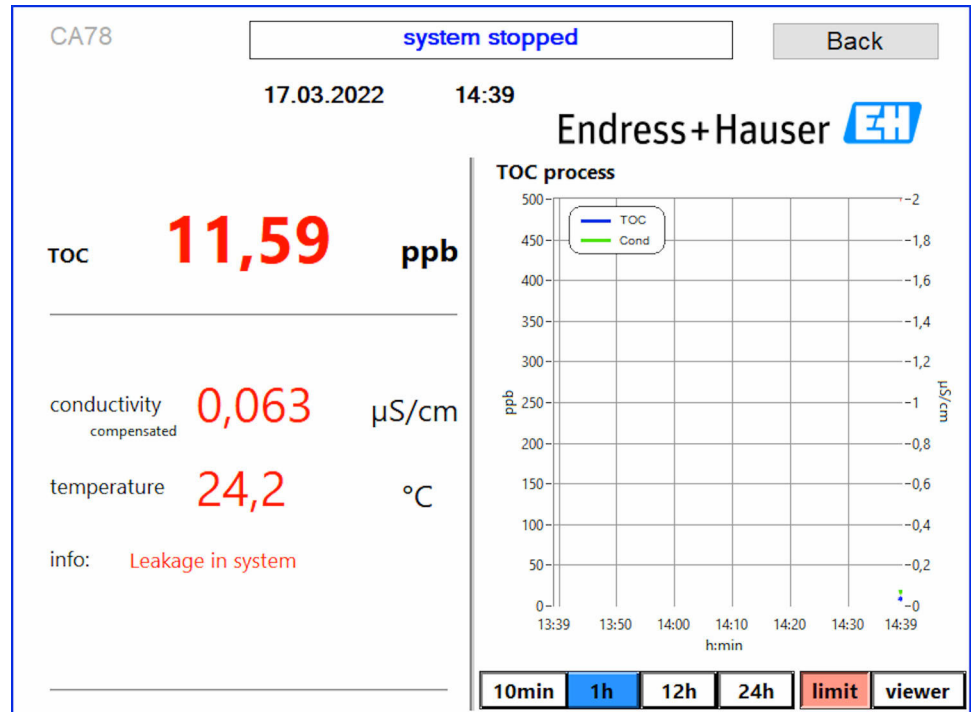

A0050170

☰ 8 *Leak in the system*

### UV intensity too low

If the intensity of the UV lamp is too low or if the UV lamp is defective, the analyzer stops the measurement automatically and the **UV lamp broken** message is displayed. In this case, a new UV reactor is needed.

#### **⚠ WARNING**

#### **Radiation source with short-wave UV radiation!**

Improper handling can cause damage to eyes and skin!

- ▶ Before working on the reactor, always take the device out of service and disconnect it from the power supply!
- ▶ Always replace the reactor as a complete assembly!
- ▶ Take damaged reactors out of service!
- ▶ Never open the reactor to replace individual components!
- ▶ Ensure the insulation at the reactor ends is intact (undamaged heat shrink tubes)!

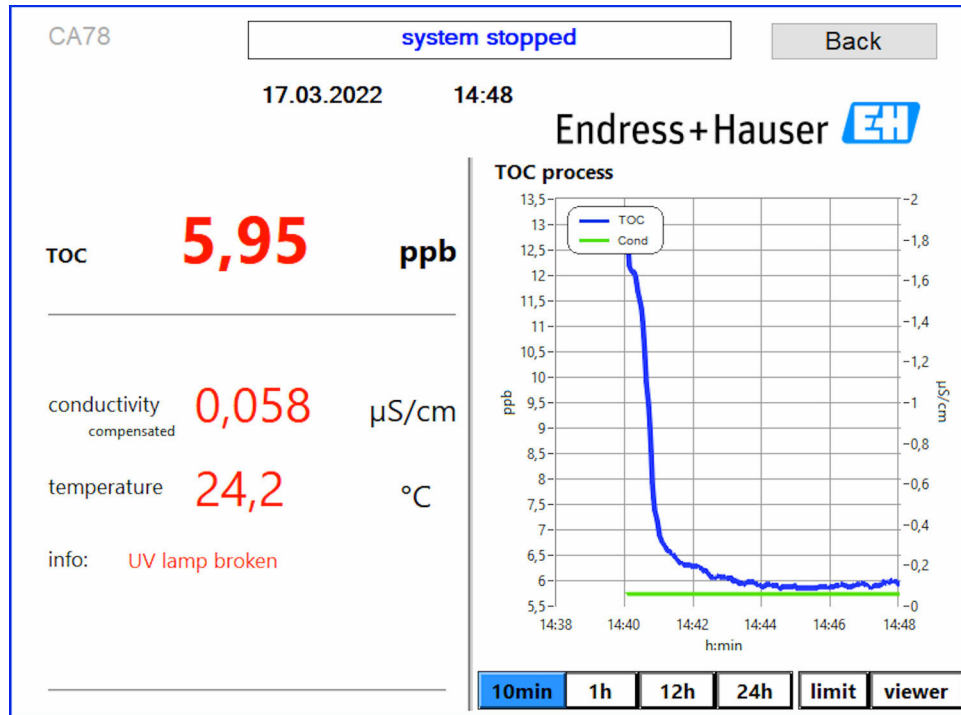

A0050169

9 UV sensor error message

### Error during sampling

This warning message can only appear with the order option **Detection inlet pressure sample**. If this message is displayed, the sensor has detected a closed input.

- Check that medium is correctly supplied to the device.

### 8.3.2 Viewer

This menu allows you to view all the TOC measured values. The data are selected and displayed by selecting the date.

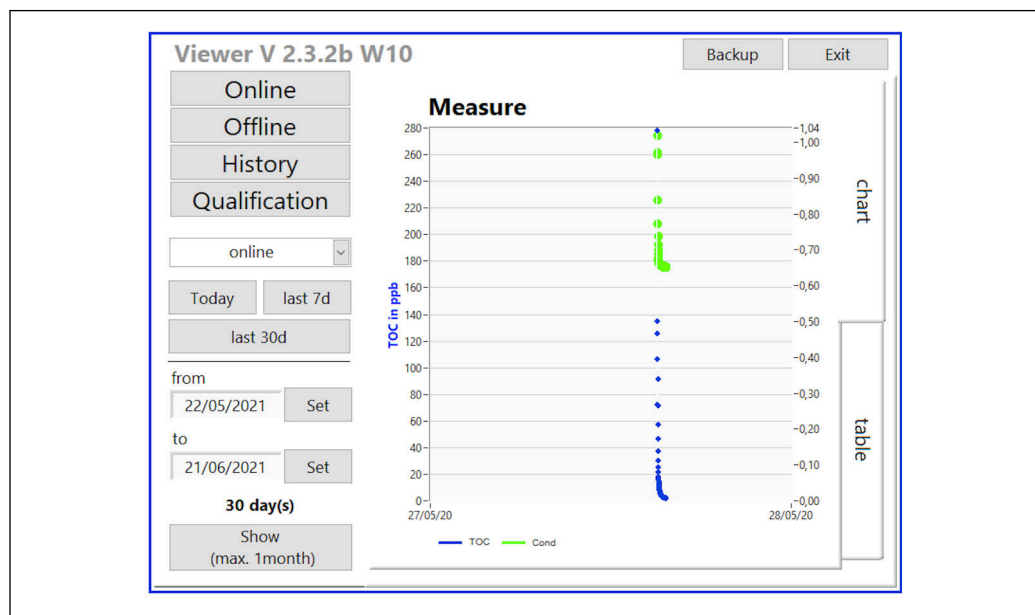

A0046962

10 Viewer menu

You can select the data as follows:

1. Make the desired preselection (e.g.: **Online**).
2. Select the date of interest under **Selected date**.
3. Select the file under **Selected data file**.
  - ↳ The selected information is shown in the chart on the right-hand side. The user can use the **Chart** or **Table** tabs to switch between displaying the information in a chart or table.

The history file is an ongoing list that acts as logbook and contains all the information about logins, errors and calibration results (successful/not successful).

In addition, you can export and print out data via this menu (if a printer is installed under WINDOWS®).

### 8.3.3 Qualification

You can select the following two functions via this menu:

- Calibration
- SST (system suitability test)

The selection is made via the drop-down menu.

Various notifications and prompts guide you through the individual functions.

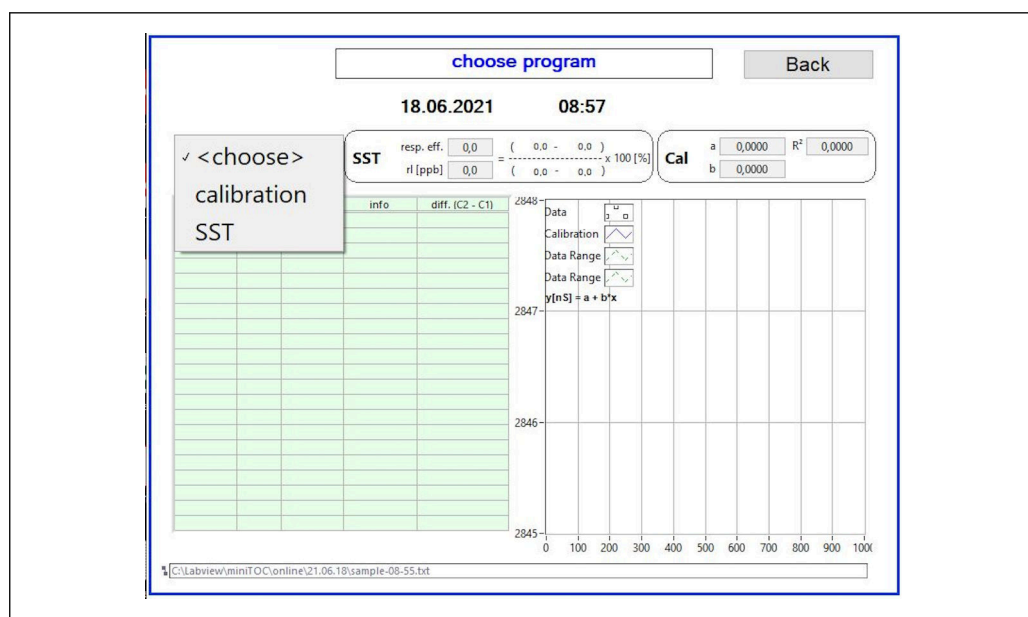

11 Qualification menu

#### Calibration and adjustment

The measurement must be stopped to perform the calibration. The system asks the user to provide the solutions. The solution concentration is specified in the **Settings** → 27 menu.

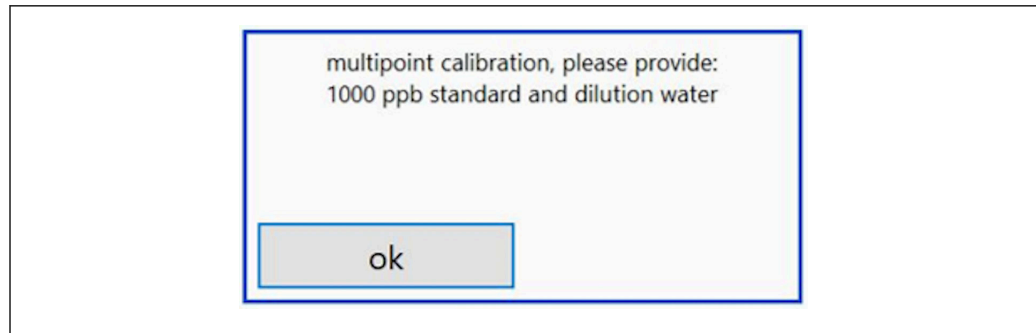

A0046947

12 "Provide solution" message

**i** The system must be switched on one hour before calibration starts so that a suitable operating temperature is reached. The calibration solutions must be warmed to at least room temperature beforehand. If temperatures below 18 °C are displayed at the start of the measurement, the measurement must be stopped until the solutions have at least reached room temperature. The optimum temperature range is between 20 and 25 °C as the starting temperature for calibration.

### Performing the calibration

1. Connect a calibration solution with the required concentration of sucrose to INPUT 1.
  - ↳ The calibration is performed semi-automatically with all the configured parameters from the **Settings** → 27 menu. After the repeat measurements of the sucrose solution, the system stops and a pop-up window appears asking the operator to connect the water solution to INPUT 1.
2. Connect the water solution to INPUT 1.
3. Close the pop-up window by pressing the **OK** key.
  - ↳ A pop-up window is displayed with the calibration results.

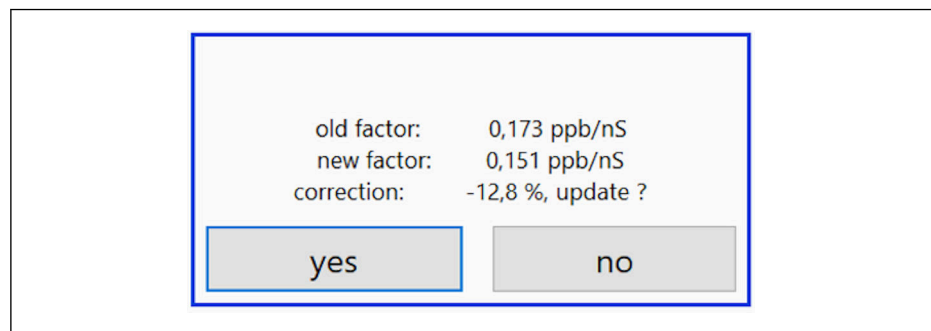

A0046949

13 Calibration factor pop-up window

4. Press the **Yes** key to confirm the result.
  - ↳ If the user chooses not to use the new calibration factor, the old calibration factor continues to be used. The calibration factor should be in the 0.11 - 0.21 ppb/nS range. Any deviations should be below 2%.



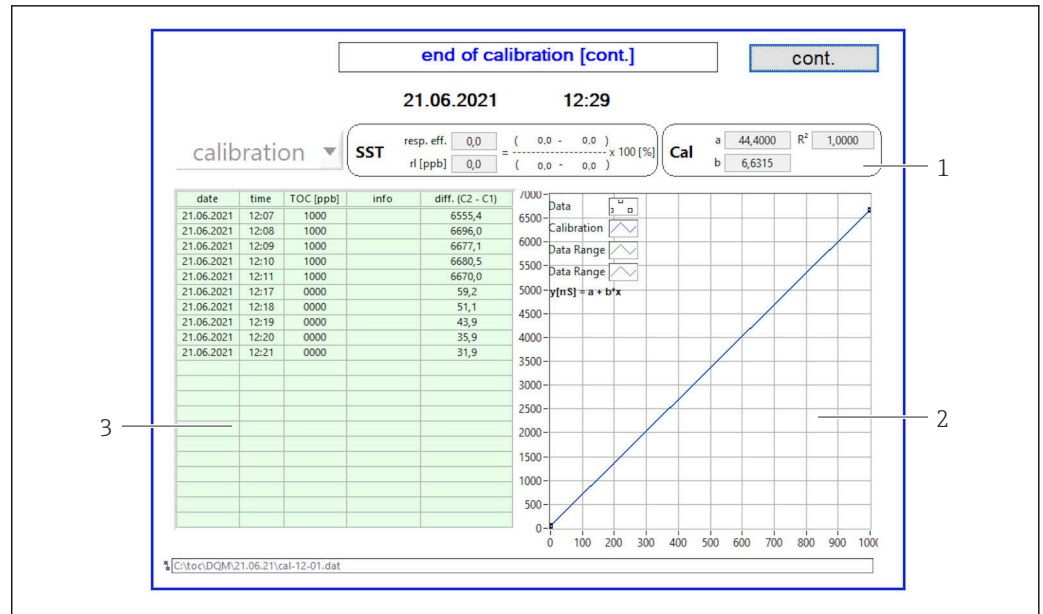

14 Calibration curve

- 1 Factors and  $R^2$
- 2 Calibration curve
- 3 List of measured values

**i** It is recommended to repeat the measurement series three times. The standard volumes used are 500 ml and suffice for several measurements. The measurement results should be constant within this measurement series and be close to one another.

### 8.3.4 System

A function check on the following components can be performed in this menu:

- Starting of the pump (normal < or fast <<<)
- Switching of the valves
- Switching on of the UV reactor
- UV sensor (detection of the intensity of the UV lamp)
- Check of the sensor signals (C1/C2)
- Check of the static pressure (option) <sup>3)</sup>
- Leak sensor
- Resetting of the operating hours (pump)
- Resetting of the operating hours (UV lamp)
- Check of the analog outputs
- Check of the digital outputs

3) If installed and enabled in the Settings menu, an empty field is displayed otherwise.

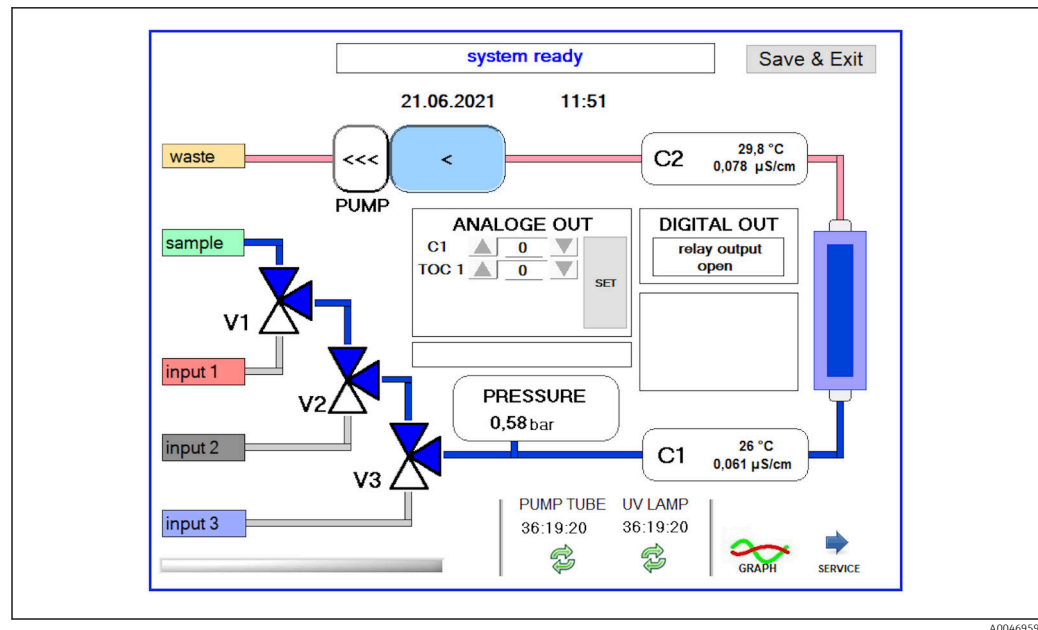

15 System menu

To change the status of the pump, the valves (V1, V2, V3) and the UV lamp, the user must press the corresponding symbol.

A chart with the following values is displayed when you press the **Graph** key → 25:

- Measured values C1 and C2
- Difference between C1 and C2
- Temperatures T1 and T2

Access to the service area is via the **Service** key. This area is password-protected (service password only for service technicians).

### Change to the main menu

1. Press the **Save & Exit** key.
  - ↳ A pop-up window appears.
2. Press the corresponding key in the pop-up window.
3. If the pump hose or the UV reactor has been changed:
  - Press the **Yes** key.
  - ↳ The operating hours are now reset.

A pop-up window appears once a menu is closed. It takes a few seconds until the analyzer has saved all the settings.

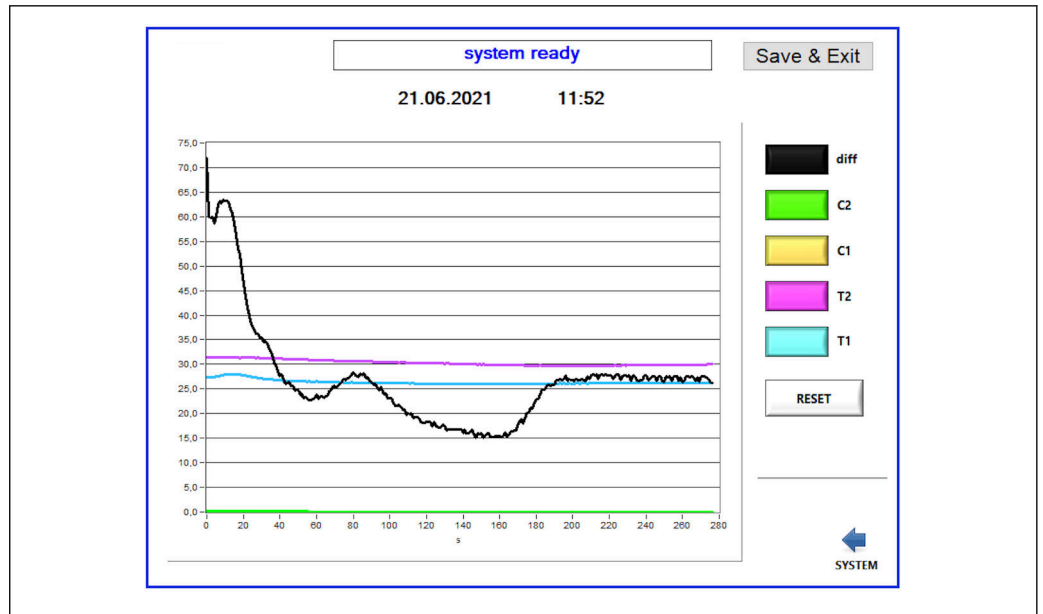

16 Chart

**i** The diagram curve of each value can be switched on or off with the individual color keys.

Pressing the **Reset** key resets all the diagram curves.

### 8.3.5 Settings

You can configure device parameters in this menu.

**License:** Enable licensing options. Only for dealers/sales partners.

**Service:** Enables additional options for authorized staff (Service 1-3).

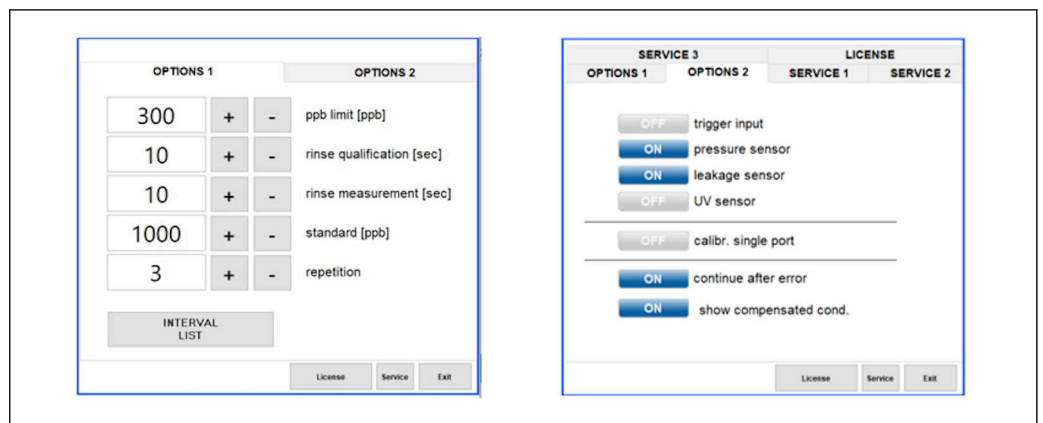

17 Settings menu

The following settings can be changed via the **Options 1** tab:

Setting	Description
ppb limit (ppb)	This limit indicates the maximum value at which the output signal for the detection limit value is switched. The maximum value for scaling the 4-20 mA outputs is also indicated here. The displayed value therefore corresponds to 20 mA.
Rinse qualification (sec)	This value indicates the rinse time (in seconds) during which a sample is introduced during a calibration (recommended value: 300 seconds).
Rinse measurement (sec)	This value indicates the rinse time (in seconds) during which a sample is introduced at the start of a measurement (recommended value: 300 seconds).
Standard (ppb)	This value can be used to define the TOC value to be used as the default value for a calibration (recommended value: 1000 ppb).
Repetition	This value indicates the number of repetitions to be performed during a calibration (recommended value: 5 repetitions).
Interval List	The interval mode editor can be opened via this key (option) →  31

It is possible to enable or disable the following hardware parts via the **Options 2** tab:

Setting	Description
Trigger input [ON/OFF]	The trigger input is enabled with this option. The trigger input ensures that the system can be started and stopped by an external contact. The analyzer remains active as long as the contact is closed (order option).
Pressure sensor	The analyzer can monitor the pressure of the selected input with the pressure sensor. If a vacuum is detected, the measurement is stopped. If a sufficient sample pressure is detected afterwards, the measurement can be resumed (with the <b>Continue after error</b> function switched on). The limit values used can be configured in the <b>Service 1</b> tab (available for order option "Detection inlet pressure sample").
Leakage sensor	The leak sensor is switched on and off with this option.
UV sensor	The sensor installed in the UV reactor is switched on and off with this option.
Calibr. single port	If a standard analyzer is used or if the corresponding ports for calibration are not available due to the set interval mode, this option can be used to force qualification at one port only (input 1). Processing of the qualification is then sequential and at the operator's request.
Continue after error	If an error occurs during the measurement, the active measurement is interrupted. Once the error has been rectified (e.g. vacuum in the measuring line), the measurement can resume automatically with this option. The device is rinsed again beforehand.
Show compensated cond.	The conductivity value in the measurement view can be changed from temperature-compensated values to uncompensated values.

The following parameters can be set in the **Service 1** tab:

Setting	Description
Temperature-Offset C1 [°C]	This value indicates the offset for temperature sensor C1.
Temperature-Offset C2 [°C]	This value indicates the offset for temperature sensor C2.
Temperature limit [°C]	This value indicates the temperature limit; if this limit is exceeded a warning is generated.
Fast pump speed	This value indicates the speed at which the rinsing is performed.
Record pause (puse x2 = delaytime)	This value indicates the intervals for recording the measured values in the log file. 1 value corresponds to 2 seconds.

Setting	Description
Max. limit conductivity [ $\mu\text{S}$ ]	This value indicates the conductivity limit; if this limit is exceeded a warning is generated.
Accuracy TOC value	This value indicates the number of decimal places used to display the TOC value.
Underpressure limit [bar]	This value is required for the <b>pressure sensor</b> option. It indicates the input pressure at the which an error should be displayed.
Underpressure restart [bar]	This value is required for the <b>pressure sensor</b> option. It indicates the pressure at which the measurement should be restarted after the vacuum is switched off.

The following parameters can be set in the **Service 2** tab:

Setting	Description
Use analog output [ON / OFF]	The analog output can be switched on or off here.
4 Channels(analog output)	If the system features the <b>Interval</b> option and 4 analog outputs, the analog outputs for TOC 2 and TOC 3 can be activated here for the additional connection.
0-20 mA (analog output)	If the system features the <b>0-20 mA</b> option, this must be configured here. Otherwise incorrect analog signals may result when scaling the TOC values. Information on the system features is provided in the final test report.
Idle analog output value (only with 0-20 mA option)	With the <b>0-20 mA</b> option, the system can adopt any value if no measurement takes place. The recommended value is 3.7 mA according to Namur NE43.
Hold the last analog output value	If values are measured in interval mode, this option can be used to specify that the analog output signals should always remain at the last measured value when the measuring inputs change, even if no measurement is currently active.

The following parameters can be set in the **Service 3** tab:

Setting	Description
UV-Limit	This value indicates the maximum period of time before a warning is generated if the operating time of the UV lamp exceeds this limit.
Pump limit	This value indicates the maximum period of time before a warning is generated if the operating time of the pump hose exceeds this limit.
Valves	This value indicates the number of valves the analyzer is fitted with. This value must be set correctly here. Otherwise, malfunctions may occur when selecting the inputs in the calibration and interval mode.
Universal digital output	If the analyzer is fitted with a universal digital output, this option can be used to configure the system events that can cause the output to switch. <b>Fault</b> - The output closes during measurement and opens during standby or in the event of an error <b>Limit</b> - The output changes if the limit value for TOC or conductivity is exceeded <b>Fault+limit</b> - The output closes during measurement and opens during standby, in the event of an error or if the TOC or conductivity limit value is exceeded.
Automatic report	At the end of the day (midnight), generates an automatic printout on the printer that is installed in the system as a standard printer.
Login dialog	Disables the login dialog (number field).

### 8.3.6 Autostart

If the system is interrupted during a measurement (due to a power outage, for example), the **Autostart** window appears when the system is restarted. If the user does not stop

autostart by pressing the **Deactivate autostart** key, the interrupted measurement is restarted.

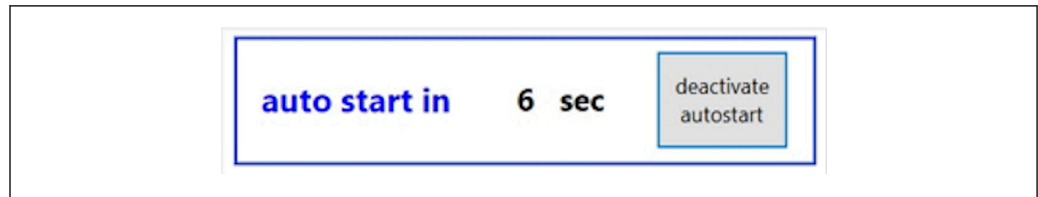

A0046966

 18 Autostart window

### Deactivating/activating autostart

1. Open the **Settings** menu.
2. Select the **Options 2** tab.
3. Activate/deactivate autostart via the **Continue after error** setting →  27.

 In conjunction with the trigger, the system only starts the measurement if the corresponding input signal is also present.

### 8.3.7 Shutdown procedure

1. Open the main menu.

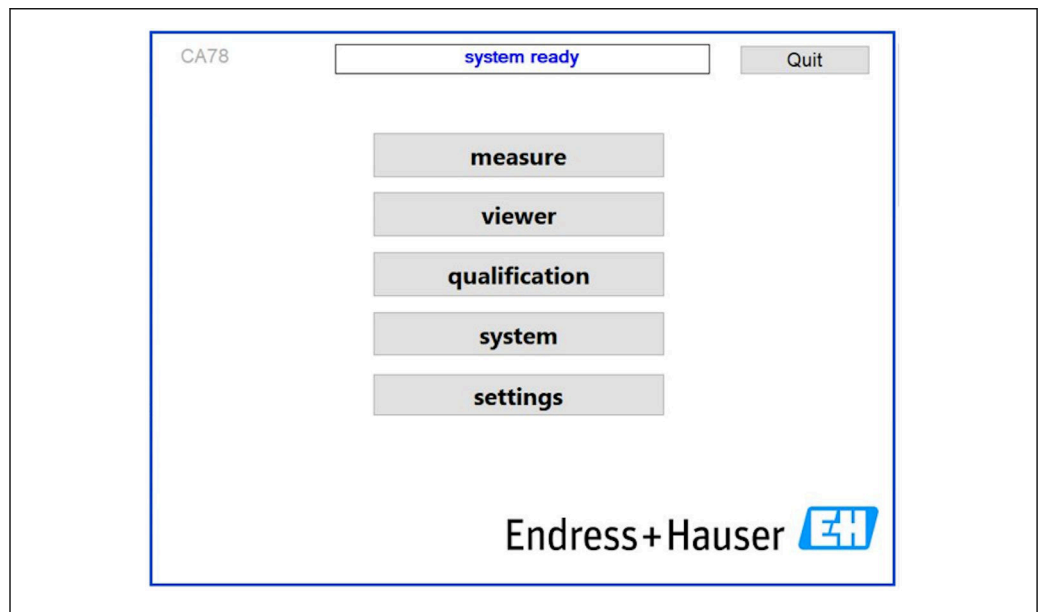

A0046941

 19 Main menu

2. Press the **Quit** key.
  - ↳ A window for authorization is displayed. The following steps must be performed for the switch-off procedure (only possible with the service ID).
3. Enter the four-digit ID (2199).
4. Press OK in the Login window.
5. Enter the four-digit PIN (9708).

6. Press OK in the Login window.

**i** Pressing the Enter character on a connected keyboard or moving the mouse to the next line will produce a login error.

A pop-up window appears once the various pages are closed. Wait for approx. 30 seconds to ensure that all the data are saved.

Once you close the software program and shut down Windows, you can switch off the device with the mains switch.

### 8.3.8 Saving measured data

The measured data should be backed up at regular intervals. A USB hub with at least 4 ports, a mouse, a keyboard and a USB stick with at least 8 GB of space are needed for the backup.

1. Shut down the system entirely .
  - ↳ The main menu is displayed.
2. Open the **Viewer** menu.
3. Press the **Online** key to select the online data.
4. Select the **Table** tab.
5. Press the **Export csv** key.
  - ↳ The file manager opens.
6. Copy the folder to be saved and save it to the connected USB stick.

### 8.3.9 Available options

#### Interval mode editor (order option)

A sequence of up to 8 combinations of port inputs between the sample, input 2 and input 3 can be created in this editor.

The interval editor can be opened via the **Interval list** key (**Settings** menu -> **Options 1** tab).

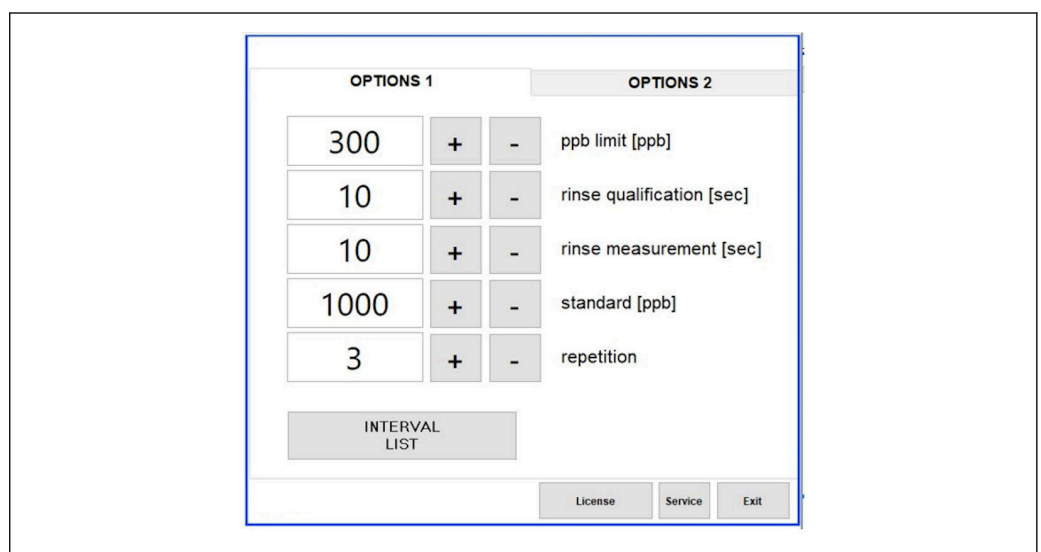

20 Settings menu, Options 1 tab

A0046973

**i** If the **Calibr. single port** option is selected, input 1 can be used for the calibration without having to disconnect the cables.

1. Press the **Interval list** key to open the interval editor.
  - ↳ The interval sequence can be edited in the editor once you press the **Interval list** key.

	Port	Time		
STEP 1	Sample	60	+	-
STEP 2	NA	1	+	-
STEP 3	NA	1	+	-
STEP 4	NA	1	+	-
STEP 5	NA	1	+	-
STEP 6	NA	1	+	-
STEP 7	NA	1	+	-
STEP 8	NA	1	+	-

OK

A0046974

 21 Editor

 The time is the measuring time with the rinse duration in minutes.

If **NA** is selected for a port in a step or if the list is completely full, the sequence starts again with step 1 in the measuring mode so that the samples are monitored continuously.

The system creates a new data file after every step. This differs from the continuous mode without an interval where a new file is created after 24 hours at the very latest if the measurement process has not been interrupted.

The first row must contain a sample and a time.



## 9 Operation

### Reading off measured values

The following measured values are displayed in the measuring screen of the analyzer:

- TOC in ppb
- Conductivity (display can be hidden as an option)
- Temperature
- Load curve: TOC, conductivity

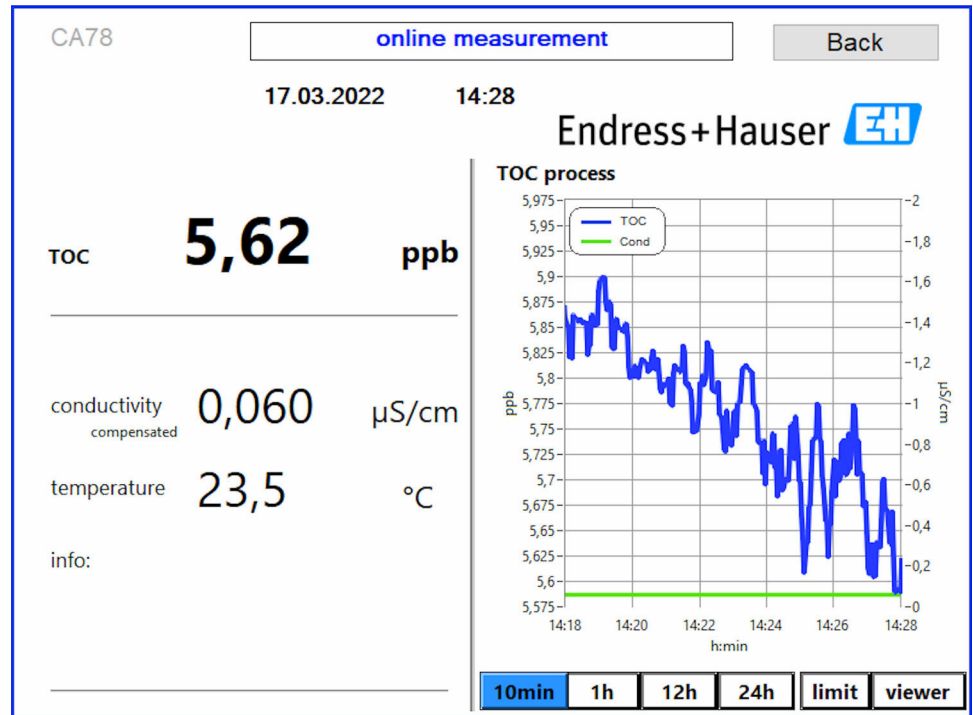

A0050167

## 10 Diagnostics and troubleshooting

### 10.1 Firmware history

Date	Version	Changes	Compatibility with earlier version
01.01.2025	1.241		Yes
01.05.2022	1.217b	Update of the Endress+Hauser figurative mark	Yes
22.11.2021	1.209	Firmware with the launch of the device	Yes

## 11 Maintenance



Incorrect maintenance can result in inaccurate operation and pose a safety hazard!

- ▶ All the maintenance processes described in this section must only be performed by a properly qualified technician.
- ▶ Before every maintenance activity: The specialist staff must be completely familiar with the entire process and have perfectly understood all the steps involved.

### 11.1 Maintenance schedule

Regular maintenance guarantees the efficient operation of the analyzer.

-  Installed hoses must not release into the medium any traces of substances that contribute to total organic carbon. The original hoses of the manufacturer are ideal.

Interval	Maintenance work
Before every calibration	▶ Replace calibration solution
Every 6 months	▶ Replace pump hose
Every 6 months	▶ Replace UV reactor
Every 24 - 36 months	▶ Replace ballast for UV reactor  Must only be performed by a service organization appointed by Endress+Hauser!
Every 36 - 48 months	▶ Replace pump head  Must only be performed by a service organization appointed by Endress+Hauser!

The maintenance intervals depend greatly on the given application. Maintenance intervals must therefore be adapted to specific needs. However, it is important to ensure that these maintenance tasks are always performed regularly!

### 11.2 Maintenance work

#### WARNING

#### Device is live!

Incorrect connection may result in injury or death!

- ▶ BEFORE starting maintenance tasks make sure that no voltage is present on any cable.
- ▶ Disconnect the device from the power supply, unplug the mains plug.

#### 11.2.1 Replacing the hose system

-  To ensure the hose fittings are seated correctly, it is advisable to cut the hoses to length with a special hose cutter to ensure a straight cut surface and to avoid the deformation of the hose ends.

The procedure for replacing a hose system is described below. The hoses used are made from FEP and are therefore unaffected by aqueous media in the pure and ultrapure water range and do not appreciably contribute to the TOC in the system.

These hose systems may need to be replaced if a large amount of contamination has entered the system or the system has been used with unsuitable media. In addition, parts of the hose system (hosing subsections) must be replaced if leaks have occurred in the system. Such leaks can be caused if an unsuitable process pressure is applied, for example.

UNF fittings, which are also used in chromatography, are used as the fittings here. These fittings consist of a suitable ferrule and a suitable screw connector (referred to as a socket below) made of PEEK.

Ferrules undergo permanent mechanical deformation during installation and must be replaced with each new hosing. The socket can be reused if it is not damaged.

The following materials are needed to replace a hosing subsection:

- 2 x ferrules (suitable for 1/8" hose, yellow color code)
- 2 x 1/4-28 UNF fittings
- 1 x 1/8" FEP hose of adequate length
- Hose cutter for capillaries

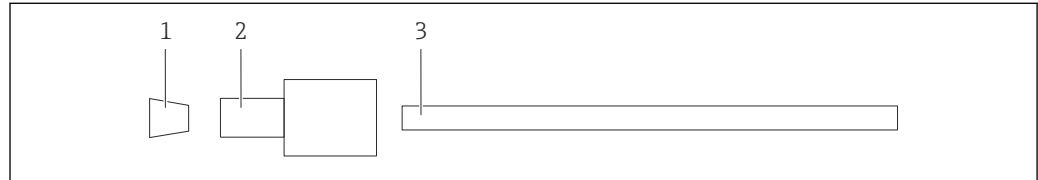

A0047336

22 Hosing subsection

- 1 Ferrule  
2 Screw connection (socket)  
3 Hose

1. Turn the fittings on the hosing subsection counterclockwise to loosen them.
2. Remove the section of hose from the housing and determine the total length of the hose.
  - ↳ The length is measured from ferrule to ferrule.
3. After determining the correct length, cut the new hose to length and cut both ends straight at right angles using the hose cutter.
4. Fit the first ferrule on one end of the hose and slide the socket over the hose.

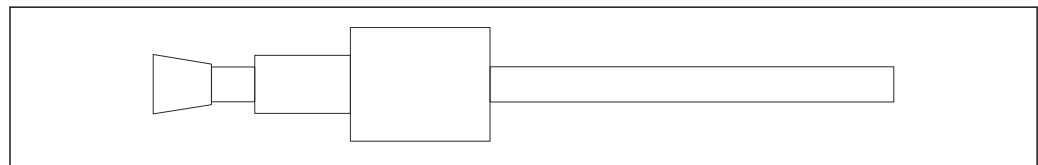

A0047337

23 Fitting the ferrule and hose in place

5. Then place the fitting (which has been prepared as explained above) into a coupling (1).

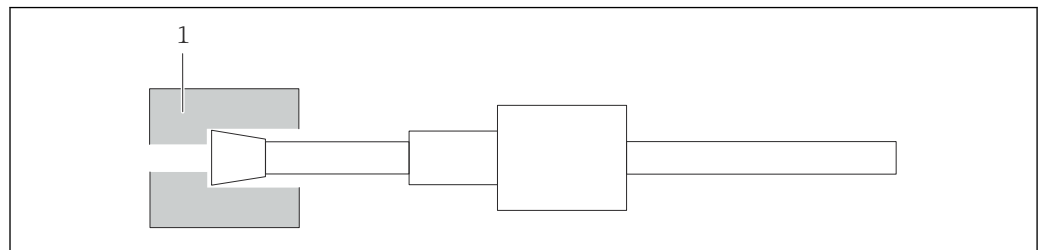

A0047338

24 Coupling

6. Screw the socket into the coupling and tighten it by hand

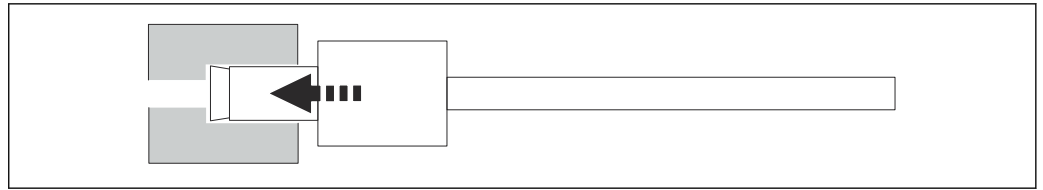

A0047339

25 Screwing in the socket

## 11.2.2 Peristaltic pump

Change the hose of the peristaltic pump every 6 months. The device software will display a reminder.

### Switching off the device

1. Stop the flow of sample entirely.
2. Shut down the system. (→ 30)
3. Switch off the device with the mains switch.
4. Disconnect the mains plug of the device.

### Replace the pump hose

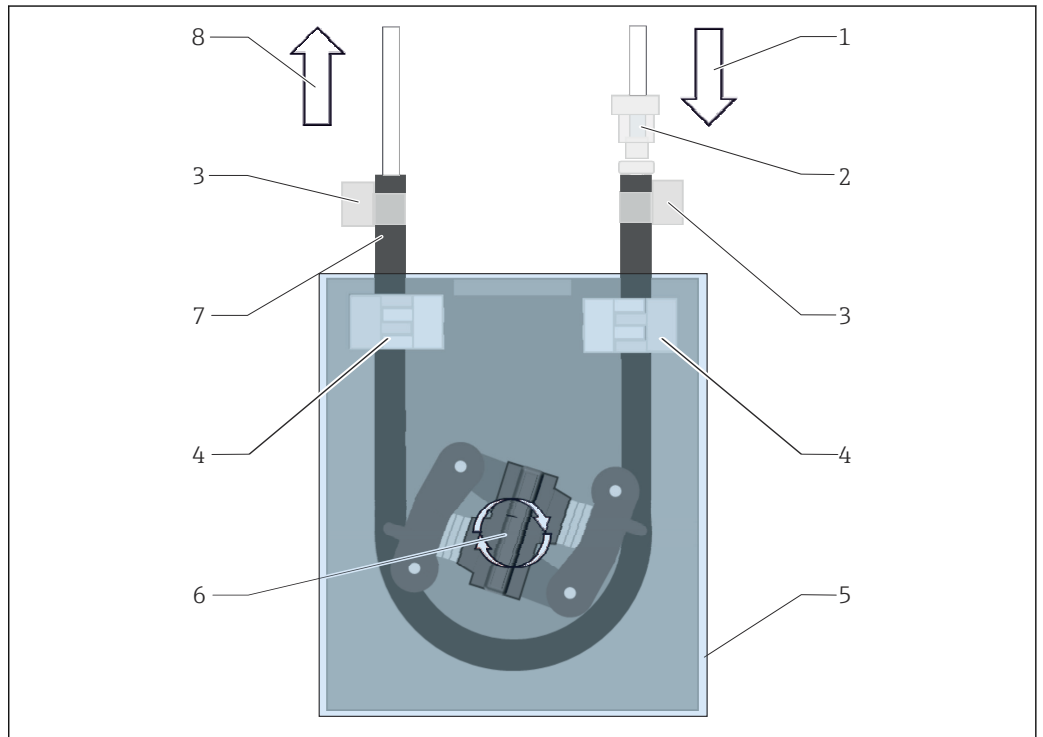

A0057856

26 Peristaltic pump

- 1 Pump inlet
- 2 Hose connector
- 3 Hose clips
- 4 Hose holders
- 5 Plastic cover
- 6 Pump head
- 7 Pump hose
- 8 Pump outlet

1. Open the device.
2. Remove the plastic cover (5).
3. Open the hose holders (4) and remove the pump hose (7) from the hose holders.

4. Open the hose clips (3) at the ends of the hose and disconnect the pump hose from the hose system.
5. Turn the pump head (6) while at the same time pulling the old pump hose out of the pump housing at one end.
6. Insert the new pump hose by turning the pump head (6) and secure it on the housing.
7. Position the pump hose in the center of the pump housing and close the hose holders (4).
8. Fit the hosing and hose connector (2) on the new pump hose and secure in place with the hose clips.
9. Attach the plastic cover.
10. Set the operating hours of the pump to zero in the **System** menu.

### 11.2.3 Reactor with UV lamp

#### **WARNING**

##### **Radiation source with short-wave UV radiation!**

Improper handling can cause damage to eyes and skin!

- ▶ Before working on the reactor, always take the device out of service and disconnect it from the power supply!
- ▶ Always replace the reactor as a complete assembly!
- ▶ Take damaged reactors out of service!
- ▶ Never open the reactor to replace individual components!
- ▶ Never operate the reactor when it is disassembled or in an unshielded state!
- ▶ Ensure the insulation at the reactor ends is intact (undamaged heat shrink tubes)!
- ▶ Dispose of broken or defective UV lamps as hazardous waste as they contain mercury.

The UV lamp in the reactor is used exclusively as a source of energy for oxidation. The radiation intensity of the lamp decreases after many operating hours until the sensor is triggered and information to this effect is shown on the display. Once the sensor switches off, the measuring point can still continue to be operated for a short time. As the intensity is significantly lower, the system should be recalibrated, however. Replace the reactor after 12 months at the very latest.

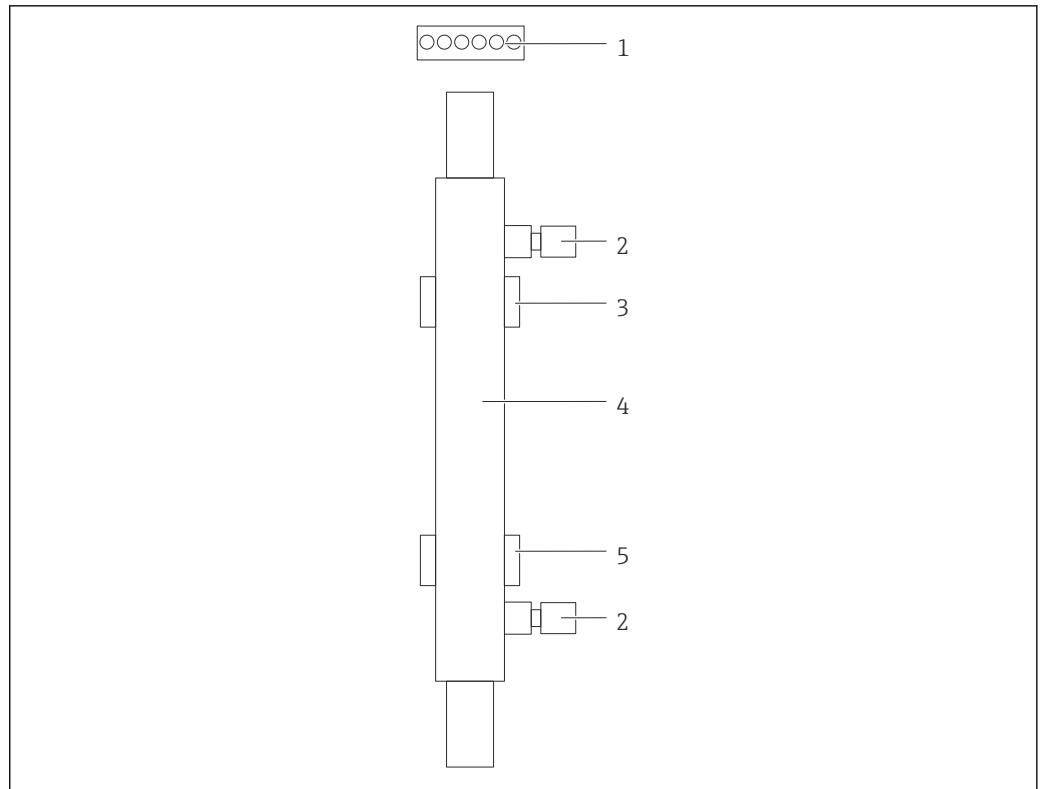

A0047340

#### 27 Reactor

- 1 Connecting plug
- 2 Fluid connection
- 3 Top holder
- 4 Reactor
- 5 Bottom holder

The following steps are necessary to replace the reactor:

1. Stop the flow of sample entirely.
2. Shut down the system → 30.
3. Disconnect fluid connections (2) to and from the reactor (4).
  - ↳ A small amount of water can escape here (residual liquid in the reactor).
4. Release the connecting plug (1) to the electronic ballast.
5. Remove the reactor from the holders of the metal housing. For this purpose, the reactor must first be removed from the top holder (3) and then from the bottom holder (5).
  - ↳ Please ensure that the glass ends of both the old and new reactor are not touched.
6. Insert the new reactor into the system. Here, the reactor must first be inserted into the bottom holder and then into the top holder.
  - ↳ When inserting the reactor, care must be taken to ensure the electronic cables to the plug are not damaged and that they are inserted behind the reactor in the groove provided for this purpose.
7. Reestablish the electronic connection to the electronic ballast and the fluid connections.
8. Restart the system.
  - ↳ The system mode checks the reactor to ensure it is functioning correctly without any errors.

9. On completion of the check, reset the operating time counter of the reactor.
  - ↳ This completes the installation of the new reactor.
-  Following a reactor replacement, the new reactor must run in system mode for at least 20 minutes at normal pump speed and with the lamp switched on. This removes any impurities and contamination. In addition, it is also essential to calibrate the new UV reactor.

## 11.3 Decommissioning

### CAUTION

#### Activities while the analyzer is in operation

Risk of injury and infection from medium!

- ▶ Before you release any hoses, make sure that no actions, such as the pumping of sample, are currently running or are due to start shortly.
- ▶ Wear protective clothing, goggles and gloves or take other suitable measures to protect yourself.
- ▶ Wipe up any spilt reagent with a disposable tissue and rinse with clear water. Then dry the cleaned areas with a cloth.

#### To take out of service, proceed as follows:

1. Stop the flow of sample entirely.
2. Rinse the analyzer with ultrapure water.
3. Empty the hoses entirely.
4. Fit blind plugs on all the inputs and outputs.



## 12 Repair

### 12.1 Spare parts

Device spare parts that are currently available for delivery can be found on the website:

<https://portal.endress.com/webapp/SparePartFinder>

- ▶ Quote the serial number of the device when ordering spare parts.

### 12.2 Return

The product must be returned if repairs or a factory calibration are required, or if the wrong product was ordered or delivered. As an ISO-certified company and also due to legal regulations, Endress+Hauser is obliged to follow certain procedures when handling any returned products that have been in contact with medium.

To ensure the swift, safe and professional return of the device:

- ▶ Check the website [www.endress.com/support/return-material](http://www.endress.com/support/return-material) for information on the procedure and general conditions.

### 12.3 Disposal

#### 12.3.1 Disposing of the analyzer

**⚠ CAUTION**

**Risk of injury if the standard solution used is disposed of incorrectly!**

- ▶ When disposing, follow the instructions of the safety data sheets for the chemicals used.
- ▶ Observe the local regulations regarding waste disposal.



If required by the Directive 2012/19/EU on waste electrical and electronic equipment (WEEE), the product is marked with the depicted symbol in order to minimize the disposal of WEEE as unsorted municipal waste. Do not dispose of products bearing this marking as unsorted municipal waste. Instead, return them to the manufacturer for disposal under the applicable conditions.

## 13 Accessories

The following are the most important accessories available at the time this documentation was issued.

Listed accessories are technically compatible with the product in the instructions.

1. Application-specific restrictions of the product combination are possible.  
Ensure conformity of the measuring point to the application. This is the responsibility of the operator of the measuring point.
2. Pay attention to the information in the instructions for all products, particularly the technical data.
3. For accessories not listed here, please contact your Service or Sales Center.

### **CA78/79 pressure reducer kit**

Supply pressure: max. 10 bar (145 psi), adjustable output pressure

Order No. 71543593

### **CA78/79 heat exchanger kit**

Temperature: can be used up to a maximum temperature of 90 °C (194 °F)

Order No. 71543592

## 14 Technical data

### 14.1 Input

Measured variable	TOC
Measuring range	0.5 to 1 000 µg/l (ppb)
Input signal	Controller input 24 V (order option) The controller input starts a measurement. The function is only available for 1-channel devices.

### 14.2 Output

Output signal	<b>Measuring channel 1</b> 0/4 to 20 mA, galvanically isolated  <b>Measuring channel 2 (optional)</b> 0/4 to 20 mA, galvanically isolated
Signal on alarm	1 port for waste UNF ¼ - 28
Load	500 Ω max.
Transmission behavior	Configurable, in the measuring range 4 to 20 mA Standby: 3.8 mA

### 14.3 Current outputs, active

Span	0 to 20 mA; according to Namur NE43
------	-------------------------------------

## 14.4 Energy supply

Supply voltage	100/240 V AC, 47 - 63 Hz
Power consumption	Max. 60 W
Power supply cable	2 m, Type E+F mains plug pre-installed

## 14.5 Performance characteristics

Measured variable	TOC (total organic carbon)
Measuring range	TOC (total organic carbon)
Maximum measurement error	+/- 0.5 µg/l (ppb) or 1 %, the larger value applies in each case
Limit of detection (LOD)	0.1 µg/l (ppb)
Response time $t_{90}$	50 s
Number of measuring channels	1 to 3, depending on the order version
Sample requirement	~ 14 ml/min.
UV reactor	UV reactor with continuous function monitoring
Calibration interval	The device is calibrated on delivery. It is recommended to perform a new calibration after replacing components in contact with the process, such as the pump hose or UV reactor.
Maintenance interval	<ul style="list-style-type: none"> <li>■ Replacement of calibration solution - before every calibration</li> <li>■ Replacement of pump hose - every 6 months</li> <li>■ Replacement of UV reactor - every 6 months</li> <li>■ Replacement of UV reactor ballast - every 24 - 36 months</li> <li>■ Replacement of pump head - every 36 - 48 months</li> </ul>
Maintenance effort	1 hour per month

## 14.6 Environment

Ambient temperature	10 to 45 °C (50 to 113 °F)
---------------------	----------------------------

Storage temperature	2 to 55 °C (35 to 131 °F)
Relative humidity	10 to 90 %, non-condensating
Degree of protection	IP54
Electromagnetic compatibility <sup>4)</sup>	Interference emission and interference immunity as per EN 61326-1:2013, Class A for Industry
Electrical safety	According to EN/IEC 61010-1:2010, Class 1 equipment Low voltage: overvoltage category II For installations up to 3 000 m (9 800 ft) above MSL
Pollution level	2

## 14.7 Process

Sample temperature	< 50 °C (122 °F)
Process pressure	Max. 0.5 bar (7.25 psi); recommended 0.25 bar (3.62 psi)
Sample outlet	Depressurized
Sample quality	Particle-free
Maximum conductivity of sample	Max. 2 µS/cm Order option: max. 10 µS/cm
pH value of the sample	Neutral
Sample supply	<ul style="list-style-type: none"> <li>▪ 1 port for sample: 1 port for calibration</li> <li>▪ Order option 1: 3 ports for sample, 1 port for calibration</li> </ul>

## 14.8 Mechanical construction

Design, dimensions	→  12
Weight	Approx. 14 kg (30.86 lb)
Materials	Stainless steel housing

4) Sufficient mains quality is required to operate the product as designated.

---

**Hose specification**

Sample hose 1/8 inch, 3.2 mm OD included in connection kit.

Distance to other devices 50 cm.

Do not exceed sample feed line of 2 meters and height difference of 1 meter.

# Index

## A

Access via local display . . . . .	18
Accessories . . . . .	42
Ambient temperature . . . . .	44
Analyzer	
Mounting . . . . .	13
Autostart . . . . .	29

## C

Calibration and adjustment . . . . .	23
Calibration interval . . . . .	44
Commissioning . . . . .	19
Configuration . . . . .	19
Connecting . . . . .	16
Connecting instructions . . . . .	16
Connecting the media . . . . .	14
Current outputs	
Active . . . . .	43

## D

Degree of protection . . . . .	16, 45
Diagnostics . . . . .	34
Dimensions . . . . .	12, 45
Disposal . . . . .	41
Disposing of the analyzer . . . . .	41
Documentation . . . . .	4

## E

Electrical connection . . . . .	16
Electrical safety . . . . .	45
Electromagnetic compatibility . . . . .	45
Energy supply . . . . .	44
Environment . . . . .	44

## F

Firmware history . . . . .	34
Function check . . . . .	19

## H

Hose specification . . . . .	46
Hose system	
Replacement . . . . .	35
Humidity . . . . .	45

## I

Identifying the product . . . . .	7
Incoming acceptance . . . . .	7
Input . . . . .	43
Input signal . . . . .	43
Installation check . . . . .	19
Installation requirements . . . . .	12
Intended use . . . . .	5
Interval mode editor . . . . .	31

## L

Load . . . . .	43
Login procedure . . . . .	19

## M

Maintenance . . . . .	35
Maintenance effort . . . . .	44
Maintenance interval . . . . .	44
Maintenance schedule . . . . .	35
Maintenance work . . . . .	35
Manufacturer's address . . . . .	8
Materials . . . . .	45
Maximum conductivity of sample . . . . .	45
Measured variable . . . . .	43
Measurement . . . . .	19
Measurement error . . . . .	44
Measuring range . . . . .	43, 44
Mounting options . . . . .	12
Mounting sequence . . . . .	13
Mounting the analyzer . . . . .	13

## N

Nameplate . . . . .	7
Number of measuring channels . . . . .	44

## O

Operation . . . . .	33
Operation options . . . . .	17
Operational safety . . . . .	5
Options . . . . .	31
Order code . . . . .	7
Output . . . . .	43
Output signal . . . . .	43
Overview of operation options . . . . .	17

## P

Performance characteristics . . . . .	44
Pollution level . . . . .	45
Post-connection check . . . . .	16
Post-installation check . . . . .	14
Power consumption . . . . .	44
Power supply . . . . .	44
Power supply cable . . . . .	44
Process . . . . .	45
Process diagram . . . . .	10
Process pressure . . . . .	45
Product description . . . . .	9
Product design . . . . .	9
Product identification . . . . .	7
Product page . . . . .	7
Product safety . . . . .	6

## Q

Qualification . . . . .	23
-------------------------	----

## R

Repair . . . . .	41
Replacing the hose (peristaltic pump) . . . . .	37
Replacing the reactor . . . . .	38
Requirements for the personnel . . . . .	5
Response time . . . . .	44

---

Return . . . . .	41
<b>S</b>	
Safety information . . . . .	4
Safety instructions . . . . .	5
Sample outlet . . . . .	45
Sample quality . . . . .	45
Sample requirement . . . . .	44
Sample supply . . . . .	45
Sample temperature . . . . .	45
Saving measured data . . . . .	31
Scope of delivery . . . . .	8
Security	
IT . . . . .	6
Settings . . . . .	27
Shutting down . . . . .	30
Signal inputs . . . . .	43
Signal on alarm . . . . .	43
Span . . . . .	43
Spare parts . . . . .	41
State of the art . . . . .	6
Storage temperature . . . . .	45
Structure and function of the operating menu . . . . .	17
Supply voltage . . . . .	44
Symbols . . . . .	4
System . . . . .	25
<b>T</b>	
Technical data . . . . .	43
Transmission behavior . . . . .	43
Troubleshooting . . . . .	34
<b>V</b>	
Viewer . . . . .	22
<b>W</b>	
Warnings . . . . .	20
Weight . . . . .	45
Workplace safety . . . . .	5











71696584

[www.addresses.endress.com](http://www.addresses.endress.com)

---