

Reference Topology ME01

Mitsubishi Electric MELSEC System Q and PROFIBUS for
Water & Wastewater Industry

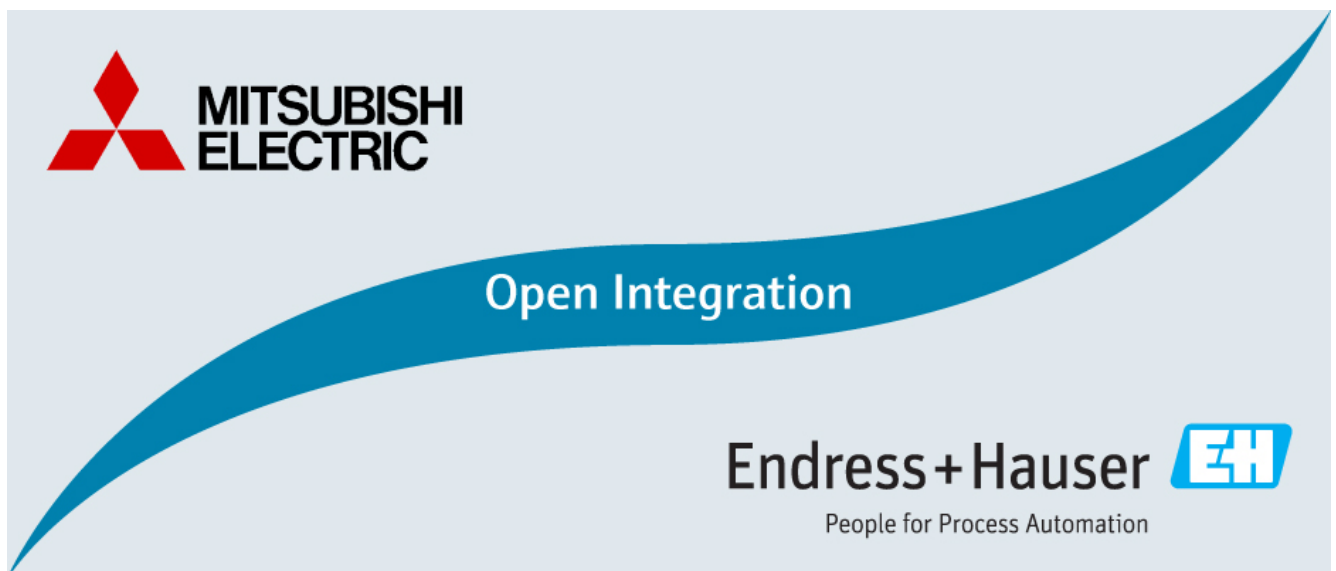

Table of Contents

1	Document Information	4
1.1	Purpose and Scope	4
1.2	Document History	4
1.3	Related Documents	4
2	Target Market.....	4
2.1	Industry Application	4
2.2	Fieldbus Technology	4
3	Reference Topology	5
3.1	Overview	5
3.2	Process Control System	5
3.3	Asset Management System	6
3.4	Field Network Infrastructure.....	7
3.4.1	PROFIBUS DP Optical Ring Network	7
3.4.2	PROFIBUS DP Cable Type A Network.....	7
3.4.3	PROFIBUS DP/PA Coupling	7
3.4.4	PROFIBUS PA Cable Type A Network.....	7
3.5	Field Devices.....	8
3.5.1	PROFIBUS DP devices.....	8
3.5.2	PROFIBUS PA devices.....	9

1 Document Information

1.1 Purpose and Scope

This document specifies the Open Integration Reference Topology ME01. All content of this document is jointly developed, reviewed and approved by Mitsubishi Electric and Endress+Hauser as a common deliverable of Open Integration.

1.2 Document History

This is version 1.00.00 of this document. Version history:

Version	Released	Description
1.00.00	2015-03	Initial version

1.3 Related Documents

Please refer to related documents as listed below:

Document	Description
SD01432S/04/EN/02.15	Integration Tutorial ME01
SD01433S/04/EN/02.15	Integration Test Summary ME01
SD01434S/04/EN/02.15	List of Tested Devices and Versions ME01

2 Target Market

2.1 Industry Application

This reference topology is designed to serve applications in Water / Wastewater industries.

2.2 Fieldbus Technology

This reference topology is designed for instrumentation with PROFIBUS DP and PROFIBUS PA.

3 Reference Topology

3.1 Overview

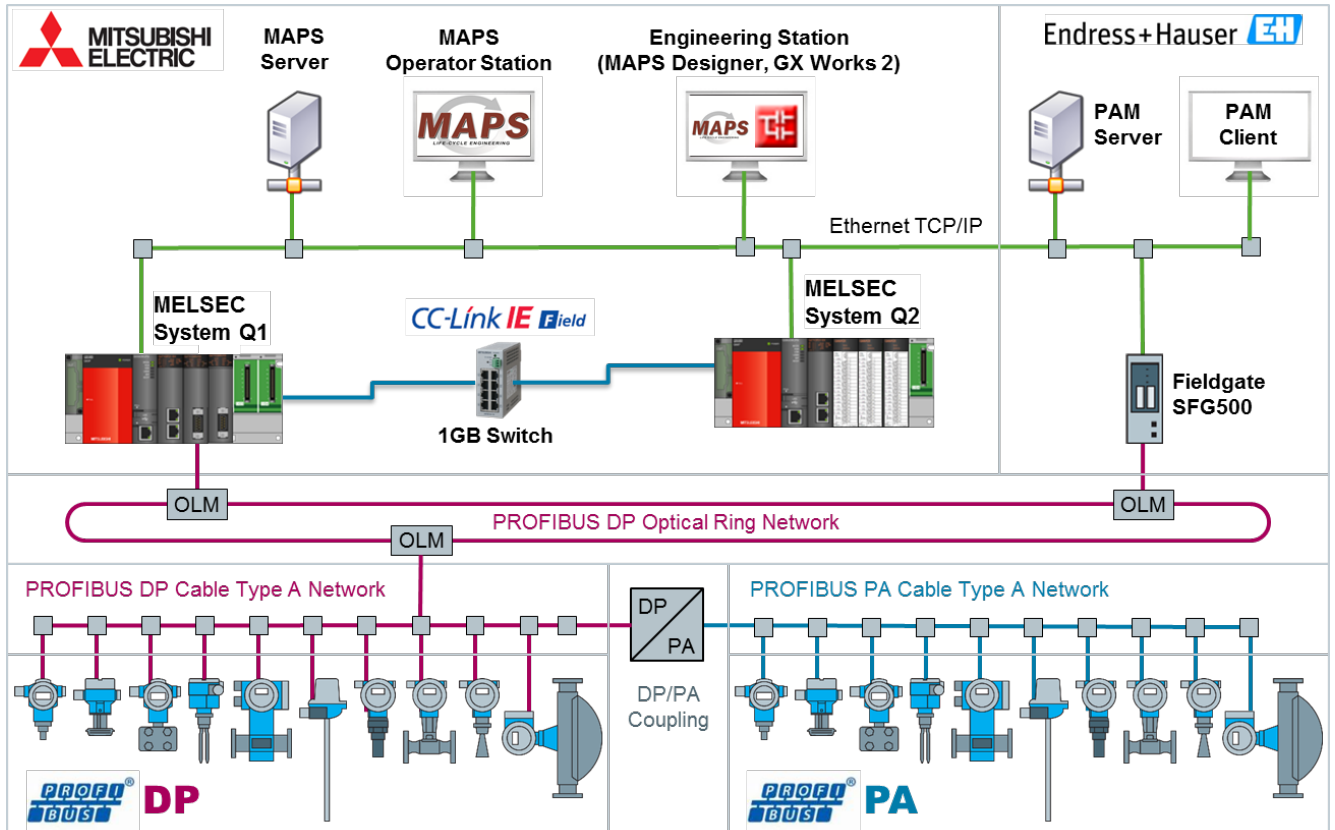





3.2 Process Control System

The process control system part top left in the overview is provided by Mitsubishi Electric:

The MELSEC System Q1 controller with PROFIBUS DP master card connects to the underlying PROFIBUS DP/PA network. This controller may be connected directly to the Ethernet based system backbone, or remotely via CC Link-IE Field network and supervisory MELSEC System Q2 in a distributed control system topology. Core element on top of the system backbone is an Engineering Station for control engineering with GX Works2, complemented with MAPS Designer to configure MAPS Server and Operator Station as runtime environment for process visualization.

Reference hardware:



	Article	Description
MELSEC System Q1 	Q35B	PLC Q Series Base unit power supply + CPU + 5 I/O slots
	Q63P	PLC Q Series Power supply 24 V DC input, 5 V DC 6 A output
	Q20UDEHCPU	PLC Q Series iQ CPU module; 4096 EA; 9.5 ns/log. Com.; 200k steps; Ethernet; USB
	QJ71GF11-T2	PLC Q Series CC-Link IE Field Master/Local Module, 1Gbps, Cat5e
	QJ71PB92V	PLC Q Series Profibus DP Mastermodule, DP-V1 Protocol, 12MBaud, IEC61158/EN50170
MELSEC System Q2 	Q35B	PLC Q Series Base unit power supply + CPU + 5 I/O slots
	Q63P	PLC Q Series Power supply 24 V DC input, 5 V DC 6 A output
	Q20UDEHCPU	PLC Q Series iQ CPU module; 4096 EA; 9.5 ns/log. Com.; 200k steps; Ethernet; USB
	QJ71GF11-T2	PLC Q Series CC-Link IE Field Master/Local Module, 1Gbps, Cat5e
	ME1AD8HAI-Q	PLC Q Series Analog module; HART; 8 inputs; current 0/4..20mA
ME1DA6HAI-Q	PLC Q Series Analog module; HART; 6 outputs; current 0/4..20mA	
CC Link IE Field Switching Hub 	NZ2EHG-T8	Industrial switching hub 1 Gbps; IEEE802.3ab (1000BASE-T); IEEE802.3u (100BASE-TX); IEEE802.3 (10BASE-T)

3.3 Asset Management System

The asset management system part top right in the overview is provided by Endress+Hauser:

FieldCare or PAM Suite Servers and Clients may access the underlying PROFIBUS DP/PA fieldbus network either via system backbone and hardware of the control system, or independently via Fieldgate SFG500.

Reference hardware:

Endress+Hauser  People for Process Automation	Article	Description
Fieldgate SFG500 	SFG500	Ethernet / PROFIBUS DP gateway
	SFM500-A1	Asset Management Module for Fieldgate SFG500

3.4 Field Network Infrastructure

3.4.1 PROFIBUS DP Optical Ring Network

The PROFIBUS DP Optical Ring Network is optional for this reference topology, with limited impact to integration tests. Specific reference hardware for this part is not yet defined; recommendable hardware may be listed here in future.



3.4.2 PROFIBUS DP Cable Type A Network

The PROFIBUS DP Cable Type A Network is mandatory for this reference topology, with limited impact to integration tests. Specific reference hardware for this part is not yet defined; recommendable hardware may be listed here in future.

3.4.3 PROFIBUS DP/PA Coupling

The PROFIBUS DP/PA Coupling is mandatory for this reference topology, with decisive impact to integration tests. Mitsubishi Electric and Endress+Hauser recommend using the SK3 Power Hub from Pepperl+Fuchs for this reference topology.

Reference hardware:

 PEPPERL+FUCHS	Article	Description
SK3 Power Hub 	MB-FB-GT	Gateway motherboard
	MB-FB-4.GEN	Fieldbus Power Hub Motherboard
	HD2-GTR-4PA	Gateway module
	HD2-FBPS-1.25.360	Fieldbus Power Supply Module
	HD2-DM-A	Diagnostic module
	ACC-MB-HSK	Shielding/grounding kit

3.4.4 PROFIBUS PA Cable Type A Network

The PROFIBUS PA Cable Type A Network is mandatory for this reference topology, with limited impact to integration tests. Specific reference hardware for this part is not yet defined; recommendable hardware may be listed here in future.





3.5 Field Devices

Open Integration reference topologies always have to be tested versus a selection of most relevant field devices for the target market defined in chapter 2.1. This serves to verify that the system under test is capable to handle a necessary variety of certified field devices. All field devices are fully compliant to standards, but may be implemented versus different version of standards and each field device typically implements only a subset of relevant compliant means.

This chapter defines only a basic set of mandatory field devices for verification of this reference topology, as agreed by Mitsubishi Electric and Endress+Hauser. For more details, please refer to latest list of tested devices and versions for this reference topology, referenced in chapter 1.3.

3.5.1 PROFIBUS DP devices

Reference hardware:

 Endress+Hauser <small>People for Process Automation</small>	Article	Description	PROFIBUS ID
 Promag 53	53W	Electromagnetic Flow Transmitter	0x1526
 Prosonic S	FMU90 FDU91	Ultrasonic Level Transmitter Ultrasonic Level Sensor	0x1540
 Liquiline	CM444 CPS11D CYK10	Liquid Analyzer Transmitter Memosens Digital pH Sensor Memosens Digital Data Cable	0x155D
 Promag 400	5W4	Electromagnetic Flow Transmitter	0x1562

3.5.2 PROFIBUS PA devices

Reference hardware:

Endress+Hauser  <small>People for Process Automation</small>	Article	Description	PROFIBUS ID
Promag 50 	50D	Electromagnetic Flow Transmitter	0x1525
Prosonic M 	FMU41	Ultrasonic Level Transmitter	0x152C
Omnigrad M 	TR10+TMT84	Temperature Transmitter	0x1551
Cerabar M 	PMP51	Absolute and Gauge Pressure Transmitter	0x1553
Deltabar M 	PMD55	Differential Pressure Transmitter	0x1554
Deltapilot M 	FMB51	Hydrostatic Level Transmitter	0x1555
Micropilot 	FMR51	Radar Level Transmitter	0x1559

www.endress.com/open-integration
