

t-switch ATT11

Flow Limit Switch for Liquids and Gases

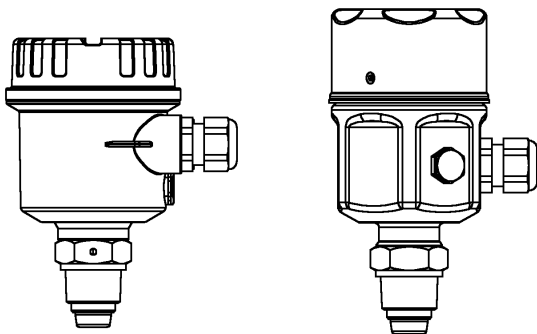

Endress + Hauser

The Power of Know How



Contents

Safety Notes	3
Handling	3
Mounting and Installation	4-10
Electrical Connection	11
Operation	12
DIL Switch Explanations	13-14
Quick Set-up Guidelines	15
Set-up Explanation	16
Set-up Procedure:	
Set Zero Flow	17
Set Maximum Flow	18
Set Setpoint (AUTO)	19
Set Setpoint (MANUAL)	20
Set Medium Selection	21
Set Relay Mode	21
Diagnostics/Error Codes	22
Technical Data	23-24
Contact Addresses	25-26

Safety Notes

The t-switch ATT11 is designed for flow limit detection in liquids and gases. The ATT11 should be installed, connected, commissioned, operated and maintained by qualified and authorised personnel only, under strict observance of these operating instructions, any relevant standards, legal requirements and where appropriate, the certificate. **Do not** attempt to install or remove the instrument under pressurised conditions.

Handling

Hold by housing or extension tube; do not hold by sensor.

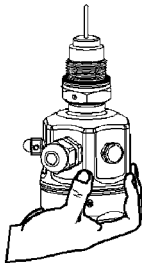

Place sensor end up. Sensor impact may cause damage.

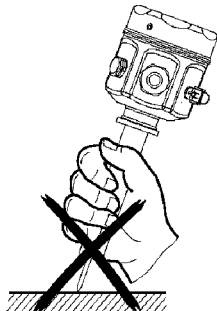
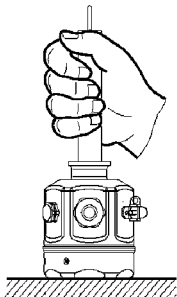

Mounting and Installation

Guidelines for Threaded Process Connections

BSP $\frac{3}{4}$ " (G)

Use appropriately sized sealing washer.

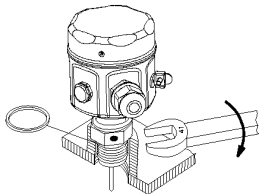

$\frac{3}{4}$ " NPT

Use a suitable thread tape to achieve a reliable seal.

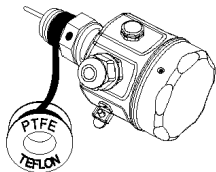

Always use a spanner to tighten the t-switch process connection.

Do not use housing to turn.

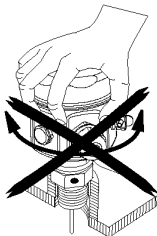

Note

For other types of process fittings follow standard good working practices.

Mounting and Installation

Sensor Orientation Markings

Every process connection has an orientation mark stamped on it. The locations of these marks are shown below and for optimum performance it is important that it is facing the flow.

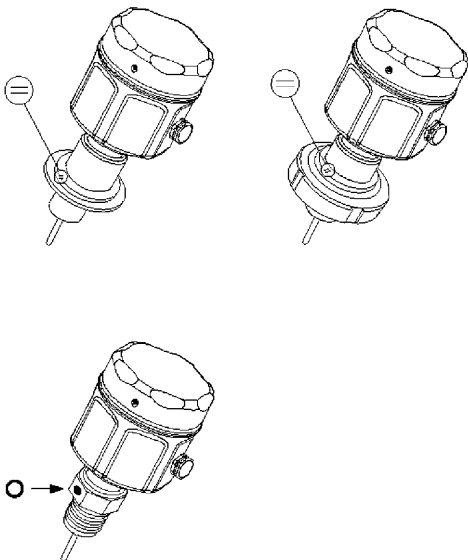

Mounting and Installation

Sensor Orientation and Flow Direction

It is important that the sensor is installed, such that the orientation mark is positioned upstream to the flowing fluid.

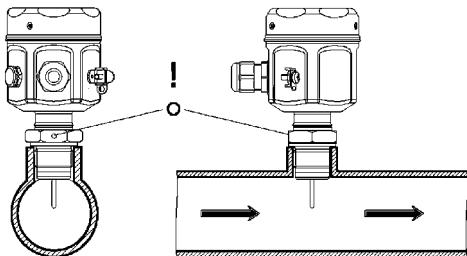

If the sensor is not installed as above it may affect the performance of the instrument.

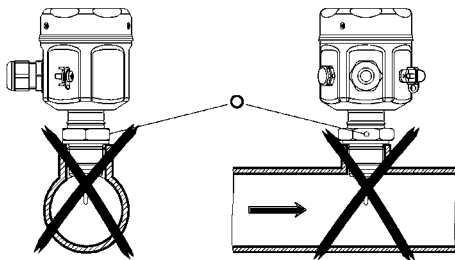

Note

Welding instructions are provided with each sensor and care should be taken to read them prior to installation.

Mounting and Installation

Insertion Depth

For optimum measuring performance the active area should be positioned anywhere between 5% and 50% of the internal pipe diameter. The sensor tip should be in contact with the medium at all times.

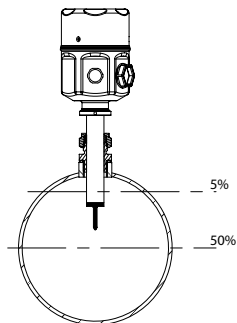

For pipe diameters <DN250

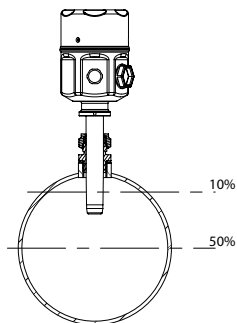

For pipe diameters \geq DN250

Each form of process connector has an orientation mark that should or = to sign be positioned in line facing the oncoming flow.

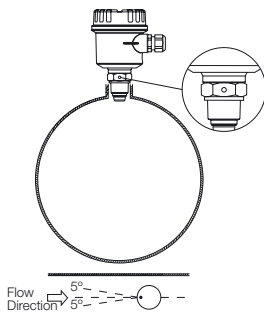

Mounting and Installation

Vertical Pipeline Flow Direction

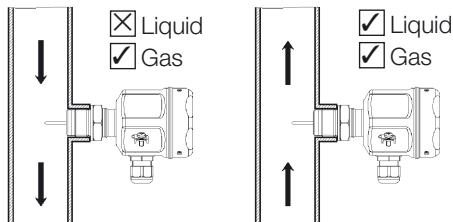

Horizontal Pipeline Positioning

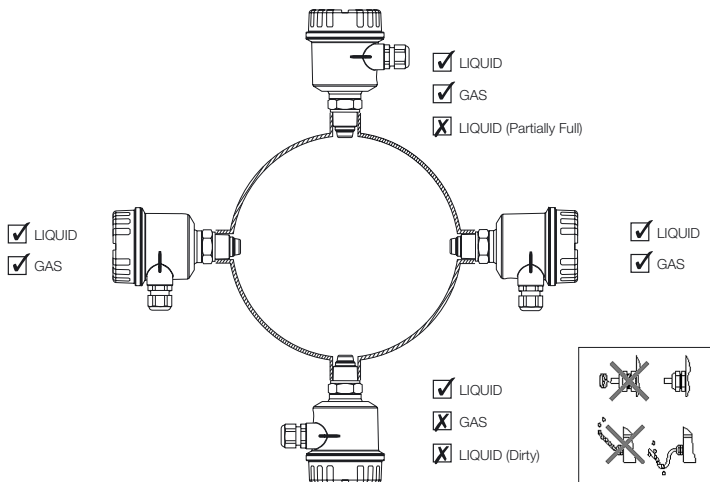

Mounting and Installation

Good installation Practice Summary

Avoid installing in areas of extreme flow turbulence. For example;

Directly after bends or expansions/reductions.

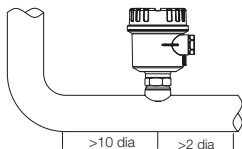

Directly downstream of isolation and control valves especially if partially opened.

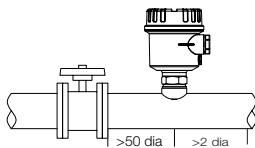

Directly after pumps, fans and compressors.

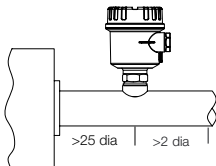

Note

All downstream dimensions provided are to be used as a guideline only and whenever possible greater dimensions should be considered.

Mounting and Installation

Sanitary Sensor Positioning (EHEDG/3A)

Standard Version

Extended Version

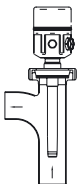
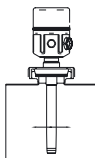
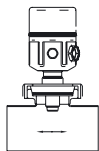

Sanitary Sensor Mounting Guideline (EHEDG/3A)

It is the responsibility of the user to ensure that the volume enclosed by the mounting boss has sufficient dimensions to ensure adequate cleaning takes place. Typically the height should be kept to less than one third of the diameter of the boss ($H \leq 1/3D$).

For example (in mm)

	D	H
DN40	42.7	14.2
DN50	54.8	18.2

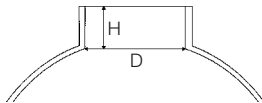

Guidelines provided relate to the dimensions of the mounting boss and not the process pipe!

Electrical Connection



Warning!

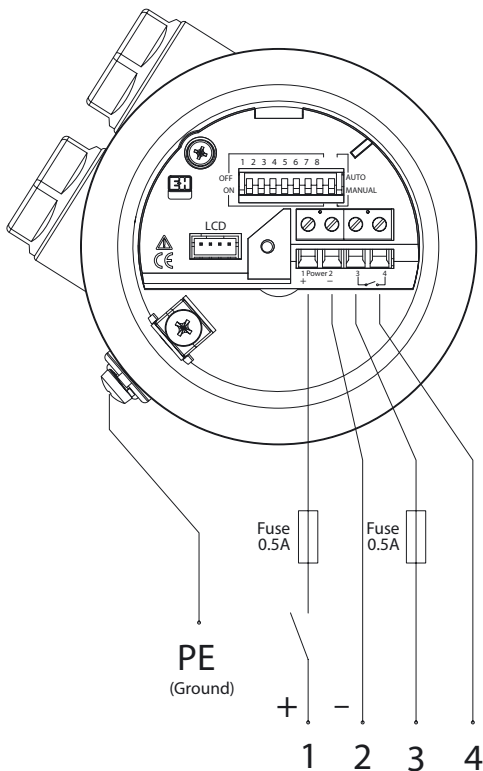

Power supply

u: 18-30V AC/DC

Output

Potential-free contact

24V DC @ 0.5A

120V AC @ 0.5A

**For AC operation
terminals 1+2 are
not polarity sensitive.**

Note

In order to meet EMC requirements, screened or shielded cable is recommended. The screen or shield should be earthed at the sensor end only.

Operation

DIL Switches (Dual in Line)

The dual-in-line (DIL) switches are used to configure the following parameters within the device.

- Zero Flow
- Maximum Flow
- Setpoint
- Medium (liq/gas) Selection
- Relay Setpoint Mode

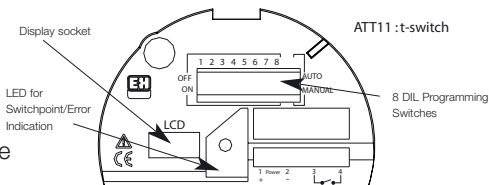

LED (Light Emitting Diode)

Illuminated when measured flow above setpoint.

Off when measured flow below setpoint.

Flashes to indicate an error.

LCD (Liquid Crystal Display) – Optional

Used to indicate flow as a percentage of the maximum.

Also displays programming information and status/error codes.

The display is not essential for programming.

DIL Switch Explanations

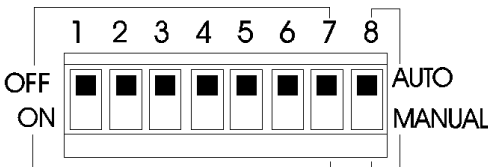

The operation of DIL 1-4 depends on the position of DIL 8.

If DIL 8 = AUTO

Then DIL 1-4 are used for AUTOLOAD features. AUTOLOAD is the means by which actual process flow conditions can be sampled and stored in memory, as either Zero Flow, Maximum Flow or Setpoint. Each parameter has a designated DIL switch combination as described on the following page.

If DIL 8 = MANUAL

Then DIL 1-4 are used to select a setpoint from a table of available values (%). Each value has a designated DIL switch combination (see page 19).

- DIL 8 is used to set the operation mode of DIL 1-4.
- DIL 7 is used to configure the relay switching operation.
- DIL 5 and 6 are used to select the medium and its appropriate calibration curve.
- DIL 1-4 are used to set all parameters related to flow i.e. zero flow, maximum flow and setpoint.

DIL Switch Explanations

All of the AUTOLOAD features and their corresponding DIL switch combinations are shown below. (DIL Switch 8 = Auto)

DIL 1	DIL 2	DIL 3	DIL 4	Description
OFF	OFF	OFF	OFF	Normal Run Mode
OFF-ON-OFF	ON	OFF	OFF	Autoload Zero Flow
OFF-ON-OFF	OFF	ON	OFF	Autoload Maximum Flow
OFF-ON-OFF	OFF	OFF	ON	Autoload Setpoint
OFF-ON-OFF	ON	ON	ON	Restore Defaults
ON	ON	ON	OFF	View Autoload Status Value

DIL 1 Operation

Toggling of DIL 1 (off-on-off) within 2.5 seconds initiates the relevant AUTOLOAD functions selected by the positions of DIL 2-4. This action causes the instrument to sample the process flow signal for 3 seconds and store it in the microprocessor memory.

Restore Defaults

To clear all stored AUTOLOAD values set DIL switch positions to configuration shown in above table.

Status (display only)

When the DIL switches are set to 'View Autoload Status' a code will appear on the display (if fitted). Each digit represents one of the three AUTOLOAD parameters. '0' and '1' represent no data stored and data stored respectively. e.g. S110 – zero and max. stored, but not setpoint.

Displayed Status Values	Description
S 0 0 0	Factory Defaults
S 1 X X	Zero Autoloaded
S X 1 X	Maximum Autoloaded
S X X 1	Setpoint Autoloaded

Quick Set-up Guidelines

These instructions are intended to allow a first time user to set up a flow switch to meet it's basic requirement. Ensure that the device is fitted with appropriate sensor (flat face = liquid, probe = gas).

AUTOLOAD Zero

This function is used to set the zero-point at operating conditions with no flow. This operation is crucial to the operation of the device and must be carried out every time,

- a) a new device is installed.
- b) the process changes significantly.
- c) the sensor is restored to factory defaults.

AUTOLOAD Maximum (Optional)

This function is used to set an actual process flow as the 100% flow value. This action will,

- a) allow the optional display to indicate a meaningful value (%).
- b) assign a meaningful range to the MANUAL setpoints.

Setpoint

There are two alternative methods for selecting the setpoint.

Option 1) AUTOLOAD Setpoint

This function is used to set a setpoint at an actual process flow anywhere between zero and maximum. Using AUTOLOAD to set the setpoint provides the best resolution.

Option 2) MANUAL Setpoint

This function is used to set a setpoint at fixed percentage intervals up to 90% of the maximum flow value. The available values are shown in the table on page 20. The values in the table refer to the factory default range or, if the AUTOLOAD max is used, the users maximum flow range.

Set-up Explanation

There are basically two set-up procedures. They are,

Option 1

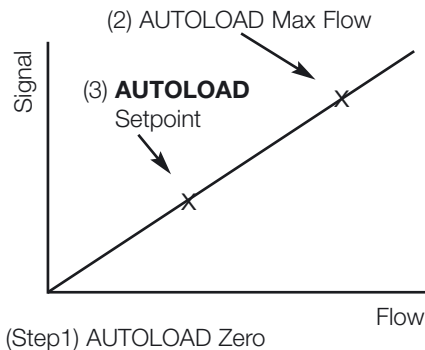

Option 2

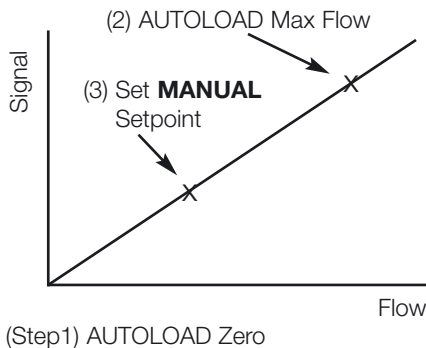

Set-up Procedure

Set Zero Flow

This function is used to set the zero-point and appropriate operating curve.

- 1) Ensure switch is installed at process operating conditions with no flow.
- 2) Set DIL switches as shown.

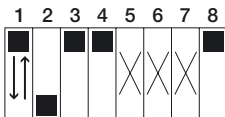

(X = Position not relevant)

- 3) Sample flow signal by toggling DIL 1 (OFF-ON-OFF within 2.5 seconds).

If a display is fitted it will show *ZERO* for 3 seconds during sampling or an error message will be displayed.

- 4) If no further AUTOLOAD functions are required, return DIL switches to NORMAL RUN MODE as below otherwise proceed to next AUTOLOAD function.



(X = Position not relevant)

The LED will change state during sampling, returning to its initial state at the end of the sampling period. If the LED flashes the AUTOLOAD has not been accepted (see page 22).

Set-up Procedure

Set Maximum Flow

This function is used to set an actual process flow condition as the 100% flow value.

- 1) Ensure switch is installed at process conditions with flow running at maximum.
- 2) Set DIL switches as below.



(X = Position not relevant)

- 3) Sample flow signal by toggling DIL 1 (OFF-ON-OFF within 2.5 seconds).

If a display is fitted and the AUTOLOAD has been successful it will show *FULL* for 3 seconds during sampling.

- 4) If no more AUTOLOAD functions are required return DIL switches 1-4 to NORMAL RUN MODE as below otherwise proceed to next AUTOLOAD function.



(X = Position not relevant)

The LED will change state during sampling, returning to its initial state at the end of the sampling period. If the LED flashes the AUTOLOAD has not been accepted (see page 22).

Set-up Procedure

Set Setpoint (AUTO)

This function is used to set a setpoint at an actual process flow anywhere in between the zero and maximum flow settings.

- 1) Ensure switch is installed at process conditions with flow running at required setpoint.
- 2) Set DIL switches as below.

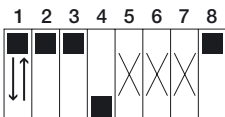

(X = Position not relevant)

- 3) Sample flow signal by toggling DIL 1 (OFF-ON-OFF within 2.5 seconds).

If a display is fitted and the AUTOLOAD is successful it will show SON for 3 seconds followed by the value for 3 seconds during sampling.

- 4) In order to utilise the AUTOLOADED setpoint return DIL 1-4 to the NORMAL RUN MODE as below and leave DIL 8 = AUTO.



(X = Position not relevant)

The LED will change state during sampling, returning at the end of the sampling period. If the LED flashes the AUTOLOAD has not been accepted (see page 22).

Set-up Procedure

Set Setpoint (MANUAL) DIL 8 = Manual

This function is used to set a setpoint as a percentage of the maximum using DIL switch combinations from the table shown.

DIL 1	DIL 2	DIL 3	DIL 4	Setpoint (% of Maximum)
OFF	OFF	OFF	OFF	5
OFF	OFF	OFF	ON	10
OFF	OFF	ON	OFF	15
OFF	OFF	ON	ON	20
OFF	ON	OFF	OFF	25
OFF	ON	OFF	ON	30
OFF	ON	ON	OFF	35
OFF	ON	ON	ON	40
ON	OFF	OFF	OFF	45
ON	OFF	OFF	ON	50
ON	OFF	ON	OFF	55
ON	OFF	ON	ON	60
ON	ON	OFF	OFF	65
ON	ON	OFF	ON	70
ON	ON	ON	OFF	80
ON	ON	ON	ON	90

1) In order to utilise the MANUAL setpoint DIL 8 must be left set to MANUAL.

If a display is fitted it will show *So*n for 3 seconds followed by the value for 3 seconds after any change of DIL 1-4.

Important Note:

Zero and maximum values can be set using Autoload function and will remain active if setpoint is set by using Manual operation.

Set-up Procedure

Set Medium Selection

This function is used to select a calibration curve for either liquid or gas.

This operation is independent of the position of DIL8.

DIL 5	DIL 6	Selection	Flat Face	Probe
OFF	OFF	L1	X (liquids only)	
OFF	ON	L3	DO NOT USE	DO NOT USE
ON	OFF	A2	DO NOT USE	DO NOT USE
ON	ON	A3		X (gas only)

If a display is fitted it will show F1 for 3 seconds followed by the selected curve for 3 seconds after any change of DIL 5-6.

Set Relay Mode

This function is used to configure the relay action at the switching point.

This operation is independent of the position of DIL8.

DIL 7	Mode
OFF	Energise at setpoint
ON	De-Energise at setpoint

If a display is fitted it will show either *EnEr* or *dEEen* for 3 seconds after changing DIL 7.

Diagnostics/Error Codes

Sensor Faults		Action
E001	Sensor Open Circuit	Replace sensor
E002	Sensor Short Circuit	Replace sensor
Output Faults		Remove electronic insert, check board connections.
E010	Relay not functioning	
Power Faults		
E100	Internal Power Fault	
E200	Power Supply out of range	
E300	E100 + E200	

AUTOLOAD Errors		Cause
Err1	AUTOLOAD Zero	Zero being set is higher than FS
Err2	AUTOLOAD Max.	FS being set below zero value
Err3	AUTOLOAD Setpoint	Being set above or below FS or zero

LED Operation (normal running)	Cause
LED on for 2 sec off for 0.25 sec	Measurement over-range
LED off for 2 sec on for 0.25 sec	Measurement below zero setting

Technical data

Process Conditions

- Nominal Process Diameters: DN25 ... 1000
- Process Pressure Range: 25 Bar g (Process fitting dependent)
- Process Temperature Range: -10 to +80°C

Materials

- Meter Body: 1.4404/1.4435/316L
- Transducers: 1.4404/1.4435/316L
- Polyester Housing: PBT-FR (polyester) with cover in PBT-FR or with transparent cover in PA 12, Seal of cover; EPDM
- Steel Housing: 1.4301 (AISI 304), seal of cover silicone
- Cable Gland: Polyamide

Process Connections

- Parallel thread BSP $\frac{3}{4}$ " (includes brass $\frac{3}{4}$ " compression fitting for insertion sensors only)
- Tapered thread $\frac{3}{4}$ " NPT (includes brass $\frac{3}{4}$ " compression fitting for insertion sensors only)
- Sanitary coupling DN40, 50 to DIN 11851
- Varivent DN50 to factory standard Tuchenhagen
- Triclamp 1 $\frac{1}{2}$ ", 2" to ISO 2852
- Aseptic coupling DN50 to DIN 11864

Performance Limits

- Accuracy: $\pm 5\%$ of full scale
- Repeatability: $\pm 1\%$ of full scale
- Time Response Flat Face: 5 sec rising, < 5 sec falling
- Time Response Probe: 15 sec rising, 10 sec falling
- Flow Ranges Liquid: 0-3m/sec ref. to water
- Flow Ranges Gas: 0-50Nm/sec ref. to air

Human interface

- Electronic Insert: 8 DIL switches for commissioning
- Red LED to indicate switching status, flashes under fault condition
- Optional Display: 4 numeric characters with bar graph

Electrical

- Power Supply: 18-30V DC / AC (50/60 Hz)
- Power Consumption: <3W
- Relay Output: Selectable Normally Closed (NC) or Normally Open (NO) (NO as factory default)

Environment

- Storage Temperature Range: -20 to +80°C (without LCD)
- Ambient Temperature Range: -10 to +65°C (without LCD)
- Degree of Protection: Polyester and steel housings: IP66 to EN 60529
- Vibration Resistance: Up to 1g, 10....150Hz to IEC 60068-2-6
- Shock Resistance: to IEC 60068-2-31
- Electromagnetic Compatibility (EMC): IEC 801 part3: E = 10V/m (30MHz...1GHz)

Approvals

EHEDG, all wetted materials FDA listed. Meets the requirements of 3A.

Approvals Pending

CSA General Approval, FM General Approval.

Contacts

Argentina

Endress+Hauser
(Argentina) S.A.
+54 (11) 45227970
+54 (11) 45227909
endress_argentina@arnet.
com.ar

Australia

Endress+Hauser
(Australia) PTY.LTD.
+61 (2) 97747444
+61 (2) 97744667

Austria

Endress+Hauser GmbH
+43 (1) 88056-0
+43 (1) 88056-335
info@at.endress.com

Belgium

Endress+Hauser S.A./N.V.
+32 (2) 2480600
+32 (2) 2480553
info@be.endress.com

Bosnia-erzegovina

Endress+Hauser
Instruments International
+387 (33) 650409
+387 (33) 467740
sovicz@yahoo.com

Brazil

Samson Endress+Hauser
Ltda.
+55 (11) 50313455
+55 (11) 50313067
info@samson-
endress.com.br

Canada

Endress+Hauser
(Canada) Ltd.
+1 (905) 6819292
+1 (905) 6819444
info@ca.endress.com

Chile

Endress+Hauser
(Chile) Ltd.
+56 (2) 3213009
+56 (2) 3213025
info@endress.cl

China

Endress+Hauser
(Shanghai) Instrumentation
Co. Ltd.
+86 (21) 54902300
+86 (21) 54902303
ehsh@public.sta.net.cn

China

Endress+Hauser (Beijing)
Instrumentation Com.LTD
+86 (10) 65882468
+86 (10) 65881725
ehbj@cn.endress.com

Croatia

Endress+Hauser
GmbH+Co. Zagreb Office
+385 (1) 6637785
+385 (1) 6637823
endress+hauser@zg.tel.hr

Czech Republic

Endress+Hauser
(Czech Republik) s.r.o.
+420 (2) 66784200
+420 (2) 66784179
info@endress.cz

Denmark

Endress+Hauser A/S
+45 (70) 131132
+45 (70) 132133
info@dk.endress.com

Finland

Metso Endress+Hauser Oy
+358 (9) 204 83 160
+358 (9) 204 83 161
info@fi.endress.com

France

Endress+Hauser S.A.
+33 (389) 696768
+33 (389) 694802
info@fr.endress.com

Germany

Endress+Hauser
Messtechnik GmbH+Co.
+49 (7621) 97501
+49 (7621) 975555
info@de.endress.com

Hong Kong

Endress+Hauser (H.K.) Ltd
+852 25283120
+852 28654171
ehhk@netvigator.com

Hungary

Endress+Hauser
(Budapest) Magyarorszag
+36 (1) 4120421
+36 (1) 4120424

India

Endress+Hauser
(India) Pvt. Ltd.
+91 (22) 6938333
+91 (22) 6938330
ehibo@bom3vsnl.net.in

Ireland

Flomeaco Endress+Hauser
Ltd.

+353 (45) 868615

+353 (45) 868182

flomeaco@iol.ie

Italy

Endress+Hauser S.p.a.

+39 (02) 92106421

+39 (02) 92107153

info@it.endress.com

Japan

Sakura Endress Co. Ltd.

+81 (422) 540611

+81 (422) 550275

info@sew.co.jp

Korea

Endress+Hauser
(Korea) Co. Ltd.

+82 (2) 6587200

+82 (2) 6592838

info@rok.endress.com

Malaysia

Endress+Hauser
(M) Sdn. Bhd.

+60 (3) 7464848

+60 (3) 7468800

infokl@my.endress.com

Mexico

Endress+Hauser
(México) S.A. de .V.

+52 (5) 568-2405

+52 (5) 568-7459

EH.Mexico@ii.endress.com

Netherlands

Endress+Hauser B.V.

+31 (35) 6 95 86 11

+31 (35) 6 95 88 25

info@nl.endress.com

Norway

Endress+Hauser A/S

+47 32 85 98 50

+47 32 85 98 51

firmapost@endress.no

Philippines

Endress+Hauser

Philippines Inc.

+63 (2) 6 38 80 41

+63 (2) 6 38 80 42

Poland

Endress+Hauser Polska
Sp. z o.o.

+48 (22) 7 20 10 90

+48 (22) 7 20 10 85

ehpl@endress.com.pl

Rep. South Africa

Endress+Hauser (Pty.) Ltd

+27 (11) 2628000

+27 (11) 2628062

info@sg.endress.com

Russia

Endress+Hauser
GmbH+Co

+7 (095) 1587564

+7 (095) 1589871

endress@dataforce.net

Singapore

Endress+Hauser

(S.E.A.) Pte. Ltd

+65 5 66 82 22

+65 5 66 68 48

info@sg.endress.com

Slovenia

Endress+Hauser
Slovenija) D.O.O.

+386 (61) 5192217

+386 (61) 1592298

endress-hauser@e-h.si

Spain

Endress+Hauser S.A.

+34 (93) 4 80 33 66

+34 (93) 4 73 38 39

info@es.endress.com

Sweden

Endress+Hauser AB

+46 (8) 55 51 16 00

+46 (8) 55 51 16 55

endress@se.endress.com

Switzerland

Endress+Hauser Metso AG

+41 (61) 7 15 75 75

+41 (61) 7 11 16 50

info@ch.endress.com

Thailand

Endress+Hauser
Thailand) Ltd.

+66 (2) 9 96 78 11-20

+66 (2) 9 96 78 10

United Kingdom

Endress+Hauser Ltd

+44 (161) 2 86 50 00

+44 (161) 9 98 18 41

publicity@uk.endress.com

USA

Endress+Hauser

Systems & Gauging Inc.

+1 (770) 447 92 02

+1 (770) 447 57 67

keith@coggins.com

USA

Endress+Hauser Inc.

+1 (317) 5 35 71 38

+1 (317) 5 35 84 98

info@us.endress.com

