



Level



Pressure



Flow



Temperature



Liquid
Analysis



Registration



Systems
Components



Services



Solutions

Brief Operating Instructions

Levelflex M FMP41C Interface

Guided Level-Radar

HART 
COMMUNICATION PROTOCOL

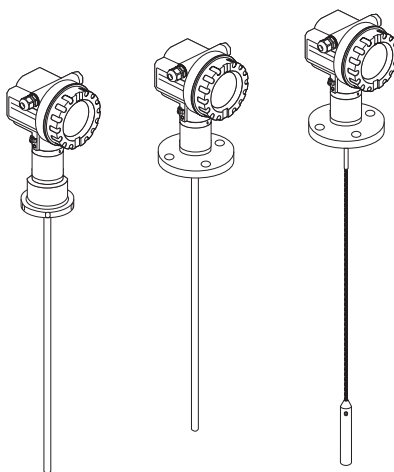

These are Brief Operating Instructions.

For more detailed information, please refer to the Operating Instructions and the additional documentation on the CD-ROM provided.

These Brief Operating Instructions are not intended to replace the Operating Instructions provided in the scope of supply.

The complete device documentation consists of:

- these Brief Operating Instructions
- Approvals and safety certificates
- a CD-ROM with:
 - the Operating Instructions
 - Technical Information

KA01051F/00/EN/13.10
71120300

Endress+Hauser 

People for Process Automation

Table of contents

1	Safety instructions	3
1.1	Designated use	3
1.2	Installation, commissioning and operation	3
1.3	Operational safety and process safety	3
1.4	Return	3
1.5	Safety icons	4
2	Mounting	5
2.1	Incoming acceptance, transport, storage	5
2.2	Installation	6
2.3	Post-installation check	9
3	Wiring	10
3.1	Wiring in F12/F23 housing	10
3.2	Wiring in T12 housing	11
3.3	Terminal assignment	11
3.4	Connecting the measuring unit	12
3.5	Screening/potential matching	13
3.6	Degree of protection	13
3.7	Post-connection check	13
4	Operation	14
4.1	General structure of the operating menu	14
4.2	Display and operating elements	15
5	Commissioning	18
5.1	Function check	18
5.2	Switching on the measuring device	18
5.3	Overview Basic Setup	19
5.4	Basic Setup with the device display	21
5.5	Envelope curve with device display	29

1 Safety instructions

1.1 Designated use

The Levelflex M is a compact level transmitter for the continuous measurement of solids and liquids, measuring principle: Guided Level Radar / TDR: **T**ime **D**omain **R**eflectometry.

1.2 Installation, commissioning and operation

- The device must only be installed, connected, commissioned and maintained by qualified and authorized specialists (e.g. electrical technicians) in full compliance with the instructions in this manual, the applicable norms, legal regulations and certificates (depending on the application).
- The specialist must have read and understood this manual and must follow the instructions it contains. If you are unclear on anything in these Brief Operating Instructions, you must read the Operating Instructions (on the CD-ROM). The Operating Instructions provide detailed information on the device/measuring system.
- The device may only be modified or repaired if such work is expressly permitted in the Operating Instructions (→ see CD-ROM).
- If faults cannot be rectified, the device must be taken out of service and secured against unintentional commissioning.
- Do not operate damaged devices. Mark them as defective.



1.3 Operational safety and process safety

- Alternative monitoring measures must be taken to ensure operational safety and process safety during configuration, testing and maintenance work on the device.
- The device is safely built and tested according to state-of-the-art technology and has left the factory in perfect condition as regards technical safety. The applicable regulations and European standards have been taken into account.
- Pay particular attention to the technical data on the nameplate.
- If the device is to be installed in an explosion hazardous area, then the specifications in the certificate as well as all national and local regulations must be observed. The device is accompanied by separate "Ex documentation", which is an integral part of this Operating Instructions. The installation regulations, connection values and Safety Instructions listed in this Ex document must be observed. The documentation number of the related Safety Instructions is also indicated.
- If using devices for applications with safety integrity level, the separate manual on functional safety must be observed thoroughly (→ see CD-ROM).

1.4 Return

Follow the instructions on returning the device as outlined in the Operating Instructions on the CD-ROM provided.

1.5 Safety icons

Symbol	Meaning
	Warning! A warning highlights actions or procedures which, if not performed correctly, will lead to personal injury, a safety hazard or destruction of the device.
	Caution! Caution highlights actions or procedures which, if not performed correctly, may lead to personal injury or incorrect functioning of the device.
	Note! A note highlights actions or procedures which, if not performed correctly, may indirectly affect operation or may lead to an device response which is not planned.

2 Mounting

2.1 Incoming acceptance, transport, storage

2.1.1 Incoming acceptance

Check the packing and contents for any signs of damage. Check the shipment, make sure nothing is missing and that the scope of supply matches your order.

2.1.2 Transport



Caution!

Follow the safety instructions and transport conditions for device of more than 18 kg. Do not lift the measuring device by its probe rod in order to transport it.

2.1.3 Storage

Pack the measuring device so that is protected against impacts for storage and transport. The original packing material provides the optimum protection for this. The permissible storage temperature is -40 °C to $+80\text{ °C}$.

2.2 Installation

2.2.1 Mounting kit

For the mounting, you will require the following tool:

- The tool for flange mounting
- 4 mm (0.1") Allen wrench for turning the housing

2.2.2 Minimum distance between the probe and the tank wall

Any distance from the wall is allowed as long as the probe does not come into contact with the tank wall.



Note!

- When installing in plastic tanks, there should be no metal parts or movement of people outside the tank at a distance of 300mm from the probe.
- Fouling or high-viscosity media should not create bridges to the wall.

2.2.3 Type of probe installation

- When installing in plastic tanks, the nozzle must have at least DN50 (2"). The appropriate flange must be used as the process connection.
- For nozzles up to 450 mm high, select the length of the centering rod appropriate for the nozzle height when using rope probes.
- Use spring washers (1) (see Figure).



Note!

It is recommended to retighten the securing screws at regular intervals, depending on the process temperature and pressure. Recommended torque: 60 to 100 Nm.

- After mounting, the housing can be turned 350° to make it easier to access the display and the connection compartment.

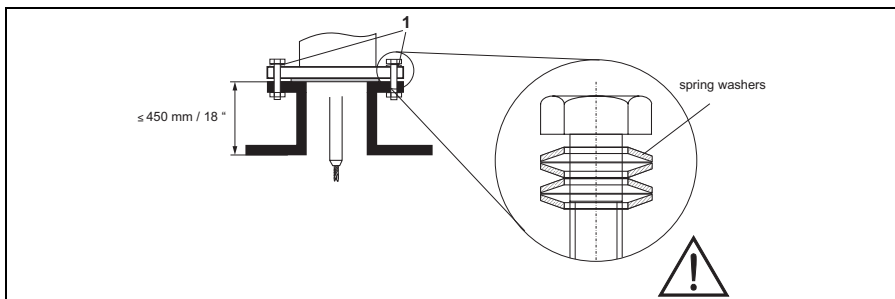

L00-FMP41Cxx-17-00-00-en-005



Note!

The PTFE plating of the FMP41C is used for sealing to the process. Usually no other sealing is necessary.

2.2.4 Notes on special mounting situations

Installation at an angle

- For mechanical reasons, rod probes should be installed as vertically as possible.
- With inclined installations the probe length has to be adjusted in dependence to the installation angle.
 - Up to 1 m = 30°
 - Up to 2 m = 10°
 - Up to 4 m = 5°

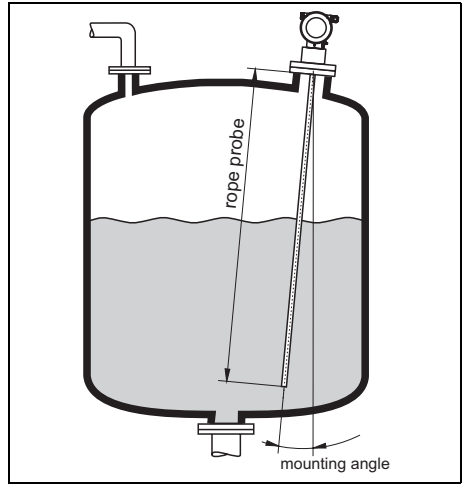

L00-FMP41c17-00-00-en-048

2.2.5 Special information on interface measurement

Installation in horizontal cylindrical, upright and underground tanks

- Use coax probes or rod probes in the bypass/stilling well. A segmented probe is available as a special version for longer measuring ranges.
- Any distance from the wall is possible for coax probes or rod probes in the stilling well. In the case of rod probes, it must be ensured that the probe does not come into contact with the wall.

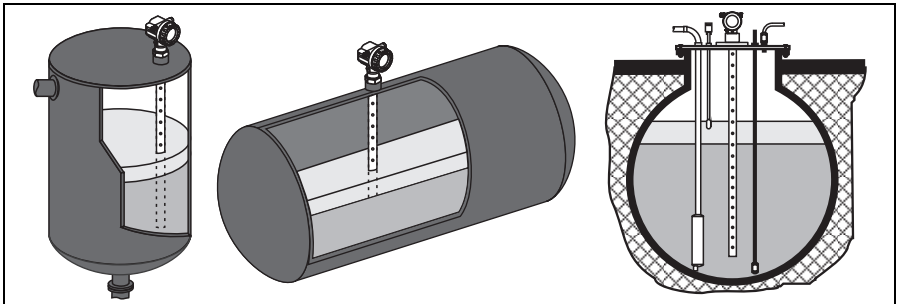

L00-FMP41c17-00-00-xx-002.eps

Installation in stilling well or bypass

- A rod probe can be used for pipe diameters bigger than 40 mm.
- Rod probe installation can take place up to a diameter size of 100 mm. In the event of larger diameters, a coax probe is recommended.
- Welded joints that protrude up to approx. 5 mm inwards do not affect the measurement.
- The pipe may not exhibit any steps in diameter.
- If a rod probe is used, the probe length must be 100 mm longer than the lower disposal.
- In the case of rod probes, it must be ensured that the probe does not come into contact with the wall. If necessary, use a centering disk at the end of the probe.



Note!

A plastic centering disk has to be used for interface measurement (see Operating Instruction on the CD-ROM).

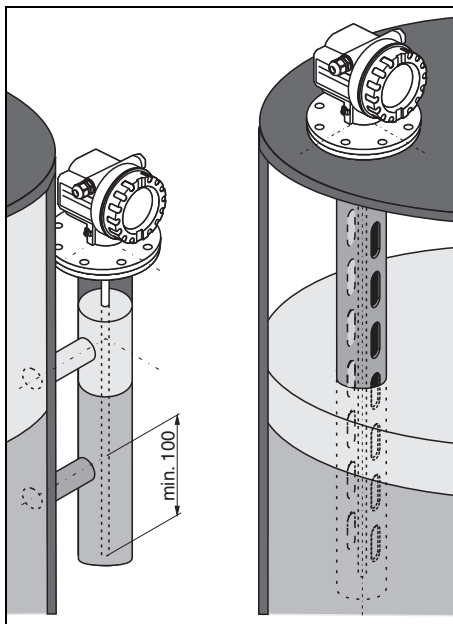

L00-FMP41cx-17-00-00-xx-003



Note!

Rope and rod probes can only be freely installed in the tank under certain circumstances - please contact your Endress+Hauser office.

2.2.6 Turn housing

After mounting, the housing can be turned 350° in order to simplify access to the display and the terminal compartment. Proceed as follows to turn the housing to the required position:

- Undo the fixing screws (1)
- Turn the housing (2) in the required direction
- Tighten up the fixing screws (1)

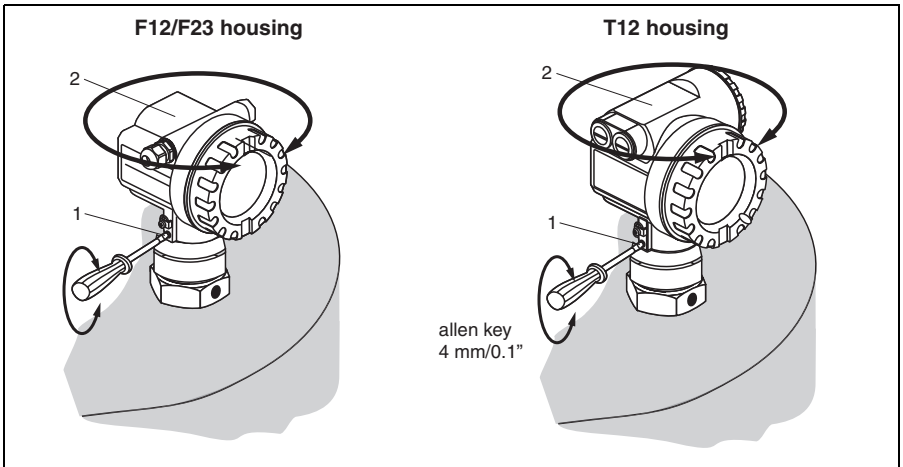

L00-FMP4xxxx-17-00-00-en-028

2.3 Post-installation check

After the measuring device has been installed, perform the following checks:

- Is the measuring device damaged (visual check) ?
- Does the measuring device correspond to the measuring point specifications such as process temperature/pressure, ambient temperature, measuring range, etc.?
- Are the measuring point number and labeling correct (visual check) ?
- Is the measuring device adequately protected against rain and direct sunlight (see Chapter "Accessories" in the Operating Instructions on the CD-ROM) ?

3 Wiring



Warning!

When using the measuring device in hazardous areas, installation must comply with the corresponding national standards and regulations and the Safety Instructions or Installation or Control Drawings.



Caution!

Before connection please note the following:

- The power supply must be identical to the data on the nameplate.
- Switch off power supply before connecting up the device.
- A standard installation cable is sufficient if only the analogue signal is used.
- Use a screened cable when working with a superimposed communications signal (HART).

3.1 Wiring in F12/F23 housing

1. Unscrew housing cover (1).
2. Remove any display (2) if fitted.
3. Remove cover plate from terminal compartment (3).
4. Pull out terminal module (4) slightly using "pulling loop".
5. Insert cable (5) through gland (6).
6. Make connection (see terminal assignment).
7. Re-insert terminal module (4).
8. Tighten cable gland (6).
Max. torque 10 to 12 Nm!
9. Tighten screws on cover plate (3).
10. Insert display (2) if fitted.
11. Screw on housing cover (1).
12. Switch on power supply.

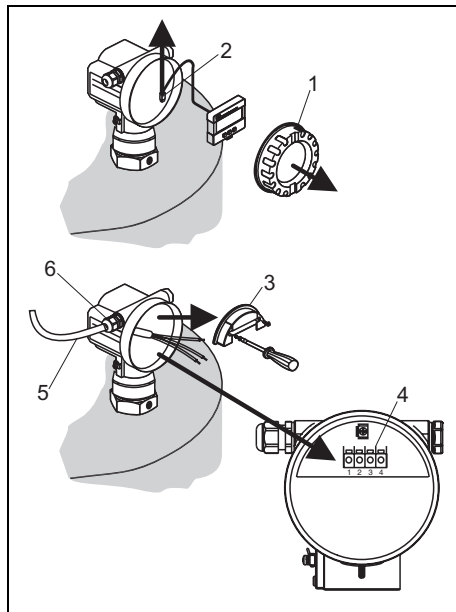

100-FMP40xxx-04-00-00-xx-001

3.2 Wiring in T12 housing

1. Unscrew housing cover (1).
2. Insert cable (2) through gland (3).
3. Connect cable screen to the grounding terminal (4) within the terminal compartment.
4. Make connection (see terminal assignment).
5. Tighten cable gland (6).
6. Screw on housing cover (1).
7. Switch on power supply.

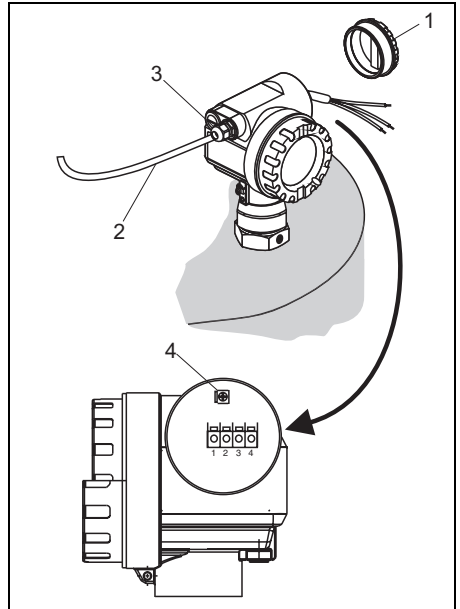

L00-FMP40xxxx-04-00-00-xx-002

3.3 Terminal assignment

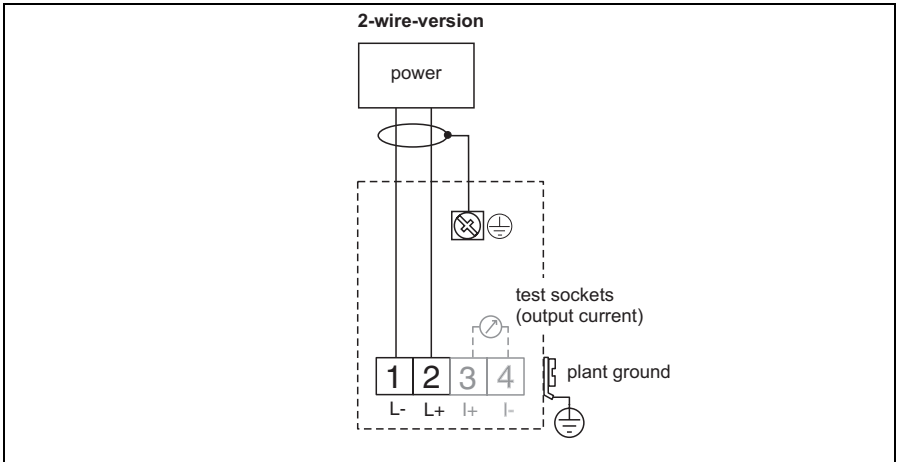

L00-FMP40xxxx-04-00-00-en-009

3.4 Connecting the measuring unit

Load HART

Minimum load for Hart communication: 250 Ω

Ground connection

It is necessary to make a good ground connection to the ground terminal on the outside of the housing, in order to achieve EMC security.

Cable entry

- Cable gland: M20x1.5
- Cable entry: G $\frac{1}{2}$ or $\frac{1}{2}$ NPT

Terminals

For wire cross-sections of 0.5...2.5 mm²

Supply voltage

The following values are the voltages across the terminals directly at the device:

Communication	Current consumption	Terminal voltage
HART	4 mA	16 V to 36 V
	20 mA	7.5 V to 36 V
Fixed current, adjustable e.g. for solar power operation (measured value transferred at HART)	11 mA	10 V to 36 V
Fixed current for HART Multidrop mode	4 mA ¹⁾	16 V to 36 V

1) Start up current 11 mA

HART residual ripple, 2-wire: $U_{ss} \leq 200$ mV

Power consumption

Min. 60 mW, max. 900 mW

Current consumption

3.6 to 22 mA for HART-Multidrop: start up current is 11 mA.

Overvoltage protection

If the measuring device is used for the level measurement in flammable liquids which requires the use of an overvoltage protection according to EN/IEC 60079-14 or EN/IEC 60060-1 (10 kA, Puls 8/20 μ s) it has to be ensured that

- the measuring device with integrated overvoltage protection with gas discharge tubes within the T12-enclosure is used, refer to "Ordering structure", in the Operating instructions on CD-ROM **or**
- this protection is achieved by the use of other appropriate measures (external protection devices e.g. HAW562Z).

3.5 Screening/potential matching

- You achieve optimum screening against disturbances if the screening is connected on both sides (in the cabinet and on the device). If you have to reckon with potential equalisation currents in the plant, only earth screening on one side, preferably at the transmitter.
- When using in hazardous areas, you must observe the applicable regulations and the separate Ex documentation.

3.6 Degree of protection

- with closed housing tested according to:
 - IP68, NEMA6P (24 h at 1.83 m under water surface)
 - IP66, NEMA4X
- with open housing: IP20, NEMA1 (also ingress protection of the display)

3.7 Post-connection check

After wiring the measuring device, perform the following checks:

- Is the terminal allocation correct (→  11)?
- Is the cable gland tight?
- Is the housing cover screwed tight?
- If auxiliary power is available:
Is the device ready for operation and is the liquid crystal display visible?

4 Operation

4.1 General structure of the operating menu

The operating menu is made up of two levels:

- **Function groups (00, 01, 03, ..., 0C, 0D):**

The individual operating options of the device are split up roughly into different function groups. The function groups that are available include, e.g.: **"basic setup"**, **"safety settings.."**, **"output"**, **"display"**, etc.

- **Functions (001, 002, 003, ..., 0D8, 0D9):**

Each function group consists of one or more functions. The functions perform the actual operation or parameterisation of the device. Numerical values can be entered here and parameters can be selected and saved. The available functions of the **"basic setup" (00)** function group include, e.g.: **"tank properties" (002)**, **"medium property" (003)**, **"process cond." (004)**, **"empty calibr." (005)**, etc.

If, for example, the application of the device is to be changed, carry out the following procedure:

1. Select the **"basic setup" (00)** function group
2. Select the **"tank properties" (002)** function (where the existing tank shape is selected).

4.1.1 Identifying the functions

For simple orientation within the function menus, for each function a position is shown on the display.

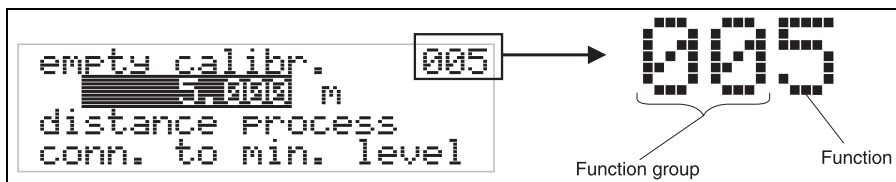

L00-FMRxxxxx-07-00-00-de-005

The first two digits identify the function group:

- **basic setup** **00**
- **safety settings** **01**
- **linearisation** **04**

...

The third digit numbers the individual functions within the function group:

- | | | | | |
|----------------------|-----------|---|----------------------------|------------|
| ■ basic setup | 00 | → | ■ tank properties | 002 |
| | | | ■ medium properties | 003 |
| | | | ■ process cond. | 004 |
| | | | ... | |

Here after the position is always given in brackets (e.g. "**tank properties**" (002)) after the described function.

4.2 Display and operating elements

4.2.1 Liquid crystal display (LCD)

Four lines with 20 characters each. Display contrast adjustable through key combination.

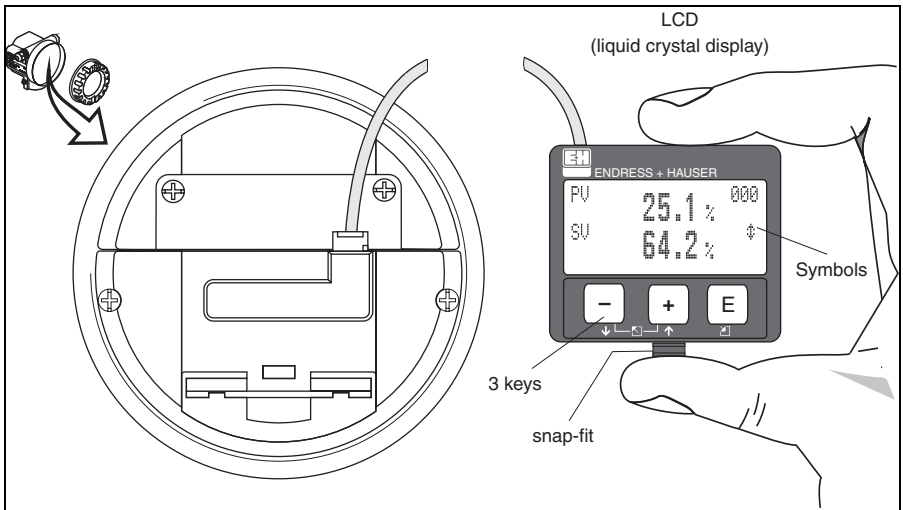

100-fmp4xtzx-07-00-00-en-001

The VU331 LCD display can be removed to ease operation by simply pressing the snap-fit (see graphic above). It is connected to the device by means of a 500 mm cable.

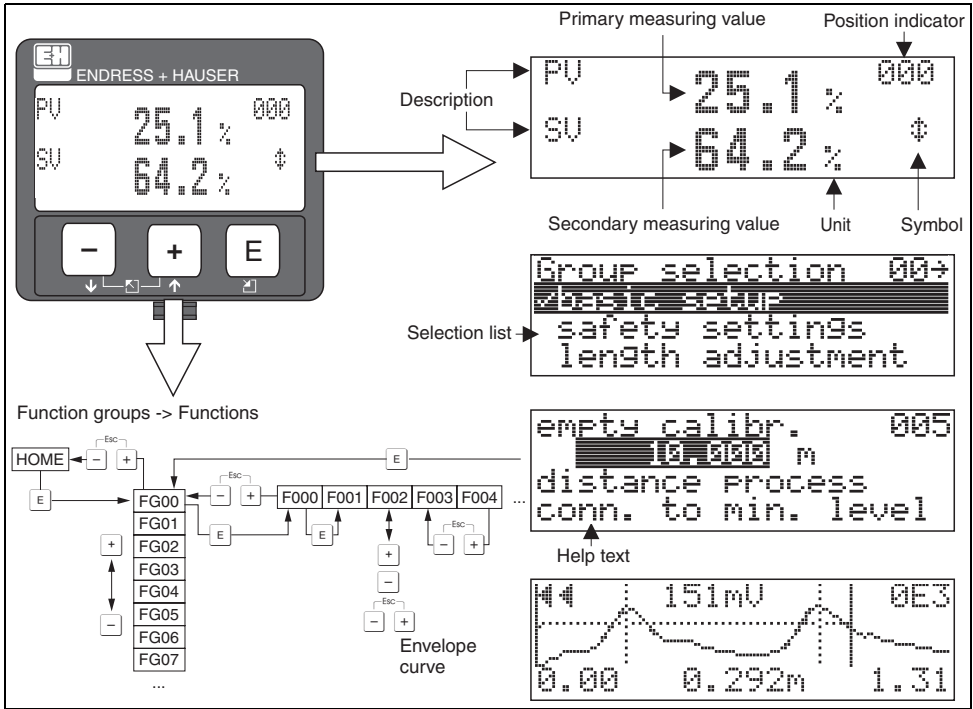

4.2.2 Display



L00-FMRxxxxx-07-00-00-en-007

4.2.3 Display symbols















The following table describes the symbols that appear on the liquid crystal display:

Symbol	Meaning
	ALARM_SYMBOL This alarm symbol appears when the device is in an alarm state. If the symbol flashes, this indicates a warning.
	LOCK_SYMBOL This lock symbol appears when the device is locked, i.e. if no input is possible.
	COM_SYMBOL This communication symbol appears when a data transmission via e.g. HART, PROFIBUS PA or FOUNDATION Fieldbus is in progress.

4.2.4 Key assignment

The operating elements are located inside the housing and are accessible for operation by opening the lid of the housing.

Function of the keys

Key(s)	Meaning
 or 	Navigate upwards in the selection list. Edit numeric value within a function.
 or 	Navigate downwards in the selection list. Edit numeric value within a function.
 or 	Navigate to the left within a function group.
	Navigate to the right within a function group, confirmation.
 and  or  and 	Contrast settings of the LCD.
 and  and 	Hardware lock / unlock After a hardware lock, an operation of the device via display or communication is not possible! The hardware can only be unlocked via the display. An unlock parameter must be entered to do so.

5 Commissioning

5.1 Function check

Make sure that all final checks have been completed before you start up your measuring point:

- Checklist "Post-installation check", → 9.
- Checklist "Post-connection check", → 13.

5.2 Switching on the measuring device

When the device is switched on for the first time, the following messages appear in a sequence of 5 s on the display: software version, communication protocol and language selection.

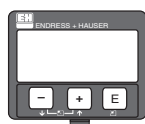

```

language 092
English
Deutsch
Français
  
```

Select the language
(this message appears the first time the device is switched on)



```

distance unit 005
m
ft
mm
  
```

Select the basic unit
(this message appears the first time the device is switched on)



```

PV 25.1 % 000
SV 64.2 % 0
  
```

The current measured value is displayed



```

Group selection 003
basic setup
safety settings
linearisation
  
```

After is pressed, you reach the group selection

This selection enables you to perform the basic setup

5.3 Overview Basic Setup

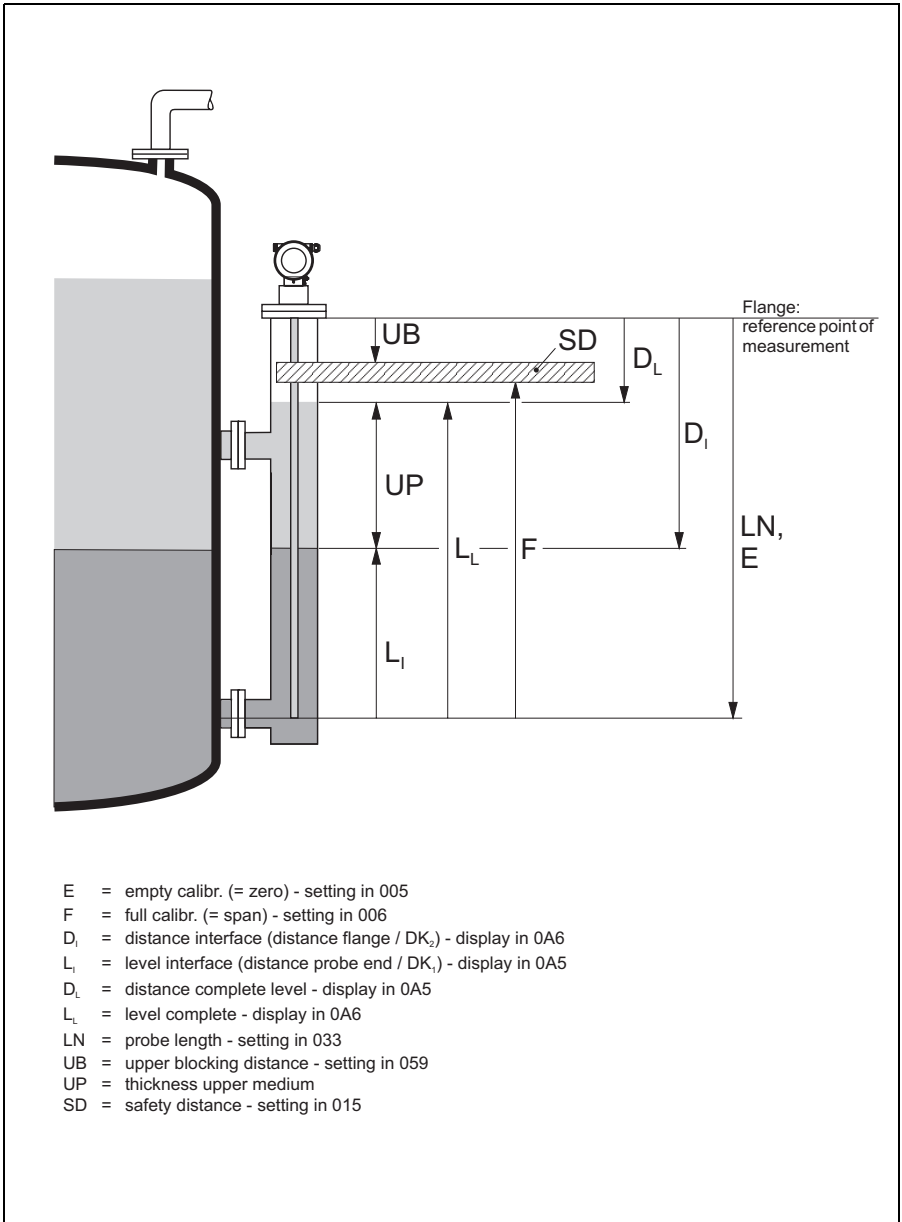

- E = empty calibr. (= zero) - setting in 005
- F = full calibr. (= span) - setting in 006
- DI = distance interface (distance flange / DK₂) - display in 0A6
- LI = level interface (distance probe end / DK₁) - display in 0A5
- DL = distance complete level - display in 0A5
- LI = level complete - display in 0A6
- LN = probe length - setting in 033
- UB = upper blocking distance - setting in 059
- UP = thickness upper medium
- SD = safety distance - setting in 015

L00-FMP4xxxx-19-00-00-de-040

 **Caution!**





The basic setup is sufficient for successful commissioning in most applications.

The Levelflex is precalibrated at the factory to the probe length ordered so that in most cases only the application parameters that automatically adapt the device to the measuring conditions need to be entered. For models with a current output, the factory adjustment for zero point "E" and span "F" is 4 mA and 20 mA. For digital outputs and the display module, the factory adjustment for zero point "E" and span "F" is 0 % and 100 %.

A linearization function with a maximum of 32 points, which is based on a table entered manually or semi-automatically, can be activated on site or via remote operation. This function makes it possible to convert the level to volume and mass units and has a uniform effect on the interface and the total level.

Complex measuring operations necessitate additional functions that the user can use to customize the Levelflex as necessary to suit his specific requirements. The functions available to do this are described in detail in BA00366F/00/EN.

Comply with the following instructions when configuring the functions in the "**basic setup**" (00):

- Select the functions, →  14.
- Certain functions (e.g. starting an interference echo mapping (053)) prompt you to confirm your data entries. Press  or  to select "**YES**" and press  to confirm. The function is now started.
- If you do not press a key during a configurable time period (→ function group "**Display (09)**") an automatic return is made to the home position (measured value display).

 **Note!**

- The device continues to measure while data entry is in progress, i.e. the current measured values are output via the signal outputs in the normal way.
- If the envelope curve mode is active on the display, the measured values are updated in a slower cycle time. Thus, it is advisable to leave the envelope curve mode after the measuring point has been optimized.
- If the power supply fails, all preset and configured values remain safely stored in the EEPROM.
- All functions are described in detail, as is the overview of the operating menu itself, in "**BA00366F - Description of Instrument Functions**" on the enclosed CD-ROM.

5.4 Basic Setup with the device display

5.4.1 Function "measured value" (000)



This function displays the current measured value in the selected unit (see "**Customer unit**" (042) function). The number of digits after the decimal point can be selected in the "**No. of Decimals**" (095) function.

The standard settings for PV and SV assignment are as follows:

PV corresponds to the interface layer; SV = total level

5.4.2 Function group "basic setup" (00)

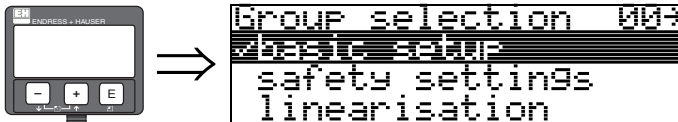

5.4.3 Function "tank properties" (002)



This function is used to select the tank properties. Depending on the settings, the system searches for one (fully flooded) echo or 2 (partially filled) echoes

Selection:

- Partially Filled
- Fully flooded

Partially Filled

The system searches for 2 signals in the measuring range. The upper signal is assigned to the total level and the lower signal to the level of the interface layer. The difference between the two levels corresponds to the thickness of the upper medium (upper phase).

Fully Flooded

The biggest signal in the measuring range is evaluated. If the signal for the total level is within the upper blocking distance, the signal detected corresponds to the level of the interface layer. If an echo is not found, echo loss is detected.



Note!

- If "fully flooded" is selected, it is absolutely essential that the upper signal for the total level is within the upper blocking distance so that it is not evaluated incorrectly. The setting for the upper blocking distance is an integral part of the basic setup if "fully flooded" is selected.
- A change in the total level when "fully flooded" is selected impacts the accuracy

5.4.4 Function "Process Propert." (004)

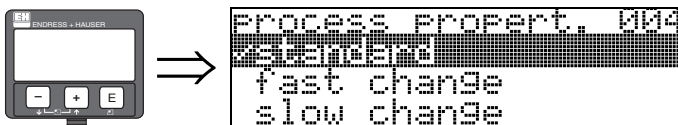

Use this function to adapt the device reaction to the filling speed in the tank. The setting influences an intelligent filter and affects the total level and interface layer level in the same way.

Options:

- **Standard**
- Fast change
- Slow change
- Test: no Filter

Options:	Standard	Fast Change	Slow Change	Test: No Filter
Application:	For all normal applications with low to medium filling speeds and sufficiently large tanks.	Small tanks, primarily with liquids, at high filling speeds.	Applications with slow to medium filling speed.	Shortest reaction time: <ul style="list-style-type: none"> ■ For test purposes ■ Measurement in small tanks at high filling speeds, if "Fast Change" setting is too slow.
2-wire electronics:	Totzeit: 4 s Anstiegszeit: 18 s	Totzeit: 2 s Anstiegszeit: 5 s	Totzeit: 6 s Anstiegszeit: 40 s	Totzeit: 1 s Anstiegszeit: 0 s

5.4.5 Function "empty calibr." (005)



This function is used to enter the distance from the flange (reference point of the measurement) to the minimum level (= zero).

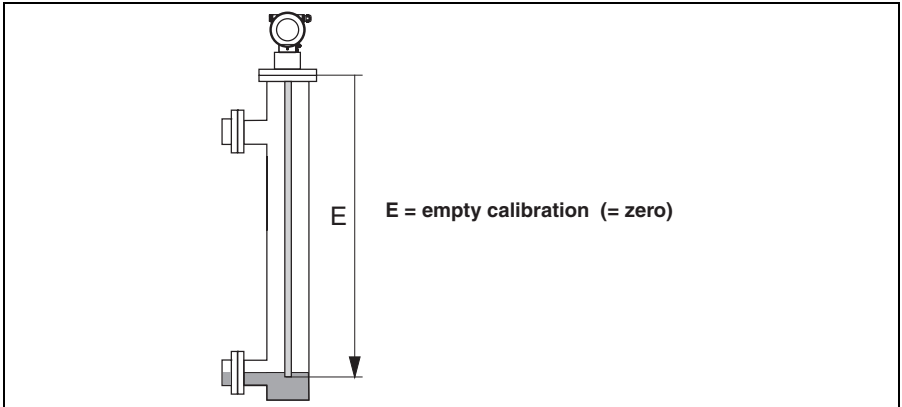

100-FMP41Clxx-14-00-06-en-001

5.4.6 Function "full calibr." (006)



This function is used to enter the distance from the minimum level to the maximum level (= span).

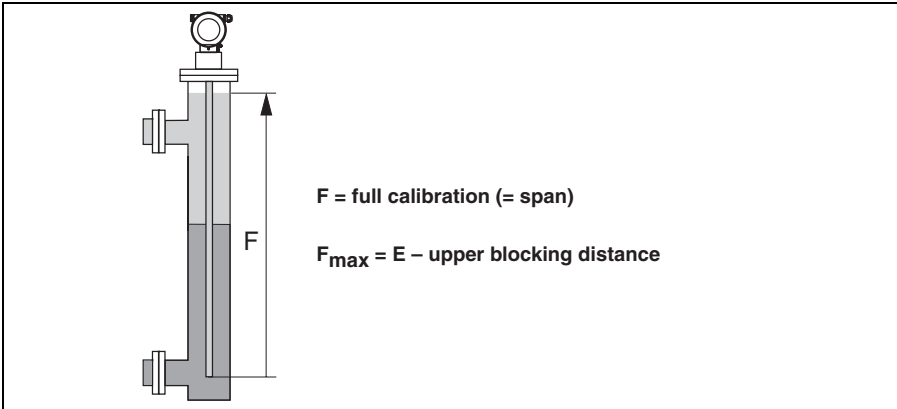

L00-FMP41 C1x-14-00-06-en-002



Note!

The useful measuring range is between the upper blocking distance and the probe end. The values for the empty distance "E" and span "F" can be set independently of the blocking distance.

5.4.7 Function "Upper Block. Dist" (059)

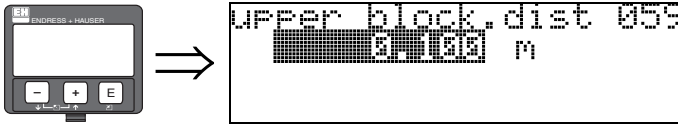

For rod and rope probes with lengths of up to 8 m, the upper blocking distance is preset to 0.2 m on delivery.

5.4.8 Blocking distances and measuring range depending on probe type

At the lower end of the probe, accurate measuring is not possible, see section "Maximum measured error".

FMP41C	LN [m] min	LN [m] max	UB [m] min
Rod probe in bypass	0.3	4	0.1 ¹⁾

1) The blocking distances indicated are preset.

5.4.9 Maximum measured error

Typical data under reference operating conditions:
DIN EN 61298-2, percentage values in relation to the span.

Output:	digital	analog
Sum of non-linearity, non-repeatability and hysteresis	Level (level and interface electronics versions): Measuring range: – Up to 10 m: ±3 mm – >10 m: ±0.03 %	±0.06 %
	Interface (only "K" interface measurement electronics version) – Measuring range up to 10 m: ±10 mm If the thickness of the interface is <60 mm, the interface can no longer be differentiated from the overall level such that both output signals are identical.	
Offset/zero point	±4 mm	±0.03 %

If the reference conditions are not met, the offset/zero point arising from the mounting situation may be up to ±12 mm for rod probes. This additional offset/zero point can be compensated for by entering a correction (function "Offset" (057)) during commissioning.

In the area around the lower probe end, the following measured error occurs for the level measurement (level and interface electronics version):

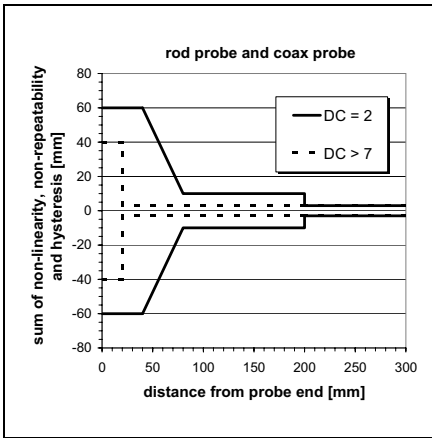

L00-FMP4xxxx-05-00-00-de-001

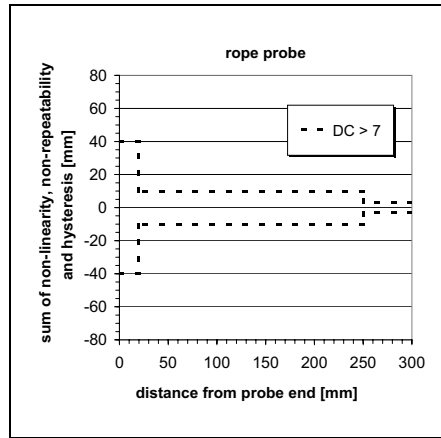

L00-FMP4xxxx-05-00-00-de-002

If the DC value is less than 7 for rope probes, then measurement is not possible in the area of the tensioning weight (0 to 250 mm from end of probe; lower blocking distance).

Deviating from this, the following measured error occurs for thin interface layers (only "K" interface measurement electronics version):

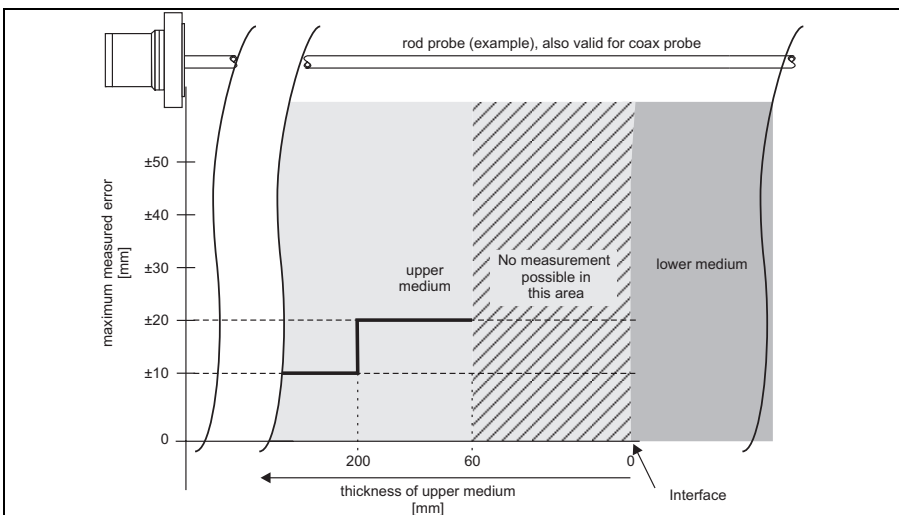

L00-FMP4xlxx-05-00-00-de-001

5.4.10 Function "Medium Property" (003)

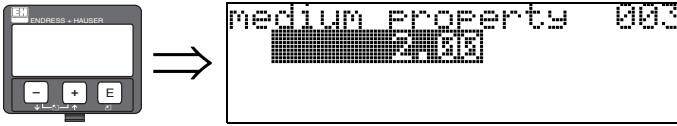

Use this function to enter the dielectric constant of the upper medium (upper phase).

Options:

- 2.00

The tables below split the DC values by product group. However, it is not sufficient to assume a typical value. For accurate interface measurement, it is necessary to determine the DC of the upper medium (upper phase) as accurately as possible and enter the value in this function. The DC of the upper medium must be known and constant. The DC can be determined with the aid of the DC manual SD00106F/00/EN. In addition, it is also possible to calculate the DC automatically in FieldCare if the interface thickness is available and known.

DC (ϵ_r)	Typical liquids	DC (ϵ_r)	Typical liquids
1.4 to 1.6	- Liquefied gases, e.g. N ₂ , CO ₂	2.5 to 4	- Benzene, styrene, toluene - Furan - Naphthalene
1.6 to 1.9	- Liquefied gas, e.g. propane - Solvent - Freon - Palm oil	4 to 7	- Chlorobenzene, chloroform - Cellulose spray - Isocyanate, aniline
1.9 to 2.5	- Mineral oils, fuels	> 7	- Aqueous solutions (DC ca. 80) - Alcohols - Ammonia



Note!

Due to the high diffusion rate of ammonia, it is recommended to use the FMP45 with gas-tight bushing for measurements in this medium.

5.4.11 Function "Distance/Measured Value" (008)

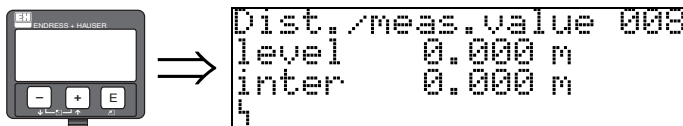

The measured distances from the reference point to the product level and the interface are shown. Check whether the values correspond to the actual distances. The following cases can occur:

- Distances correct → continue with group selection
- Distance to level incorrect → empty tank/bypass and perform mapping over the entire probe length (see BA00366F/00/EN "Description of Instrument Functions").
- Distance to interface incorrect → check entry for **"Medium Prop." (003)**.

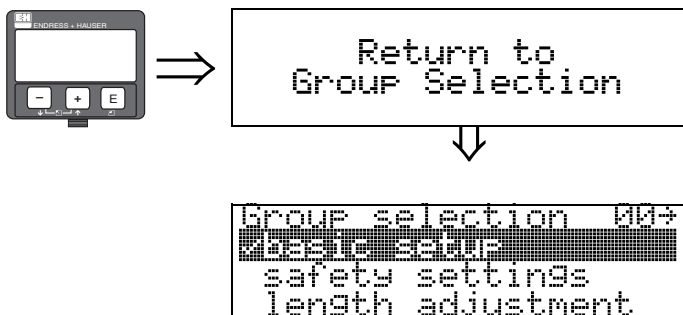

After 3 s, the following message appears

5.5 Envelope curve with device display

After the basic setup, an evaluation of the measurement with the aid of the envelope curve "envelope curve" (OE) function group) is recommended.

5.5.1 Function "plot settings" (OE1)

Here you can select which information is shown on the display:

- **envelope curve**
- subtracted signal
- mapping

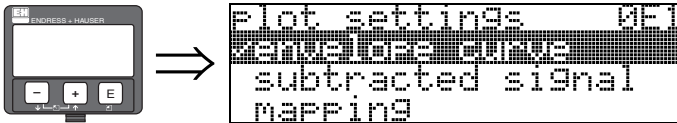

Note!

The interference echo suppression (map) are explained in BA00366F/00/EN "Description of Instrument Functions".

5.5.2 Function "recording curve" (OE2)

This function determines whether the envelope curve is read as

- **single curve** or
- cyclic



Note!

If the envelope curve mode is active on the display, the measured values are updated in a slower cycle time. Thus, it is advisable to leave the envelope curve mode after the measuring point has been optimised.

www.endress.com/worldwide

Endress+Hauser 

People for Process Automation

KA01051F/00/EN/13.10
71120300
CCS/FM+SGML 6.0

