



Level



Pressure



Flow



Temperature



Liquid
Analysis



Registration



Systems
Components



Services



Solutions

Safety Instructions

Levelflex M

FMP40, FMP43, FMP45

PROFIBUS PA, FOUNDATION Fieldbus

Ex ia IIC T6...T1

NEPSI GYJ111018

XA00379F-C



en - Safety instructions for electrical apparatus for explosion-hazardous areas.

zh - 爆炸环境中电气仪表的安全指南。

Levelflex M

FMP40, FMP43, FMP45

english

PROFIBUS PA, FOUNDATION Fieldbus

**Associated
Documentation**

This document is an integral part of the following Operating Instructions:
PROFIBUS PA: BA243F/00 (FMP40), BA358F/00 (FMP43), BA280F/00 (FMP45)
FOUNDATION Fieldbus: BA244F/00 (FMP40), BA359F/00 (FMP43), BA281F/00 (FMP45)
The Operating Instructions which are supplied and correspond to the device type apply.

Designation

Explanation of the labelling and type of protection can be found in the explosion protection brochure.

Designation of explosion protection**Ex ia IIC T6...T1**

T12 - OVP

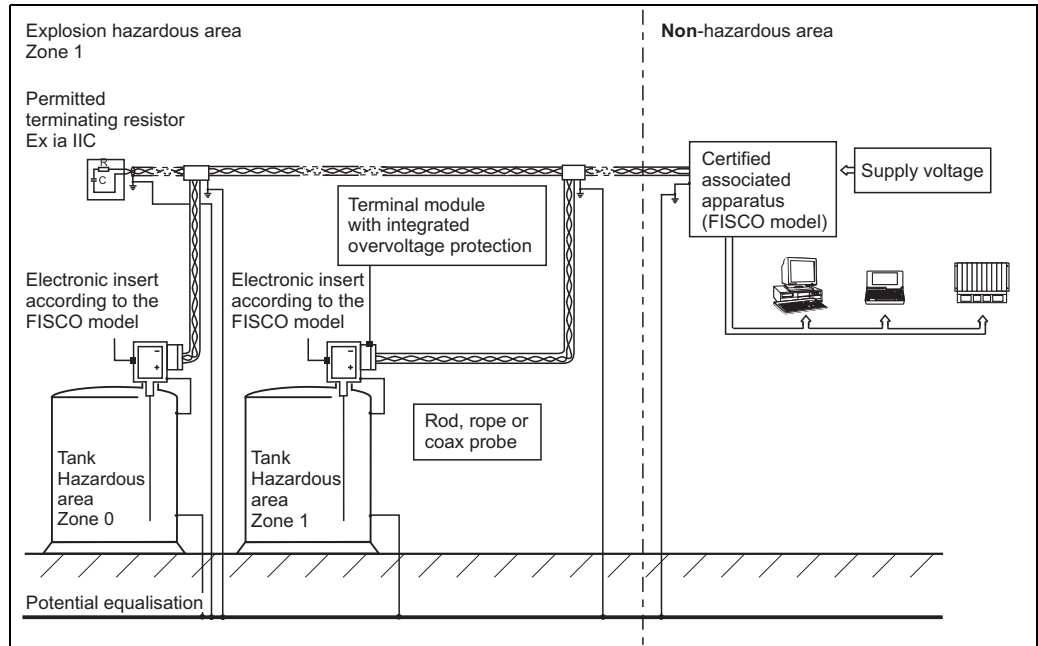

Fig. 1

F12, F23

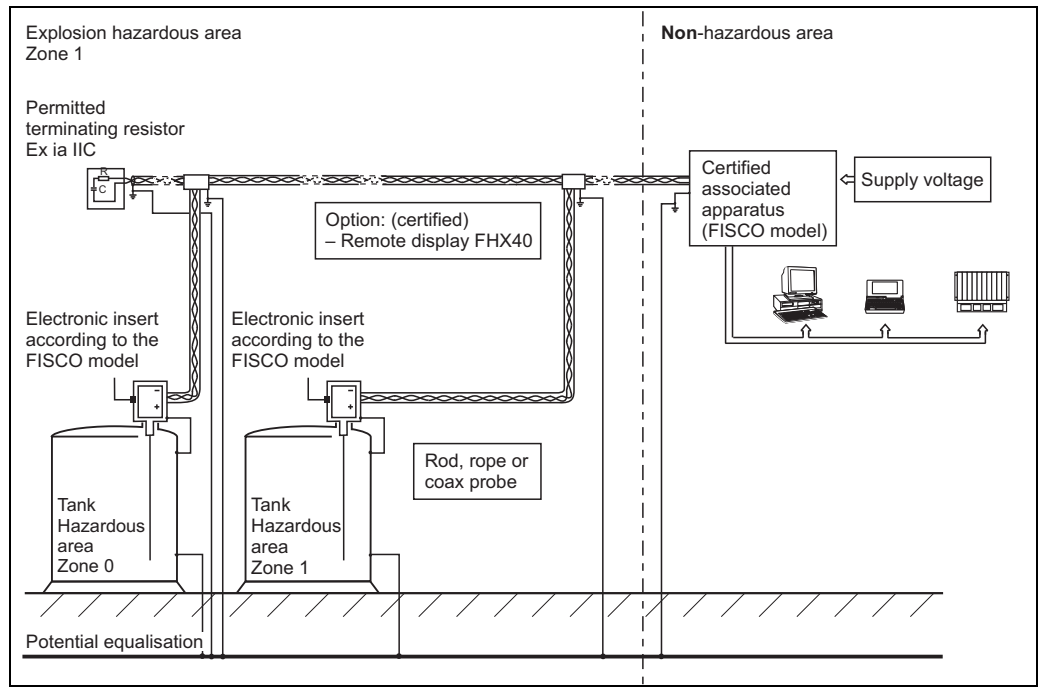

Fig. 2

T12 - OVP, F12, F23

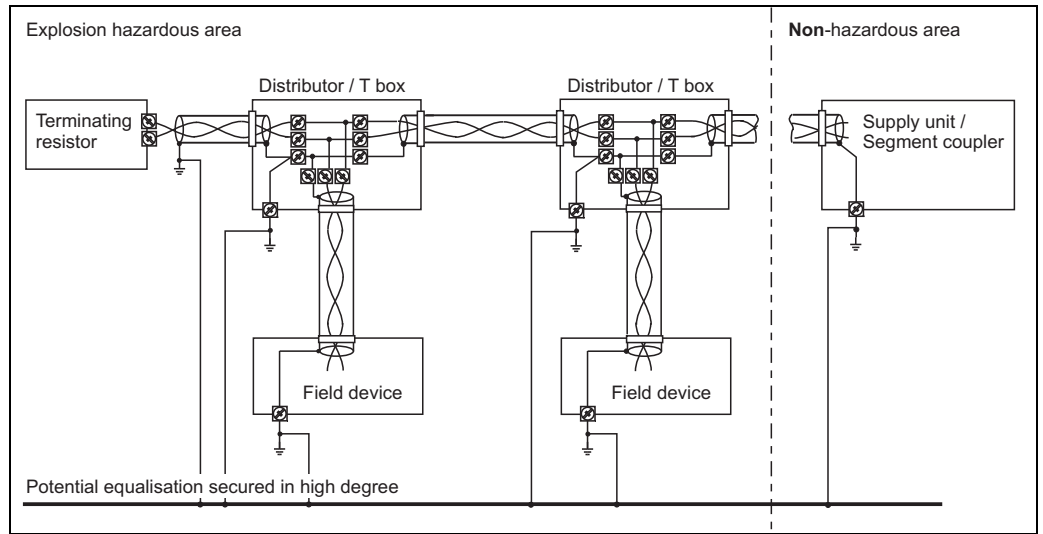

Fig. 3

Version 1

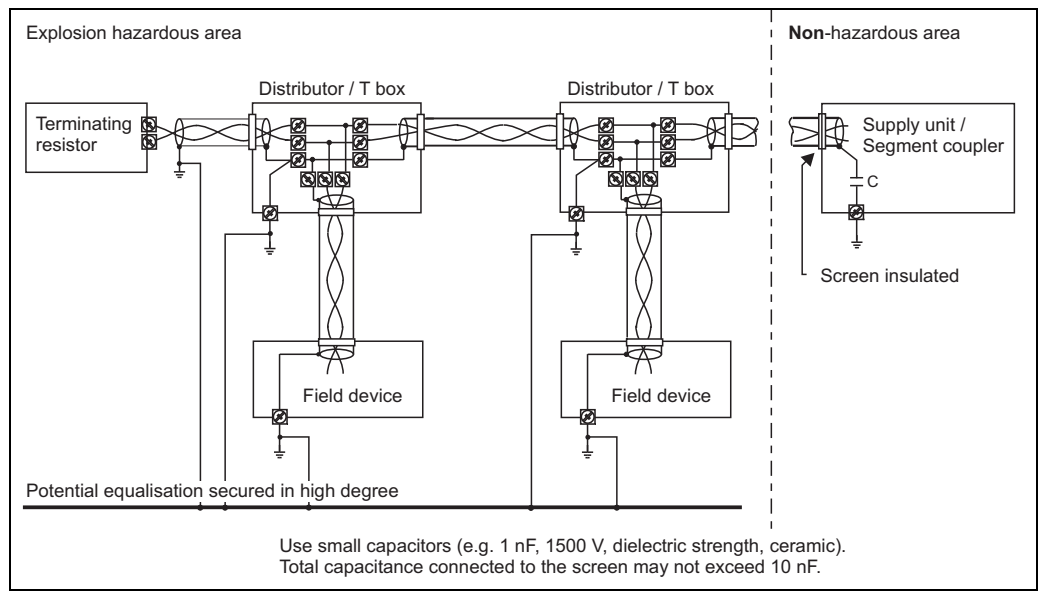

Fig. 4

Version 2

Certified associated apparatus	T12 - OVP	Uo ≤ 17.5 V Io ≤ 273 mA Po ≤ 1.2 W	or	Uo ≤ 24 V Io ≤ 250 mA Po ≤ 1.2 W	PROFIBUS PA or FOUNDATION Fieldbus FICSCO model (reduced values) [Ex ia] IIC or [Ex ib] IIC
	F12, F23	Uo ≤ 17.5 V Io ≤ 500 mA Po ≤ 5.5 W	or	Uo ≤ 24 V Io ≤ 250 mA Po ≤ 1.2 W	PROFIBUS PA or FOUNDATION Fieldbus FICSCO model [Ex ia] IIC or [Ex ib] IIC

Application	Zone 0/1 or Zone 1	Probe in Zone 0 and housing in Zone 1 or probe and housing in Zone 1
Type of protection	Ex ia IIC T6...T1	
Max. working pressure	Dependent on the probe	
Process temperature	Dependent on the probe	

Housing	T12 - OVP aluminium coated (with integrated overvoltage protector)	-40 °C ≤ Tu ≤ +80 °C	Optionally with or without VU331 display and operating module
	F12 aluminium coated	-40 °C ≤ Tu ≤ +80 °C	Optionally with or without VU331 display and operating module
	F23 SS 316L	-40 °C ≤ Tu ≤ +80 °C	Optionally with or without VU331 display and operating module

F12, F23:

Option	Remote display, e.g. FHX40	NEPSI certified	Observe associated Safety Instructions
---------------	---------------------------------------	-----------------	--

**Safety instructions:
Installation**

- Install the device according to the manufacturer's instructions and any other valid standards and regulations.
- Do not operate the device outside the specified electrical, thermal and mechanical parameters.
- The external earth connection facility shall be connected reliably.
- For grounding the screen, see figure 3 and 4.
- The relationship between the permitted ambient temperature for the electronics housing, dependent on the range of application, and the temperature classes is shown in the tables (Tab. 1a FMP40, Tab. 1b FMP45).
- After aligning (rotating) the housing, retighten the fixing screw (see Operating Instructions).
- Continuous duty temperature of the cable ≥ Ta +5 K.
- Install the device to exclude any mechanical damage or friction during the application.
Pay particular attention to flow conditions and fittings.

T12 - OVP:

- The intrinsically safe input power circuit of the device is isolated from ground potential. The dielectric strength to earth is limited by 600 V electrode arresters.

F12, F23:

- The intrinsically safe input power circuit of the device is isolated from ground potential and has a dielectric strength of at least 500 Vrms with respect to it.

FMP43

- The device with separable probe in separated mode shall be closed by protective cover.

Zone 1 - Application

Tab. 1a **FMP40**

Housing T12 - OVP						
Temperature class with or without VU331 display	Maximum permitted medium temperature (process connection) Probe in Zone 1	Maximum permitted ambient temperature at the electronics housing (electronics housing in Zone 1) dependent on the medium temperature				
		With ¾" probe, compact	With ¾" probe and remote electronics / spacer tube	With 1½" probe, compact	With 1½" probe and remote electronics / spacer tube	With remote electronics / spacer hose
T6	+ 80 °C + 60 °C	55 °C 60 °C	55 °C 60 °C	55 °C 60 °C	55 °C 60 °C	60 °C 60 °C
T5	+ 95 °C + 75 °C	70 °C 75 °C	70 °C 75 °C	70 °C 75 °C	70 °C 75 °C	75 °C 75 °C
T4	+130 °C + 80 °C	65 °C 80 °C	75 °C 80 °C	65 °C 80 °C	75 °C 80 °C	80 °C 80 °C
T3 (functional) *1, T2, T1	+150 °C + 80 °C	55 °C 80 °C	75 °C 80 °C	55 °C 80 °C	75 °C 80 °C	80 °C 80 °C

Note: permitted probe temperature range must be observed
 *1 functional = limited by maximum permitted probe temperature

Housing F12						
Temperature class with or without VU331 display	Maximum permitted medium temperature (process connection) Probe in Zone 1	Maximum permitted ambient temperature at the electronics housing (electronics housing in Zone 1) dependent on the medium temperature				
		With ¾" probe, compact	With ¾" probe and remote electronics / spacer tube	With 1½" probe, compact	With 1½" probe and remote electronics / spacer tube	With remote electronics / spacer hose
T6	+ 80 °C + 60 °C	55 °C 60 °C	55 °C 60 °C	55 °C 60 °C	55 °C 60 °C	60 °C 60 °C
T5	+ 95 °C + 75 °C	70 °C 75 °C	70 °C 75 °C	70 °C 75 °C	70 °C 75 °C	75 °C 75 °C
T4	+130 °C + 80 °C	70 °C 80 °C	75 °C 80 °C	70 °C 80 °C	75 °C 80 °C	80 °C 80 °C
T3 (functional) *1, T2, T1	+150 °C + 80 °C	65 °C 80 °C	75 °C 80 °C	70 °C 80 °C	75 °C 80 °C	80 °C 80 °C

Note: permitted probe temperature range must be observed
 *1 functional = limited by maximum permitted probe temperature

Housing F23						
Temperature class with or without VU331 display	Maximum permitted medium temperature (process connection) Probe in Zone 1	Maximum permitted ambient temperature at the electronics housing (electronics housing in Zone 1) dependent on the medium temperature				
		With ¾" probe, compact	With ¾" probe and remote electronics / spacer tube	With 1½" probe, compact	With 1½" probe and remote electronics / spacer tube	With remote electronics / spacer hose
T6	+ 80 °C + 60 °C	55 °C 60 °C	55 °C 60 °C	55 °C 60 °C	55 °C 60 °C	60 °C 60 °C
T5	+ 95 °C + 75 °C	70 °C 75 °C	70 °C 75 °C	70 °C 75 °C	70 °C 75 °C	75 °C 75 °C
T4	+130 °C + 80 °C	65 °C 80 °C	75 °C 80 °C	65 °C 80 °C	75 °C 80 °C	80 °C 80 °C
T3 (functional) * ¹ , T2, T1	+150 °C + 80 °C	55 °C 80 °C	75 °C 80 °C	55 °C 80 °C	75 °C 80 °C	80 °C 80 °C

Note: permitted probe temperature range must be observed

*¹ functional = limited by maximum permitted probe temperature

Tab. 1b **FMP43**

Housing T12 - OVP			
Temperature class with or without VU331 display	Maximum permitted medium temperature (process connection) Probe in Zone 1	Maximum permitted temperature at the electronics housing (electronics housing in Zone 1) dependent on the medium temperature	
		Compact or compact, detachable	Remote, cable, detachable
T6	+ 80 °C + 60 °C	55 °C 60 °C	60 °C 60 °C
T5	+ 95 °C + 75 °C	70 °C 75 °C	75 °C 75 °C
T4	+130 °C + 80 °C	70 °C 80 °C	80 °C 80 °C
T3, T2, T1 (functional) * ¹	+150 °C + 80 °C	65 °C 80 °C	80 °C 80 °C

Note: the applicable temperature of probe must be within their specified limits

*¹ functional = max. permissible process temperature

Housing F12			
Temperature class with or without VU331 display	Maximum permitted medium temperature (process connection) Probe in Zone 1	Maximum permitted temperature at the electronics housing (electronics housing in Zone 1) dependent on the medium temperature	
		Compact or compact, detachable	Remote, cable, detachable
T6	+ 80 °C + 60 °C	55 °C 60 °C	60 °C 60 °C
T5	+ 95 °C + 75 °C	70 °C 75 °C	75 °C 75 °C
T4	+130 °C + 80 °C	70 °C 80 °C	80 °C 80 °C
T3, T2, T1 (functional) * ¹	+150 °C + 80 °C	65 °C 80 °C	80 °C 80 °C

Note: the applicable temperature of probe must be within their specified limits

*¹ functional = max. permissible process temperature

Housing F23			
Temperature class with or without VU331 display	Maximum permitted medium temperature (process connection) Probe in Zone 1	Maximum permitted temperature at the electronics housing (electronics housing in Zone 1) dependent on the medium temperature	
		Compact or compact, detachable	Remote, cable, detachable
T6	+ 80 °C + 60 °C	55 °C 60 °C	60 °C 60 °C
T5	+ 95 °C + 75 °C	70 °C 75 °C	75 °C 75 °C
T4	+130 °C + 80 °C	65 °C 80 °C	80 °C 80 °C
T3, T2, T1 (functional)* ¹	+150 °C + 80 °C	55 °C 80 °C	80 °C 80 °C

Note: the applicable temperature of probe must be within their specified limits
 *¹ functional = max. permissible process temperature

Tab. 1c **FMP45**

Housing T12 - OVP				
Temperature class with or without VU331 display	Maximum permitted medium temperature (process connection) Probe in Zone 1	Maximum permitted ambient temperature at the electronics housing (electronics housing in Zone 1) dependent on the medium temperature		
		Type A, (XT version)	Type B (HT version)	With remote electronics / spacer hose
T6	+ 80 °C + 60 °C	58 °C 60 °C	59 °C 60 °C	60 °C 60 °C
T5	+ 95 °C + 75 °C	73 °C 75 °C	74 °C 75 °C	75 °C 75 °C
T4	+130 °C + 80 °C	76 °C 80 °C	78 °C 80 °C	80 °C 80 °C
T3 (functional) * ¹	+150 °C + 80 °C	74 °C 80 °C	74 °C 80 °C	80 °C 80 °C
T3	+195 °C + 80 °C	72 °C 80 °C	75 °C 80 °C	80 °C 80 °C
T2 (functional) * ¹	+250 °C + 80 °C	68 °C 80 °C	70 °C 80 °C	80 °C 80 °C
T2 (functional) * ¹	+290 °C + 80 °C	280 °C: 66 °C 80 °C	72 °C 80 °C	80 °C 80 °C
T1 (functional) * ¹	+400 °C + 80 °C	not allowed	67 °C 80 °C	80 °C 80 °C

Note: permitted probe temperature range must be observed
 *¹ functional = limited by maximum permitted probe temperature

Housing F12				
Temperature class with or without VU331 display	Maximum permitted medium temperature (process connection) Probe in Zone 1	Maximum permitted ambient temperature at the electronics housing (electronics housing in Zone 1) dependent on the medium temperature		
		Type A, (XT version)	Type B (HT version)	With remote electronics / spacer hose
T6	+ 80 °C + 60 °C	58 °C 60 °C	59 °C 60 °C	60 °C 60 °C
T5	+ 95 °C + 75 °C	73 °C 75 °C	74 °C 75 °C	75 °C 75 °C
T4	+130 °C + 80 °C	76 °C 80 °C	77 °C 80 °C	80 °C 80 °C
T3 (functional) * ¹	+150 °C + 80 °C	74 °C 80 °C	76 °C 80 °C	80 °C 80 °C
T3	+195 °C + 80 °C	72 °C 80 °C	75 °C 80 °C	80 °C 80 °C
T2 (functional) * ¹	+250 °C + 80 °C	69 °C 80 °C	73 °C 80 °C	80 °C 80 °C
T2 (functional) * ¹	+290 °C + 80 °C	280 °C: 67 °C 80 °C	71 °C 80 °C	80 °C 80 °C
T1 (functional) * ¹	+400 °C + 80 °C	not allowed	66 °C 80 °C	80 °C 80 °C

Note: permitted probe temperature range must be observed

*¹ functional = limited by maximum permitted probe temperature

Housing F23				
Temperature class with or without VU331 display	Maximum permitted medium temperature (process connection) Probe in Zone 1	Maximum permitted ambient temperature at the electronics housing (electronics housing in Zone 1) dependent on the medium temperature		
		Type A, (XT version)	Type B (HT version)	With remote electronics / spacer hose
T6	+ 80 °C + 60 °C	57 °C 60 °C	58 °C 60 °C	60 °C 60 °C
T5	+ 95 °C + 75 °C	72 °C 75 °C	73 °C 75 °C	75 °C 75 °C
T4	+130 °C + 80 °C	74 °C 80 °C	76 °C 80 °C	80 °C 80 °C
T3 (functional) * ¹	+150 °C + 80 °C	69 °C 80 °C	74 °C 80 °C	80 °C 80 °C
T3	+195 °C + 80 °C	66 °C 80 °C	70 °C 80 °C	80 °C 80 °C
T2 (functional) * ¹	+250 °C + 80 °C	60 °C 80 °C	66 °C 80 °C	80 °C 80 °C
T2 (functional) * ¹	+290 °C + 80 °C	280 °C: 56 °C 80 °C	63 °C 80 °C	80 °C 80 °C
T1 (functional) * ¹	+400 °C + 80 °C	not allowed	54 °C 80 °C	80 °C 80 °C

Note: permitted probe temperature range must be observed

*¹ functional = limited by maximum permitted probe temperature

- The type of protection changes as follows when the devices are connected to certified intrinsically safe circuits of Category Ex ib for Equipment Groups IIC and IIB: Ex ib IIC T6 and Ex ib IIB T6. Do not operate the probe in Zone 0 if the transmitter is connected to an intrinsically safe circuit of Category Ex ib.
- Changes in electrical and mechanical parts of the equipment could harm the type of explosion protection and are not allowed for the user.

Overvoltage protection

T12 - OVP:

- The integrated overvoltage protector meets the requirements as per IEC/EN 60079-14, Section 12.3
- FMP43: The version "separable, remote cable" may have additional measures.

F12, F23:

- On installations requiring overvoltage protection to comply with national regulations or standards, this device shall be installed using an overvoltage protector.

Tab. 2a

Power supply and signal circuit in protection type: intrinsic safety Ex ia IIC or IIB

Levelflex M with electronic insert PROFIBUS PA or FOUNDATION Fieldbus, Ex ia IIC (FISCO model)			
T12 - OVP (reduced values)	U _i = 17.5 V I _i = 273 mA P _i = 1.2 W	or	U _i = 24 V I _i = 250 mA P _i = 1.2 W
F12, F23	U _i = 17.5 V I _i = 500 mA P _i = 5.5 W	or	U _i = 24 V I _i = 250 mA P _i = 1.2 W
			Li = 10 µH Ci = 5 nF Leak current ≤ 50 µA

Tab. 2b

Power supply and signal circuit for remote display, e.g. FHX40, in protection type: intrinsic safety Ex ia IIC or IIB

F12, F23	U _o = 4.2 V I _o = 34 mA P _o = 36 mW	effective inner inductance effective inner capacitance characteristic curve	Li = negligible Ci = negligible linear	Co = 4 µF Lo = 5 mH
-----------------	--	---	--	------------------------

- The criteria for interconnection between the instrument and the associated apparatus is as below:
U_o ≤ U_i, I_o ≤ I_i, P_o ≤ P_i, Co ≥ Ci + Cc, Lo ≥ Li + Lc
Note: Cc and Lc represent the distributed capacitance and distributed inductance of cable.

**Safety instructions:
Zone 0**

- Only operate devices in potentially explosive vapour/air mixtures under atmospheric conditions *2:
-20 °C ≤ T ≤ +60 °C
0.8 bar ≤ p ≤ 1.1 bar
- If no potentially explosive mixtures are present, the transmitters may be operated under other atmospheric conditions in accordance with the manufacturer's specifications.
- Only install the devices in media for which the wetted materials have sufficient durability.
- Associated apparatus with galvanic isolation between the intrinsically safe and non-intrinsically safe circuits are preferred.
- For installation, use and maintenance of the device, users must also observe the requirements stated in the Operating Instructions and the standards:
 - GB50257-1996: "Code for construction and acceptance of electric device for explosion atmospheres and fire hazard electrical equipment installation engineering".
 - GB3836.13-1997: "Electrical apparatus for explosive gas atmospheres, Part 13: Repair and overhaul for apparatus used in explosive gas atmospheres".
 - GB3836.15-2000: "Electrical apparatus for explosive gas atmospheres, Part 15: Electrical installations in hazardous area (other than mines)".
 - GB3836.16-2006: "Electrical apparatus for explosive gas atmospheres, Part 16: Inspection and maintenance of electrical installation (other than mines)".

Zone 0 - ApplicationTab. 3a **FMP40**

T12 - OVP, F12, F23						
Temperature class with or without VU331 display	Maximum permitted medium temperature (process connection) Probe in Zone 0 *2	Maximum permitted ambient temperature at the electronics housing (electronics housing in Zone 1) dependent on the medium temperature				
		With ¾" probe, compact	With ¾" probe and remote electronics / spacer tube	With 1½" probe, compact	With 1½" probe and remote electronics / spacer tube	With remote electronics / spacer hose
T6	+60 °C	60 °C	60 °C	60 °C	60 °C	60 °C
T5	+60 °C	75 °C	75 °C	75 °C	75 °C	75 °C
T4, T3, T2, T1	+60 °C	80 °C	80 °C	80 °C	80 °C	80 °C

Tab. 3b **FMP43**

T12 - OVP			
Temperature class with or without VU331 display	Maximum permitted medium temperature (process connection) Probe in Zone 0 *2	Maximum permitted temperature at the electronics housing (electronics housing in Zone 1) dependent on the medium temperature	
		Compact or compact, detachable	Remote, cable, detachable
T6	+60 °C +60 °C	55 °C 60 °C	60 °C 60 °C
T5	+60 °C +60 °C	70 °C 75 °C	75 °C 75 °C
T4	+60 °C +60 °C	70 °C 80 °C	80 °C 80 °C
T3, T2, T1 (functional)*1	+60 °C +60 °C	65 °C 80 °C	80 °C 80 °C

Note: the applicable temperature of probe must be within their specified limits

*1 functional = max. permissible process temperature

F12, F23			
Temperature class with or without VU331 display	Maximum permitted medium temperature (process connection) Probe in Zone 0 *2	Maximum permitted temperature at the electronics housing (electronics housing in Zone 1) dependent on the medium temperature	
		Compact or compact, detachable	Remote, cable, detachable
T6	+60 °C	60 °C	60 °C
T5	+60 °C	75 °C	75 °C
T4	+60 °C	80 °C	80 °C
T3, T2, T1 (functional)*1	+60 °C	80 °C	80 °C

Note: the applicable temperature of probe must be within their specified limits

*1 functional = max. permissible process temperature

Tab. 3c **FMP45**

T12 - OVP, F12, F23				
Temperature class with or without VU331 display	Maximum permitted medium temperature (process connection) Probe in Zone 0 *2	Maximum permitted ambient temperature at the electronics housing (electronics housing in Zone 1) dependent on the medium temperature		
		Type A, (XT version)	Type B (HT version)	With remote electronics / spacer hose
T6	+60 °C	60 °C	60 °C	60 °C
T5	+60 °C	75 °C	75 °C	75 °C
T4, T3, T2, T1	+60 °C	80 °C	80 °C	80 °C

Levelflex M

FMP40, FMP43, FMP45

中文

PROFIBUS PA, FOUNDATION Fieldbus (基金会现场总线)

相关资料

本文档是下列操作手册的组成部分：

PROFIBUS PA：BA243F/00 (FMP40)、BA358F/00 (FMP43)、BA280F/00 (FMP45)

FOUNDATION Fieldbus (基金会现场总线)：BA244F/00 (FMP40)、BA359F/00 (FMP43)、BA281F/00 (FMP45)

根据用户订购仪表的具体型号所提供的相应操作手册。

名称

防爆标志和防护类型说明请查询防爆手册。

防爆代号

Ex ia IIC T6...T1

T12 - OVP



图 1

F12, F23

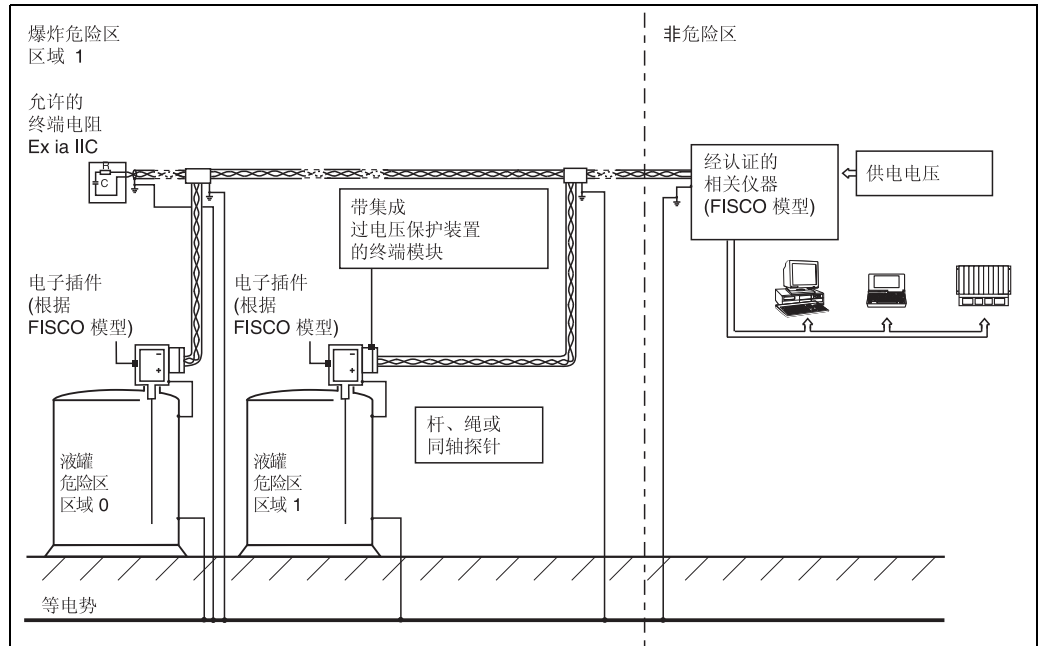

图 2

T12 - OVP, F12, F23



图 3
版本 1

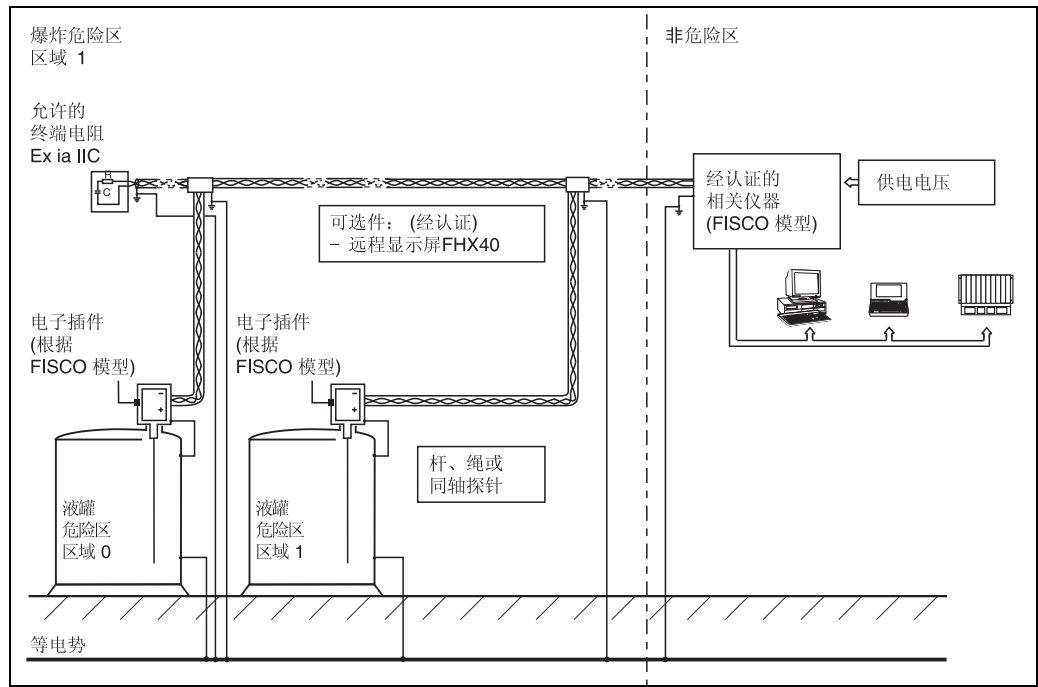

图 4
版本 2

经认证的 关联设备	T12 - OVP	Uo ≤ 17.5 V 或 Uo ≤ 24 V Io ≤ 273 mA 或 Io ≤ 250 mA Po ≤ 1.2 W 或 Po ≤ 1.2 W	PROFIBUS PA 或 FOUNDATION Fieldbus (基金会现场总线) FICSCO 模型 (还原值) [Ex ia] IIC 或 [Ex ib] IIC
	F12, F23	Uo ≤ 17.5 V 或 Uo ≤ 24 V Io ≤ 500 mA 或 Io ≤ 250 mA Po ≤ 5.5 W 或 Po ≤ 1.2 W	PROFIBUS PA 或 FOUNDATION Fieldbus (基金会现场总线) FICSCO 模型 [Ex ia] IIC 或 [Ex ib] IIC

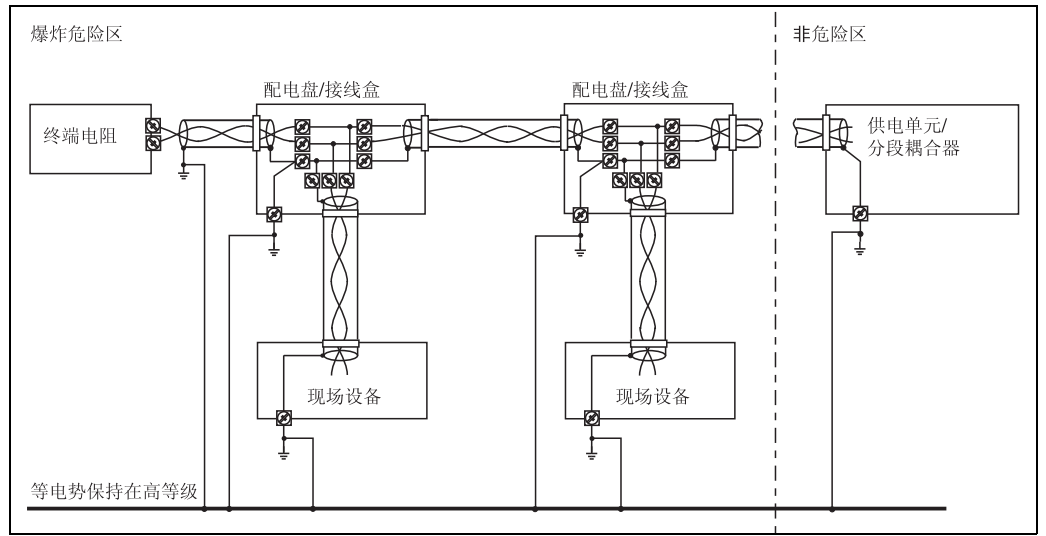
应用	区域 0/1 或 区域 1	探针在区域 0 中, 外壳在区域 1 中或 探针和外壳在区域 1 中
防护类型	Ex ia IIC T6...T1	
最大工作压力	取决于探针	
过程温度	取决于探针	

外壳	T12 - OVP 镀铝 (带有集成过电压保 护装置)	-40 °C ≤ Tu ≤ +80 °C	可选带有或不带有 VU331 显示屏和 操作模块
	F12 镀铝	-40 °C ≤ Tu ≤ +80 °C	可选带有或不带有 VU331 显示屏和 操作模块
	F23 SS 316L	-40 °C ≤ Tu ≤ +80 °C	可选带有或不带有 VU331 显示屏和 操作模块

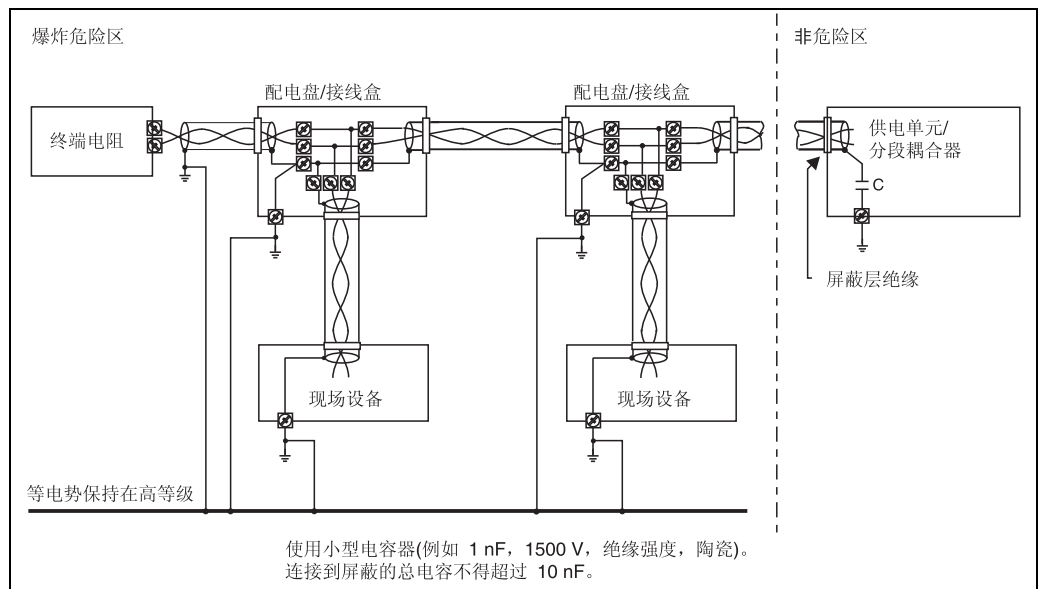
F12, F23 :

可选件	远程显示屏, 例如 FHX40	NEPSI 认证	遵守相关的安全指南
-----	--------------------	----------	-----------

**安全指南:
安装**

- 按照制造商的说明及其它有效标准和规定来安装设备。
- 使用设备时请勿超出指定的电、热和机械参数。
- 外部接地设备应该连接牢固。
- 要接地屏蔽, 请参见图 3 和图 4。
- 电子部件外壳的允许环境温度 (取决于应用范围) 与温度等级之间的关系如下表所示 (表 1a FMP40, 表 1b FMP45)。
- 在对齐 (旋转) 外壳后, 重新拧紧固定螺丝 (参见操作说明)。
- 电缆持续工作温度 ≥ Ta +5 K。
- 仪表的安装方式应能避免在应用期间遭受任何机械损坏或磨损。
请尤其注意流量状况和液罐装置。

T12 - OVP :

- 设备的本质安全型输入电源电路与地电势在电气上隔离。对地绝缘强度限制为 600 V 电气放电装置。

F12, F23 :

- 本安型设备的输入电源电路与地电势是绝缘的, 它相对地电势至少有 500 Vrms 绝缘强度。

FMP43

- 带有独立探针的处于独立模式的设备应以防护盖盖上。

区域 1 - 应用

表 1a **FMP40**

外壳 T12 - OVP						
温度等级， 带有或不带 VU331 显示屏	最大允许输入温度 (工艺连接件) 探针在区域 1 中	电子部件外壳处的最大允许环境温度 (电子部件外壳在区域 1 内) 取决于输入温度				
		带有 3/4" 探针， 紧凑型	带有 3/4" 探针和远程 电子部件 / 隔离管	带有 1 1/2" 探针， 紧凑型	带有 1 1/2" 探针和远程 电子部件 / 隔离管	带有远程 电子部件 / 隔离软管
T6	+ 80 °C + 60 °C	55 °C 60 °C	55 °C 60 °C	55 °C 60 °C	55 °C 60 °C	60 °C 60 °C
T5	+ 95 °C + 75 °C	70 °C 75 °C	70 °C 75 °C	70 °C 75 °C	70 °C 75 °C	75 °C 75 °C
T4	+130 °C + 80 °C	65 °C 80 °C	75 °C 80 °C	65 °C 80 °C	75 °C 80 °C	80 °C 80 °C
T3 (功能型) *1, T2, T1	+150 °C + 80 °C	55 °C 80 °C	75 °C 80 °C	55 °C 80 °C	75 °C 80 °C	80 °C 80 °C

提示： 必须遵守允许的探针温度范围

*1 功能型 = 受限于允许的最大探针温度

外壳 F12						
温度等级， 带有或不带 VU331 显示屏	最大允许输入温度 (工艺连接件) 探针在区域 1 中	电子部件外壳处的最大允许环境温度 (电子部件外壳在区域 1 内) 取决于输入温度				
		带有 3/4" 探针， 紧凑型	带有 3/4" 探针和远程 电子部件 / 隔离管	带有 1 1/2" 探针， 紧凑型	带有 1 1/2" 探针和远程 电子部件 / 隔离管	带有远程 电子部件 / 隔离软管
T6	+ 80 °C + 60 °C	55 °C 60 °C	55 °C 60 °C	55 °C 60 °C	55 °C 60 °C	60 °C 60 °C
T5	+ 95 °C + 75 °C	70 °C 75 °C	70 °C 75 °C	70 °C 75 °C	70 °C 75 °C	75 °C 75 °C
T4	+130 °C + 80 °C	70 °C 80 °C	75 °C 80 °C	70 °C 80 °C	75 °C 80 °C	80 °C 80 °C
T3 (功能型) *1, T2, T1	+150 °C + 80 °C	65 °C 80 °C	75 °C 80 °C	70 °C 80 °C	75 °C 80 °C	80 °C 80 °C

提示： 必须遵守允许的探针温度范围

*1 功能型 = 受限于允许的最大探针温度

外壳 F23						
温度等级， 带有或不带 VU331 显示屏	最大允许输入温度 (工艺连接件) 探针在区域 1 中	电子部件外壳处的最大允许环境温度 (电子部件外壳在区域 1 内) 取决于输入温度				
		带有 ¾" 探针， 紧凑型	带有 ¾" 探针和远程 电子部件 / 隔离管	带有 1½" 探针， 紧凑型	带有 1½" 探针和远程 电子部件 / 隔离管	带有远程 电子部件 / 隔离软管
T6	+ 80 °C + 60 °C	55 °C 60 °C	55 °C 60 °C	55 °C 60 °C	55 °C 60 °C	60 °C 60 °C
T5	+ 95 °C + 75 °C	70 °C 75 °C	70 °C 75 °C	70 °C 75 °C	70 °C 75 °C	75 °C 75 °C
T4	+130 °C + 80 °C	65 °C 80 °C	75 °C 80 °C	65 °C 80 °C	75 °C 80 °C	80 °C 80 °C
T3 (功能型) *1, T2, T1	+150 °C + 80 °C	55 °C 80 °C	75 °C 80 °C	55 °C 80 °C	75 °C 80 °C	80 °C 80 °C

提示： 必须遵守允许的探针温度范围

*1 功能型 = 受限于允许的最大探针温度

表 1b FMP43

外壳 T12 - OVP			
温度等级， 带有或不带 VU331 显示屏	最大允许输入温度 (工艺连接件) 探针在区域 1 中	电子部件外壳处的最大允许温度 (电子部件外壳在区域 1 内) 取决于输入温度	
		紧凑型或紧凑拆卸型	远程，电缆，拆卸型
T6	+ 80 °C + 60 °C	55 °C 60 °C	60 °C 60 °C
T5	+ 95 °C + 75 °C	70 °C 75 °C	75 °C 75 °C
T4	+130 °C + 80 °C	70 °C 80 °C	80 °C 80 °C
T3, T2, T1 (功能型) *1	+150 °C + 80 °C	65 °C 80 °C	80 °C 80 °C

提示： 探针的适用温度必须位于规定的限制范围之内

*1 功能型 = 最大允许的过程温度

外壳 F12			
温度等级， 带有或不带 VU331 显示屏	最大允许输入温度 (工艺连接件) 探针在区域 1 中	电子部件外壳处的最大允许温度 (电子部件外壳在区域 1 内) 取决于输入温度	
		紧凑型或紧凑拆卸型	远程，电缆，拆卸型
T6	+ 80 °C + 60 °C	55 °C 60 °C	60 °C 60 °C
T5	+ 95 °C + 75 °C	70 °C 75 °C	75 °C 75 °C
T4	+130 °C + 80 °C	70 °C 80 °C	80 °C 80 °C
T3, T2, T1 (功能型) *1	+150 °C + 80 °C	65 °C 80 °C	80 °C 80 °C

提示： 探针的适用温度必须位于规定的限制范围之内

*1 功能型 = 最大允许的过程温度

外壳 F23			
温度等级， 带有或不带 VU331 显示屏	最大允许输入温度 (工艺连接件) 探针在区域 1 中	电子部件外壳处的最大允许温度 (电子部件外壳在区域 1 内) 取决于输入温度	
		紧凑型或紧凑拆卸型	远程，电缆，拆卸型
T6	+ 80 °C + 60 °C	55 °C 60 °C	60 °C 60 °C
T5	+ 95 °C + 75 °C	70 °C 75 °C	75 °C 75 °C
T4	+130 °C + 80 °C	65 °C 80 °C	80 °C 80 °C
T3, T2, T1 (功能型) *1	+150 °C + 80 °C	55 °C 80 °C	80 °C 80 °C

提示： 探针的适用温度必须位于规定的限制范围之内

*1 功能型 = 最大允许的过程温度

表 1c FMP45

外壳 T12 - OVP				
温度等级， 带有或不带 VU331 显示屏	最大允许输入温度 (工艺连接件) 探针在区域 1 中	电子部件外壳处的最大允许环境温度 (电子部件外壳在区域 1 内) 取决于输入温度		
		类型 A (XT 版本)	类型 B (HT 版本)	带有远程电子部件 / 隔离软管
T6	+ 80 °C + 60 °C	58 °C 60 °C	59 °C 60 °C	60 °C 60 °C
T5	+ 95 °C + 75 °C	73 °C 75 °C	74 °C 75 °C	75 °C 75 °C
T4	+130 °C + 80 °C	76 °C 80 °C	78 °C 80 °C	80 °C 80 °C
T3 (功能型) *1	+150 °C + 80 °C	74 °C 80 °C	74 °C 80 °C	80 °C 80 °C
T3	+195 °C + 80 °C	72 °C 80 °C	75 °C 80 °C	80 °C 80 °C
T2 (功能型) *1	+250 °C + 80 °C	68 °C 80 °C	70 °C 80 °C	80 °C 80 °C
T2 (功能型) *1	+290 °C + 80 °C	280 °C: 66 °C 80 °C	72 °C 80 °C	80 °C 80 °C
T1 (功能型) *1	+400 °C + 80 °C	不允许	67 °C 80 °C	80 °C 80 °C

提示： 必须遵守允许的探针温度范围

*1 功能型 = 受限于允许的最大探针温度

外壳 F12				
温度等级， 带有或不带 VU331 显示屏	最大允许输入温度 (工艺连接件) 探针在区域 1 中	电子部件外壳处的最大允许环境温度 (电子部件外壳在区域 1 内) 取决于输入温度		
		类型 A (XT 版本)	类型 B (HT 版本)	带有远程电子部件 / 隔离软管
T6	+ 80 °C + 60 °C	58 °C 60 °C	59 °C 60 °C	60 °C 60 °C
T5	+ 95 °C + 75 °C	73 °C 75 °C	74 °C 75 °C	75 °C 75 °C
T4	+130 °C + 80 °C	76 °C 80 °C	77 °C 80 °C	80 °C 80 °C
T3 (功能型) *1	+150 °C + 80 °C	74 °C 80 °C	76 °C 80 °C	80 °C 80 °C
T3	+195 °C + 80 °C	72 °C 80 °C	75 °C 80 °C	80 °C 80 °C
T2 (功能型) *1	+250 °C + 80 °C	69 °C 80 °C	73 °C 80 °C	80 °C 80 °C
T2 (功能型) *1	+290 °C + 80 °C	280 °C: 67 °C 80 °C	71 °C 80 °C	80 °C 80 °C
T1 (功能型) *1	+400 °C + 80 °C	不允许	66 °C 80 °C	80 °C 80 °C

提示： 必须遵守允许的探针温度范围

*1 功能型 = 受限于允许的最大探针温度

外壳 F23				
温度等级， 带有或不带 VU331 显示屏	最大允许输入温度 (工艺连接件) 探针在区域 1 中	电子部件外壳处的最大允许环境温度 (电子部件外壳在区域 1 内) 取决于输入温度		
		类型 A (XT 版本)	类型 B (HT 版本)	带有远程电子部件 / 隔离软管
T6	+ 80 °C + 60 °C	57 °C 60 °C	58 °C 60 °C	60 °C 60 °C
T5	+ 95 °C + 75 °C	72 °C 75 °C	73 °C 75 °C	75 °C 75 °C
T4	+130 °C + 80 °C	74 °C 80 °C	76 °C 80 °C	80 °C 80 °C
T3 (功能型) *1	+150 °C + 80 °C	69 °C 80 °C	74 °C 80 °C	80 °C 80 °C
T3	+195 °C + 80 °C	66 °C 80 °C	70 °C 80 °C	80 °C 80 °C
T2 (功能型) *1	+250 °C + 80 °C	60 °C 80 °C	66 °C 80 °C	80 °C 80 °C
T2 (功能型) *1	+290 °C + 80 °C	280 °C: 56 °C 80 °C	63 °C 80 °C	80 °C 80 °C
T1 (功能型) *1	+400 °C + 80 °C	不允许	54 °C 80 °C	80 °C 80 °C

提示： 必须遵守允许的探针温度范围

*1 功能型 = 受限于允许的最大探针温度

- 当设备连接到经认证的 IIC 和 IIB 设备组的 Ex ib 类本安型电路时，防护类型作如下改变：
Ex ib IIC T6 和 Ex ib IIB T6。
如果变送器连接到 Ex ib 类的本安型电路，则不要在区域 0 中操作探针。
- 改动设备的电气和机械部件会降低防爆保护的类型，用户请勿擅自改动。

过电压保护

T12 - OVP:

- 集成的过电压保护装置满足 IEC/EN 60079-14 第 12.3 节中规定的要求
- FMP43：“分离式远程电缆”可能具有附加措施。

F12, F23:

- 对于按照国家规范或标准要求进行过电压保护的装置，安装本设备时应使用过电压保护装置。

表 2a

电源和信号电路的防护类型：
本安型 Ex ia IIC 或 IIB

Levelflex M，带 PROFIBUS PA 或 FOUNDATION Fieldbus (基金会现场总线) 电子插件，Ex ia IIC (FISCO 模型)			
T12 - OVP (还原值)	U _i = 17.5 V I _i = 273 mA P _i = 1.2 W	或	U _i = 24 V I _i = 250 mA P _i = 1.2 W
			L _i = 10 μH C _i = 5 nF 泄漏电流 ≤ 50 μA
F12, F23	U _i = 17.5 V I _i = 500 mA P _i = 5.5 W	或	U _i = 24 V I _i = 250 mA P _i = 1.2 W
			L _i = 10 μH C _i = 5 nF 泄漏电流 ≤ 50 μA

表 2b

远程显示屏 (例如 FHX40) 的电源和信号电路所使用的防护类型为：
本安型 Ex ia IIC 或 IIB

F12, F23	U _o = 4.2 V I _o = 34 mA P _o = 36 mW	有效内部电感 有效内部电容 特征曲线	L _i = 可忽略 C _i = 可忽略 线性	C _o = 4 μF L _o = 5 mH
-----------------	--	--------------------------	--	--

- 仪器与关联设备之间的连接标准如下：
U_o ≤ U_i，I_o ≤ I_i，P_o ≤ P_i，C_o ≥ C_i+C_c，L_o ≥ L_i+L_c
注意：C_c 和 L_c 代表电缆的分布电容和分布电感。

安全指南：
区域 0

- 只有在下列大气条件下才能在有爆炸可能的蒸汽 / 空气混合物中操作设备 *2：
-20 °C ≤ T ≤ +60 °C
0.8 bar ≤ p ≤ 1.1 bar
- 如果不存在可能爆炸的混合物，则变送器可在符合制造商技术规范的其他大气条件下运行。
- 当仪表的受潮部件对介质具有足够耐久性时，才可将仪表安装于介质中。
- 在本安型和非本安型电路间最好采用电气隔离的关联设备。
- 在安装、使用和维护设备时，用户必须遵守操作手册和下列标准中规定的要求：
 - GB50257-1996：“电气设备安装工程 爆炸和火灾危险环境电气装置施工及验收规范”。
 - GB3836.13-1997：“爆炸性气体环境用电气设备，第 13 部分：爆炸性气体环境用电气设备的检修”。
 - GB3836.15-2000：“爆炸性气体环境用电气设备，第 15 部分：危险场所电气安装 (煤矿除外)”。
 - GB3836.16-2006：“爆炸性气体环境用电气设备，第 16 部分：电气装置的检查和维护 (煤矿除外)”。

区域 0 - 应用

表 3a FMP40

T12 - OVP, F12, F23						
温度等级， 带有或不带 VU331 显示屏	最大允许输入温度 (工艺连接件) 探针在区域 0 中 *2	电子部件外壳处的最大允许环境温度 (电子部件外壳在区域 1 内) 取决于输入温度				
		带有 3/4" 探针， 紧凑型	带有 3/4" 探针和远程 电子部件 / 隔离管	带有 1 1/2" 探针， 紧凑型	带有 1 1/2" 探针和远程 电子部件 / 隔离管	带有远程 电子部件 / 隔离软管
T6	+60 °C	60 °C	60 °C	60 °C	60 °C	60 °C
T5	+60 °C	75 °C	75 °C	75 °C	75 °C	75 °C
T4, T3, T2, T1	+60 °C	80 °C	80 °C	80 °C	80 °C	80 °C

表 3b FMP43

T12 - OVP			
温度等级， 带有或不带 VU331 显示屏	最大允许输入温度 (工艺连接件) 探针在区域 0 中 *2	电子部件外壳处的最大允许温度 (电子部件外壳在区域 1 内) 取决于输入温度	
		紧凑型或紧凑拆卸型	远程，电缆，拆卸型
T6	+60 °C	55 °C	60 °C
	+60 °C	60 °C	60 °C
T5	+60 °C	70 °C	75 °C
	+60 °C	75 °C	75 °C
T4	+60 °C	70 °C	80 °C
	+60 °C	80 °C	80 °C
T3, T2, T1 (功能型) *1	+60 °C	65 °C	80 °C
	+60 °C	80 °C	80 °C

提示： 探针的适用温度必须位于规定的限制范围之内

*1 功能型 = 最大允许的过程温度

F12, F23			
温度等级， 带有或不带 VU331 显示屏	最大允许输入温度 (工艺连接件) 探针在区域 0 中 *2	电子部件外壳处的最大允许温度 (电子部件外壳在区域 1 内) 取决于输入温度	
		紧凑型或紧凑拆卸型	远程，电缆，拆卸型
T6	+60 °C	60 °C	60 °C
T5	+60 °C	75 °C	75 °C
T4	+60 °C	80 °C	80 °C
T3, T2, T1 (功能型) *1	+60 °C	80 °C	80 °C

提示： 探针的适用温度必须位于规定的限制范围之内

*1 功能型 = 最大允许的过程温度

表 3c FMP45

T12 - OVP, F12, F23				
温度等级, 带有或不带 VU331 显示屏	最大允许输入温度 (工艺连接件) 探针在区域 0 中 *2	电子部件外壳处的最大允许环境温度 (电子部件外壳在区域 1 内) 取决于输入温度		
		类型 A (XT 版本)	类型 B (HT 版本)	带有远程电子部件 / 隔离软管
T6	+60 °C	60 °C	60 °C	60 °C
T5	+60 °C	75 °C	75 °C	75 °C
T4, T3, T2, T1	+60 °C	80 °C	80 °C	80 °C

www.endress.com/worldwide

Endress+Hauser 

People for Process Automation

