

Technical Information

Omnigrad T TR24

Modular RTD assembly



Threaded or weld-in compression fitting

Application

- Universal range of application
- Measuring range: -200 to 600 °C (-328 to 1 112 °F)
- Pressure range up to 50 bar (725 psi)
- Degree of protection up to IP68

Head transmitter

All Endress+Hauser transmitters are available with enhanced accuracy and reliability compared to directly wired sensors. Easy customizing by choosing one of the following outputs and communication protocols:

- Analog output 4 to 20 mA
- HART®
- PROFIBUS® PA
- FOUNDATION Fieldbus™

Your benefits

- High degree of flexibility thanks to modular design with standard terminal heads as per DIN EN 50446 and customer-specific immersion lengths
- High degree of insert compatibility and design as per DIN 43772
- Fast response time with reduced tip form
- Types of protection for use in hazardous locations:
 - Intrinsic Safety (Ex ia)
 - Non-sparking (Ex nA)

Function and system design

Measuring principle

Resistance thermometer (RTD)

These resistance thermometers use a Pt100 temperature sensor according to IEC 60751. The temperature sensor is a temperature-sensitive platinum resistor with a resistance of 100 Ω at 0 °C (32 °F) and a temperature coefficient $\alpha = 0.003851 \text{ } ^\circ\text{C}^{-1}$.

There are generally two different kinds of platinum resistance thermometers:

- **Wire wound (WW):** Here, a double coil of fine, high-purity platinum wire is located in a ceramic support. This is then sealed top and bottom with a ceramic protective layer. Such resistance thermometers not only facilitate very reproducible measurements but also offer good long-term stability of the resistance/temperature characteristic within temperature ranges up to 600 °C (1 112 °F). This type of sensor is relatively large in size and it is comparatively sensitive to vibrations.
- **Thin film platinum resistance thermometers (TF):** A very thin, ultrapure platinum layer, approx. 1 μm thick, is vaporized in a vacuum on a ceramic substrate and then structured photolithographically. The platinum conductor paths formed in this way create the measuring resistance. Additional covering and passivation layers are applied and reliably protect the thin platinum layer from contamination and oxidation, even at high temperatures.

The primary advantages of thin film temperature sensors over wire wound versions are their smaller sizes and better vibration resistance. A relatively low principle-based deviation of the resistance/temperature characteristic from the standard characteristic of IEC 60751 can frequently be observed among TF sensors at high temperatures. As a result, the tight limit values of tolerance category A as per IEC 60751 can only be observed with TF sensors at temperatures up to approx. 300 °C (572 °F).

Measuring system

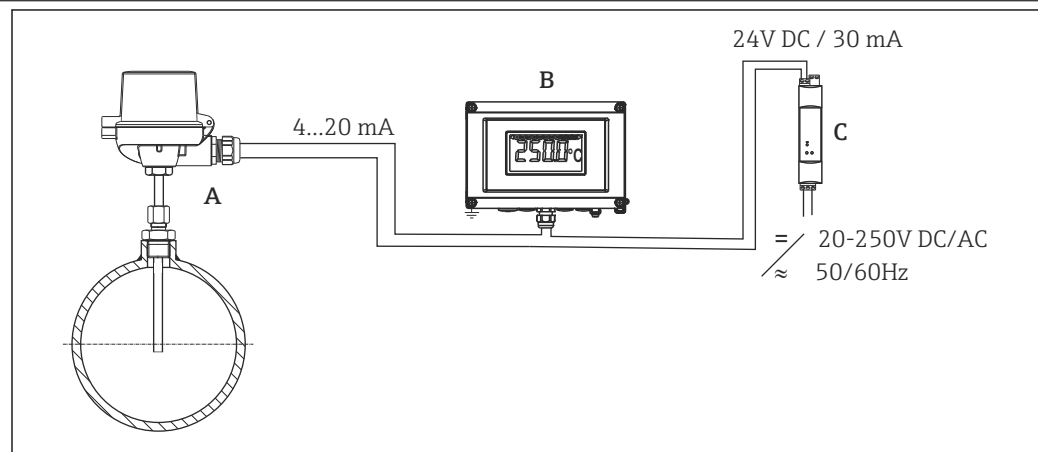

A0009647

1 Application example

- A Mounted thermometer with head transmitter installed.
- B RIA16 field display unit - The display unit records the analog measuring signal from the head transmitter and shows this on the display. The LC display shows the current measured value in digital form and as a bar graph indicating a limit value violation. The display unit is looped into the 4 to 20 mA circuit and gets the required energy from there. More information on this can be found in the Technical Information (see "Documentation").
- C Active barrier RN221N - The RN221N (24 V DC, 30 mA) active barrier has a galvanically isolated output for supplying voltage to loop-powered transmitters. The universal power supply works with an input supply voltage of 20 to 250 V DC/AC, 50/60 Hz, which means that it can be used in all international power grids. More information on this can be found in the Technical Information (see "Documentation").

Equipment architecture

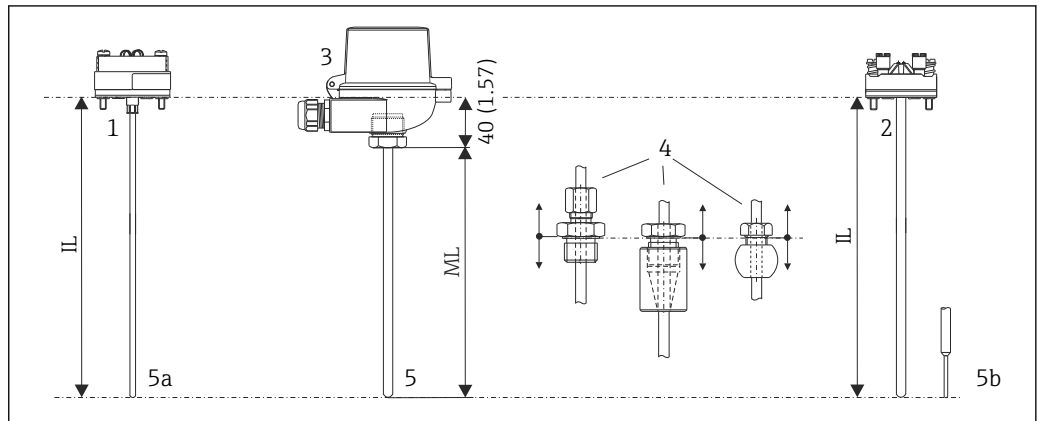

A0009740

2 Equipment architecture of the thermometer

- 1 Insert with head transmitter mounted (example with $\phi 3$ mm (0.12 in))
- 2 Insert with terminal block mounted (example with $\phi 6$ mm (0.24 in))
- 3 Terminal head
- 4 Process connection: compression fittings TA50, TA56, TA70
- 5 Various tip shapes - detailed information see chapter "Tip shape":
- 5a Straight for inserts with $\phi 3$ mm (0.12 in)
- 5b Straight or reduced for inserts with $\phi 6$ mm (0.24 in)
- ML Immersion length
- IL Insertion length = $ML + 40$ mm (1.57 in)

The Omnigrad T TR24 RTD assemblies have a modular design. The terminal head is used as a connection module for the mechanical and electrical connection of the insert. The position of the actual thermometer sensor in the insert ensures that it is mechanically protected. Either ceramic terminal blocks or transmitters can be fitted to the internal base washer. The TR24 can be fitted onto a pipe or tank through the use of a compression fitting, which can be chosen from the most common models.

Measurement range

RTD: -200 to 600 °C (-328 to 1112 °F) according to IEC 60751

Performance characteristics

Operating conditions

Ambient temperature range

Terminal head	Temperature in °C (°F)
Without mounted head transmitter	Depends on the terminal head used and the cable gland or fieldbus connector, see 'Terminal heads' section
With mounted head transmitter	-40 to 85 °C (-40 to 185 °F)
With mounted head transmitter and display	-20 to 70 °C (-4 to 158 °F)

Process pressure

Maximum process temperature and pressure for using the compression fitting (TA50) or weld in adapter (TA56, TA70) see chapter "Process connection" → 11.

Permitted flow velocity depending on the immersion length

The highest flow velocity tolerated by the thermometer diminishes with increasing immersion length exposed to the stream of the fluid. In addition it is dependent on the diameter of the thermometer tip, on the kind of measuring medium, on the process temperature and on the process pressure.

Shock and vibration resistance

4G / 2 to 150 Hz according to IEC 60068-2-6

Accuracy

RTD resistance thermometer as per IEC 60751

Class	max. tolerances (°C)	Characteristics
Cl. AA, former 1/3 Cl. B	$\pm (0.1 + 0.0017 \cdot t ^{1.1})$	
Cl. A	$\pm (0.15 + 0.002 \cdot t ^{1.1})$	
Cl. B	$\pm (0.3 + 0.005 \cdot t ^{1.1})$	
Temperature ranges for compliance with the tolerance classes		
Wire wound sensor (WW):	Cl. A	Cl. AA
	-100 to +450 °C	-50 to +250 °C
Thin-film version (TF):	Cl. A	Cl. AA
	-30 to +300 °C	0 to +150 °C
	-30 to +300 °C	0 to +150 °C
<ul style="list-style-type: none"> ■ Standard ■ iTHERM StrongSens 		

1) $|t|$ = absolute value °C

 In order to obtain the maximum tolerances in °F, the results in °C must be multiplied by a factor of 1.8.

Response time

Calculated at an ambient temperature of approx. 23 °C by immersing in running water (0.4 m/s flow rate, 10 K excess temperature):

Insert diameter	Response time	
	6 mm (0.24 in)	t ₅₀
t ₉₀		8 s
3 mm (0.12 in)	t ₅₀	2 s
	t ₉₀	5 s
6 mm (0.24 in) / 3 mm (0.12 in)	t ₅₀	2 s
	t ₉₀	5 s

 Response time for the sensor assembly without transmitter.

Insulation resistance

Insulation resistance ≥ 100 MΩ at ambient temperature.

Insulation resistance between the terminals and the outer jacket is measured with a minimum voltage of 100 V DC.

Self heating

RTD elements are passive resistances that are measured using an external current. This measurement current causes a self-heating effect in the RTD element itself which in turn creates an additional measurement error. In addition to the measurement current, the size of the measurement error is also affected by the temperature conductivity and flow velocity of the process. This self-heating error is negligible when an Endress+Hauser iTEMP temperature transmitter (very small measurement current) is connected.

Calibration

Endress+Hauser provides comparison temperature calibration from -80 to +600 °C (-110 to +1112 °F) based on the International Temperature Scale (ITS90). Calibrations are traceable to national and international standards. The calibration certificate is referenced to the serial number of the thermometer. Only the insert is calibrated.

Insert: ø6 mm (0.24 in) and 3 mm (0.12 in)	Minimum insertion length of insert in mm (in) ¹⁾
Temperature range	With or without head transmitter
-80 to +250 °C (-110 to +480 °F)	No minimum insertion length is required
+251 to +550 °C (+484 to +1020 °F)	300 (11.81)
+551 to +600 °C (1024 to 1112 °F)	400 (15.75)

1) In case of head-mounted transmitter, the minimum insertion length for calibrations is 50 mm (1.97 in) for temperatures > +80 °C (+176 °F)

Material

Process connection, insert

The temperatures for continuous operation specified in the following table are only intended as reference values for use of the various materials in air and without any significant compressive load.

The maximum operation temperatures are reduced considerably in some cases where abnormal conditions such as high mechanical load occur or in aggressive media.

Material name	Short form	Recommended max. temp. for continuous use in air	Properties
AISI 316/1.4401	X5CrNiMo 17-12-2	650 °C (1202 °F) ¹⁾	<ul style="list-style-type: none"> ■ Austenitic, stainless steel ■ High corrosion resistance in general ■ Particularly high corrosion resistance in chlorine-based and acidic, non-oxidizing atmospheres through the addition of molybdenum (e.g. phosphoric and sulfuric acids, acetic and tartaric acids with a low concentration)
AISI 316L/ 1.4404 1.4435	X2CrNiMo17-12-2 X2CrNiMo18-14-3	650 °C (1202 °F)	<ul style="list-style-type: none"> ■ Austenitic, stainless steel ■ High corrosion resistance in general ■ Particularly high corrosion resistance in chlorine-based and acidic, non-oxidizing atmospheres through the addition of molybdenum (e.g. phosphoric and sulfuric acids, acetic and tartaric acids with a low concentration) ■ Increased resistance to intergranular corrosion and pitting ■ Compared to 1.4404, 1.4435 has even higher corrosion resistance and a lower delta ferrite content
PTFE (Teflon)	Polytetrafluorethylen	200 °C (392 °F)	<ul style="list-style-type: none"> ■ Resistant to almost all chemicals ■ High temperature stability

- 1) Can be used to a limited extent up to 800 °C (1472 °F) for low compressive loads and in non-corrosive media. Please contact your Endress+Hauser sales team for further information.

Components

Family of temperature transmitters

Thermometers fitted with iTEMP transmitters are an installation-ready complete solution to improve temperature measurement by significantly increasing accuracy and reliability, when compared to direct wired sensors, as well as reducing both wiring and maintenance costs.

PC programmable head transmitters

They offer a high degree of flexibility, thereby supporting universal application with low inventory storage. The iTEMP transmitters can be configured quickly and easily at a PC. Endress+Hauser offers free configuration software which can be downloaded from the Endress+Hauser Website. More information can be found in the Technical Information.

HART® programmable head transmitters

The transmitter is a 2-wire device with one or two measuring inputs and one analog output. The device not only transfers converted signals from resistance thermometers and thermocouples, it also transfers resistance and voltage signals using HART® communication. It can be installed as an intrinsically safe apparatus in Zone 1 hazardous areas and is used for instrumentation in the terminal head (flat face) as per DIN EN 50446. Swift and easy operation, visualization and maintenance by PC using operating software, Simatic PDM or AMS. For more information, see the Technical Information.

PROFIBUS® PA head transmitters

Universally programmable head transmitter with PROFIBUS® PA communication. Conversion of various input signals into digital output signals. High accuracy over the complete ambient temperature range. Swift and easy operation, visualization and maintenance using a PC directly from the control panel, e. g. using operating software, Simatic PDM or AMS. For more information, see the Technical Information.

FOUNDATION Fieldbus™ head transmitters

Universally programmable head transmitter with FOUNDATION Fieldbus™ communication. Conversion of various input signals into digital output signals. High accuracy over the complete

ambient temperature range. Swift and easy operation, visualization and maintenance using a PC directly from the control panel, e.g. using operating software such as ControlCare from Endress +Hauser or NI Configurator from National Instruments. For more information, see the Technical Information.

Advantages of the iTEMP transmitters:

- Dual or single sensor input (optionally for certain transmitters)
- Pluggable display (optionally for certain transmitters)
- Unsurpassed reliability, accuracy and long-term stability in critical processes
- Mathematical functions
- Monitoring of the thermometer drift, sensor backup functionality, sensor diagnostic functions
- Sensor-transmitter matching for dual sensor input transmitters, based on Callendar/Van Dusen coefficients

Terminal heads

All terminal heads have an internal shape and size in accordance with DIN EN 50446 flat face and a thermometer connection of M24x1.5, G½" or ½" NPT thread. All dimensions in mm (in). The cable glands in the diagrams correspond to M20x1.5 connections. Specifications without head transmitter installed. For ambient temperatures with head transmitter installed, see "Operating conditions" section → 4.

TA30A	Specification
	<ul style="list-style-type: none"> ■ Protection class: <ul style="list-style-type: none"> - IP66/68 (NEMA Type 4x incl.) - For ATEX: IP66/67 ■ Temperature: -50 to +150 °C (-58 to +302 °F) without cable gland ■ Material: aluminum, polyester powder coated ■ Seals: silicone ■ Threaded cable entry: G ½", ½" NPT and M20x1.5; ■ Protection armature connection: M24x1.5 ■ Head color: blue, RAL 5012 ■ Cap color: gray, RAL 7035 ■ Weight: 330 g (11.64 oz) ■ Ground terminal, internal and external ■ With 3-A symbol

TA30A with display window	Specification
	<ul style="list-style-type: none"> ■ Protection class: <ul style="list-style-type: none"> - IP66/68 (NEMA Type 4x incl.) - For ATEX: IP66/67 ■ Temperature: -50 to +150 °C (-58 to +302 °F) without cable gland ■ Material: aluminum, polyester powder coated ■ Seals: silicone ■ Threaded cable entry: G ½", ½" NPT and M20x1.5 ■ Protection armature connection: M24x1.5 ■ Head color: blue, RAL 5012 ■ Cap color: gray, RAL 7035 ■ Weight: 420 g (14.81 oz) ■ With TID10 display ■ Ground terminal, internal and external ■ 3-A marked

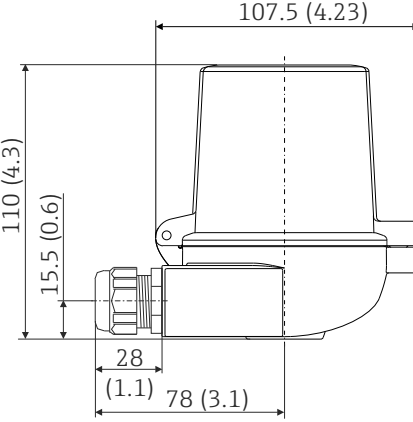
TA30D	Specification
 <p>A0009822</p>	<ul style="list-style-type: none"> ■ Protection class: <ul style="list-style-type: none"> - IP66/68 (NEMA Type 4x encl.) - For ATEX: IP66/67 ■ Temperature: -50 to +150 °C (-58 to +302 °F) without cable gland ■ Material: aluminum, polyester powder coated Seals: silicone ■ Threaded cable entry: G ½", ½" NPT and M20x1.5 ■ Protection armature connection: M24x1.5 ■ Two head transmitters can be mounted. In the standard version, one transmitter is mounted in the terminal head cover and an additional terminal block is installed directly on the insert. ■ Head color: blue, RAL 5012 ■ Cap color: gray, RAL 7035 ■ Weight: 390 g (13.75 oz) ■ Ground terminal, internal and external ■ With 3-A symbol

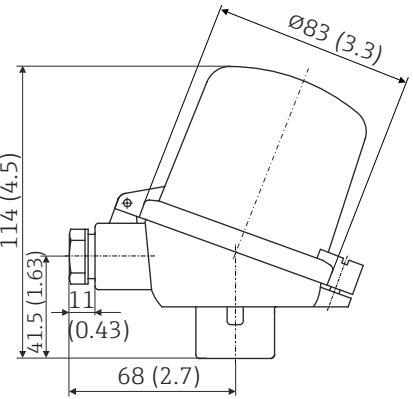
TA30P	Specification
 <p>A0012930</p>	<ul style="list-style-type: none"> ■ Protection class: IP65 ■ Max. temperature: -40 to +120 °C (-40 to +248 °F) ■ Material: polyamide (PA), antistatic Seals: silicone ■ Threaded cable entry: M20x1.5 ■ Protection armature connection: M24x1.5 ■ Two head transmitters can be mounted. In the standard version, one transmitter is mounted in the terminal head cover and an additional terminal block is installed directly on the insert. ■ Head and cap color: black ■ Weight: 135 g (4.8 oz) ■ Types of protection for use in hazardous locations: Intrinsic Safety (G Ex ia) ■ Ground terminal: only internal via auxiliary clamp

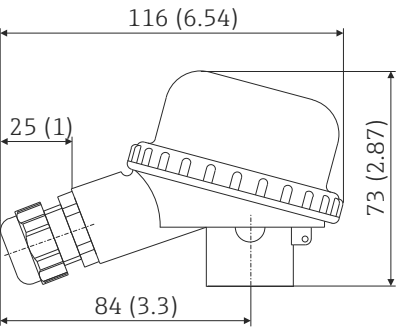
TA20B	Specification
 <p>A0008663</p>	<ul style="list-style-type: none"> ■ Protection class: IP65 ■ Max. temperature: -40 to +80 °C (-40 to +176 °F) without cable gland ■ Material: polyamide (PA) ■ Cable entry: M20x1.5 ■ Head and cap color: black ■ Weight: 80 g (2.82 oz) ■ 3-A[®] marked

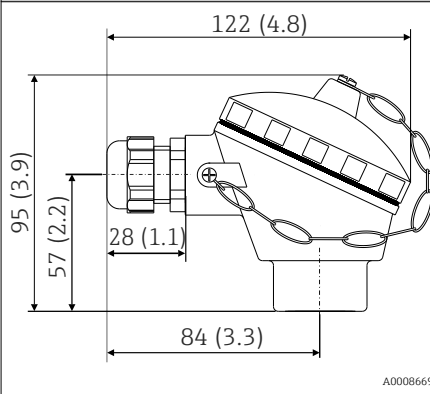
TA21E	Specification
 <p style="text-align: right; font-size: small;">A0008669</p>	<ul style="list-style-type: none"> ■ Protection class: IP65 (NEMA Type 4x encl.) ■ Temperature: -40 to 130 °C (-40 to 266 °F) silicone, up to 100 °C (212 °F) rubber seal without cable gland (observe max. permitted temperature of the cable gland!) ■ Material: aluminum alloy with polyester or epoxy coating, rubber or silicone seal under the cover ■ Cable entry: M20x1.5 or plug M12x1 PA ■ Protection armature connection: M24x1.5, G 1/2" or NPT 1/2" ■ Head color: blue, RAL 5012 ■ Cap color: gray, RAL 7035 ■ Weight: 300 g (10.58 oz) ■ 3-A[®] marked

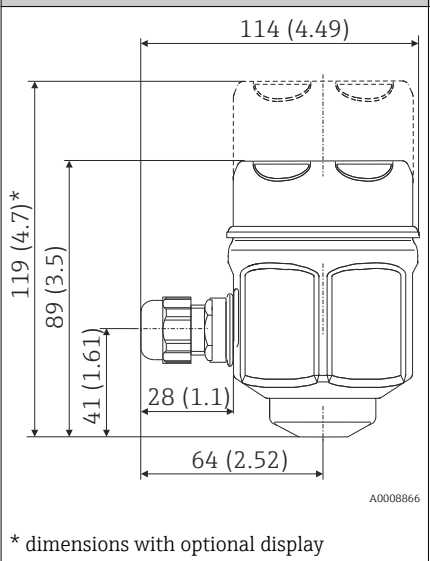
TA20J	Specification
 <p style="text-align: right; font-size: small;">A0008866</p> <p>* dimensions with optional display</p>	<ul style="list-style-type: none"> ■ Protection class: IP66/IP67 (NEMA Type 4x encl.) ■ Temperature: -40 to 70 °C (-40 to 158 °F) without cable gland ■ Material: 316L (1.4404) stainless steel, rubber seal under the cover (hygienic design) ■ 4 digits 7-segments LC display (loop powered with optional 4 to 20 mA transmitter) ■ Cable entry: 1/2" NPT, M20x1.5 or plug M12x1 PA ■ Protection armature connection: M24x1.5 or 1/2" NPT ■ Head and cap color: stainless steel, polished ■ Weight: 650 g (22.93 oz) with display ■ Humidity: 25 to 95 %, no condensation ■ 3-A[®] marked <p>The programming is executed through 3 keys at the bottom of the display.</p>

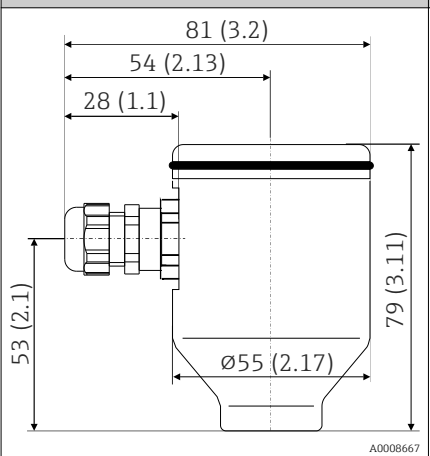
TA20R	Specification
 <p style="text-align: right; font-size: small;">A0008667</p>	<ul style="list-style-type: none"> ■ Protection class: IP66/67 ■ Max. temperature: -40 to +100 °C (-40 to +212 °F) without cable gland ■ Material: SS 316L (1.4404) stainless steel ■ Cable entry: 1/2" NPT, M20x1.5 or plug M12x1 PA ■ Head and cap color: stainless steel ■ Weight: 550 g (19.4 oz) ■ LABS-free ■ 3-A[®] marked

Maximum ambient temperatures for cable glands and fieldbus connectors	
Type	Temperature range
Cable gland ½" NPT, M20x1.5 (non Ex)	-40 to +100 °C (-40 to +212 °F)
Cable gland M20x1.5 (for dust ignition-proof area)	-20 to +95 °C (-4 to +203 °F)
Fieldbus connector (M12x1 PA, 7/8" FF)	-40 to +105 °C (-40 to +221 °F)

Design

All dimensions in mm (in).

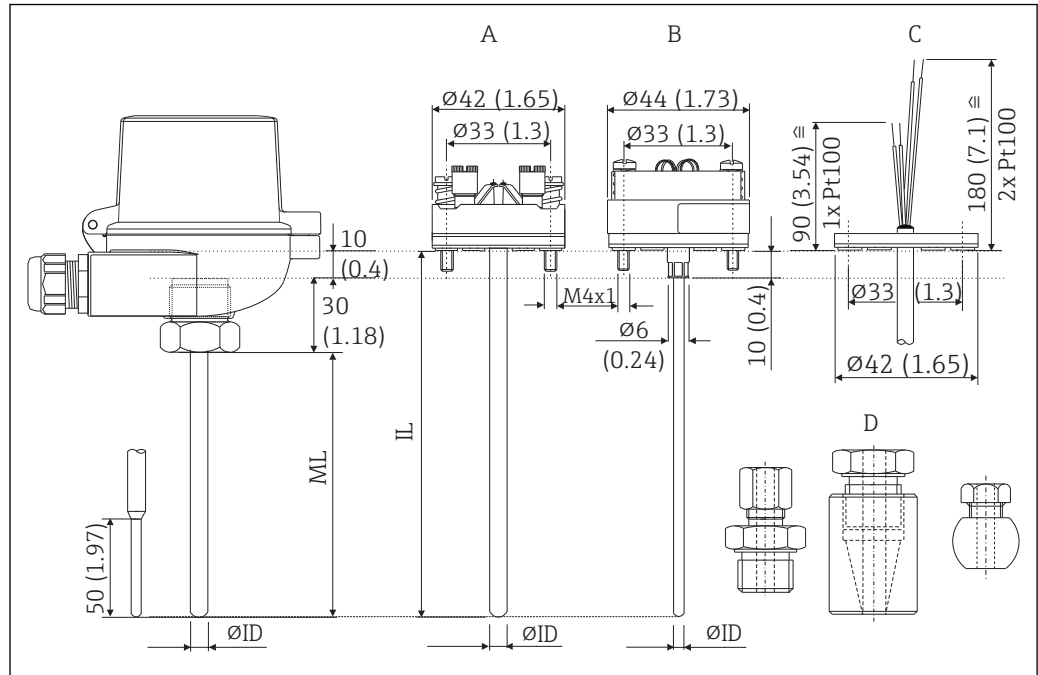

A0009747

3 Dimensions of the Omnigrad T TR24

- A Insert with terminal block mounted
- B Insert with head transmitter mounted
- C Insert with flying leads
- D Compression fittings
- ØID Insert diameter with Ø6 mm (0.24 in) or Ø3 mm (0.12 in)
- IL Insertion length = ML + 40 mm (1.57 in)
- ML Immersion length

Tip shape

Tip shape	Insert diameter
Reduced	Ø6 mm (0.24 in) / Ø3 mm (0.12 in) x 50 mm (1.97 in)
Straight	Ø6 mm (0.24 in) or Ø3 mm (0.12 in)

Weight

0.5 to 2.5 kg (1 to 5.5 lbs) for standard options.

Process connection

The process connection is the connection between the process and the thermometer. When using a compression fitting the thermometer is pushed through a gland and fixed using a compression ferrule (can be loosened) or a metal ferrule (cannot be loosened).

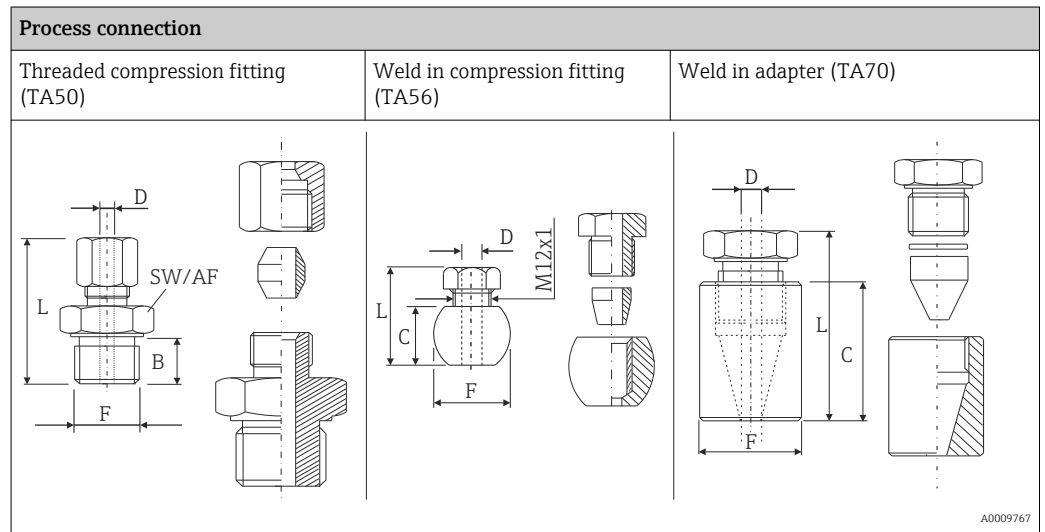

Model	F in mm (in)		L in mm (in)	C in mm (in)	B in mm (in)	Material ferrule	Max. process temperature	Max. process pressure
TA50	G½"	SW/AF 27	47 (1.85)	-	15 (0.6)	SS316 ¹⁾	800 °C (1 472 °F)	40 bar at 20 °C (580 psi at 68 °F)
						PTFE ²⁾	200 °C (392 °F)	10 bar at 20 °C (145 psi at 68 °F)
	NPT½"	SW/AF 22	50 (1.97)	-	20 (0.8)	SS316	800 °C (1 472 °F)	40 bar at 20 °C (580 psi at 68 °F)
						PTFE	200 °C (392 °F)	10 bar at 20 °C (145 psi at 68 °F)
TA56	Weld-in 25 (0.98)		30 (1.18)	18 (0.71)	-	PEEK	200 °C (392 °F)	140 bar at 20 °C (2030 psi at 68 °F)
TA70	Weld-in 30 (1.18)		76 (3)	34 (1.34)	-	Silopren®	180 °C (356 °F)	20 bar at 20 °C (290 psi at 68 °F)

- 1) SS316 compression ferrule: Can only be used once, the compression fitting cannot be repositioned on the protection tube after loosening. Fully adjustable immersion length on initial installation.
- 2) PTFE/Silopren®-compression ferrule: Can be reused, after loosening the fitting can be moved up and down the protection tube. With fully adjustable immersion length.

Spare parts

The RTD insert is available as spare part TPR100 (see Technical Information in chapter "Documentation" → 17)

If spare parts are required, refer to the following equation:

Insertion length IL = ML + 40 mm (1.57 in)

Spare part	Order code
Compression fitting TA50, Ø6 mm (0.24 in), gasket SS316 or PTFE, process connection ½" NPT or G½"	TA50-.....
O-Ring 44,17x1,78 EPDM labs free black	71142762

Spare part	Order code
Gasket spares TA50 ϕ 6.1 mm (0.24 in), SS316 (10 pieces)	60011599
Gasket spares TA50 ϕ 6.1 mm (0.24 in), PTFE (10 pieces)	60011600

Wiring

Wiring diagrams for RTD

Type of sensor connection

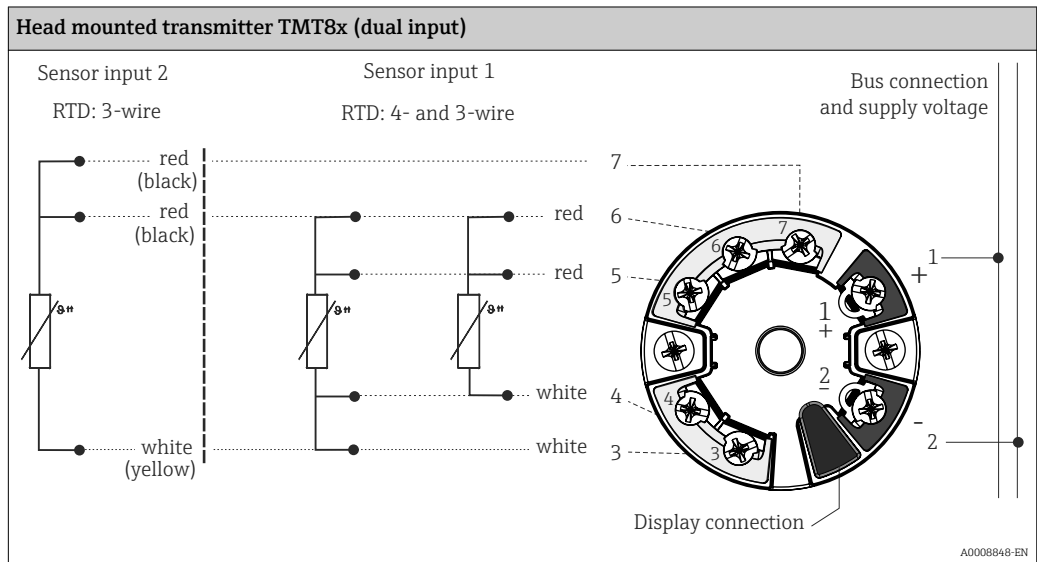
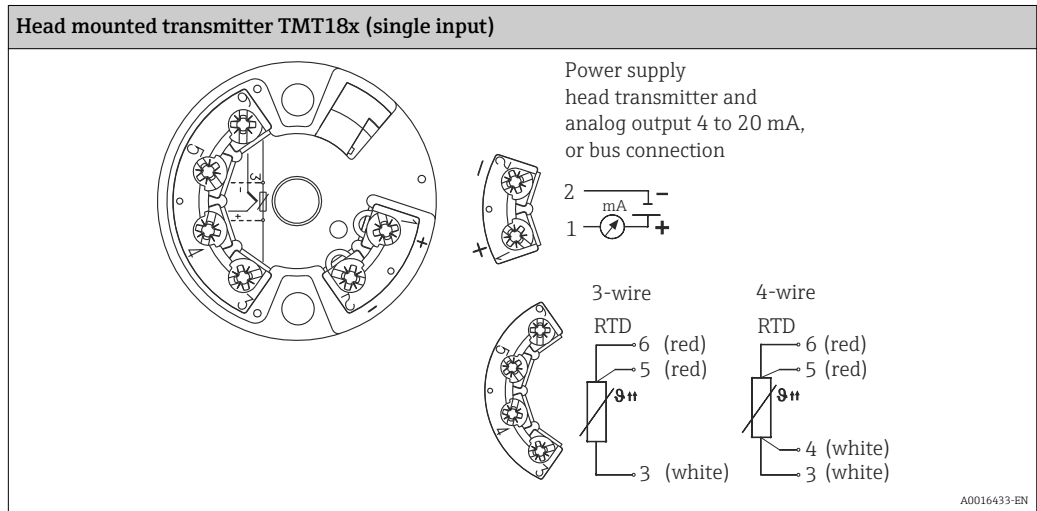

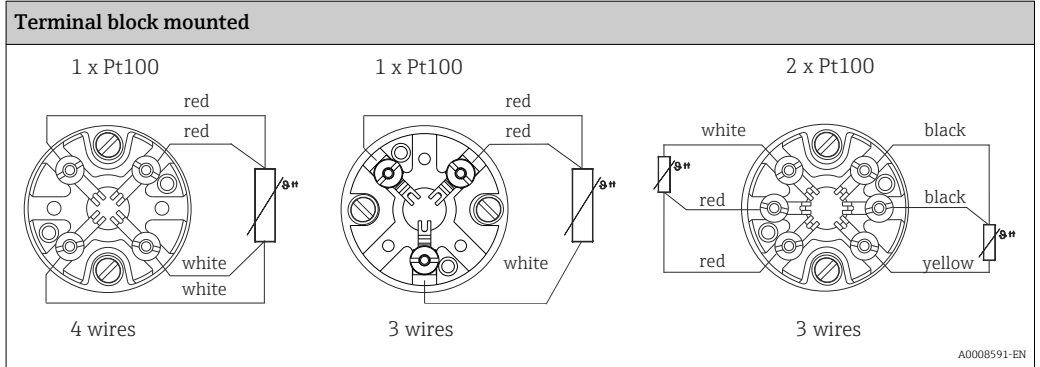

Installation conditions

Orientation

No restrictions.

Installation instructions

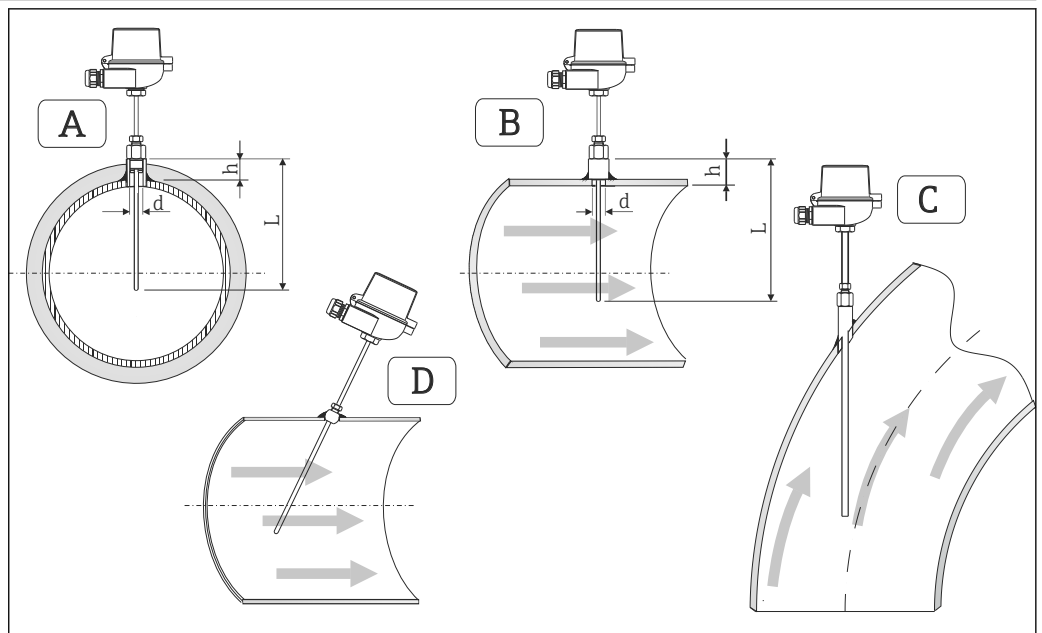

4 Installation examples

A-B In pipes with a small cross section the thermowell tip should reach or extend slightly past the center line of the pipe ($=L$).

C-D Angled installation.

The immersion length of the thermometer influences the accuracy. If the immersion length is too small then errors in the measurement are caused by heat conduction via the process connection and the container wall. If installing into a pipe then the immersion length should be at least half of the pipe diameter. A further solution could be an angled (tilted) installation (see C and D). When determining the immersion length all thermometer parameters and the process to be measured must be taken into account (e.g. flow velocity, process pressure).

- Installation possibilities: Pipes, tanks or other plant components
- Recommended minimum immersion length: 80 to 100 mm (3.15 to 3.94 in)
The immersion length should correspond to at least 8 times of the thermowell diameter. Example: Thermowell diameter 12 mm (0.47 in) x 8 = 96 mm (3.8 in). A standard immersion length of 120 mm (4.72 in) is recommended.
- ATEX certification: Always take note of the installation regulations!

Certificates and approvals

CE mark	The measuring system meets the legal requirements of the applicable EC guidelines. These are listed in the corresponding EC Declaration of Conformity together with the standards applied. Endress+Hauser confirms successful testing of the device by affixing to it the CE mark.
Hazardous area approvals	For further details on the available Ex versions (ATEX, CSA, FM etc.), please contact your nearest Endress+Hauser sales organization. All relevant data for hazardous areas can be found in separate Ex documentation.
Other standards and guidelines	<ul style="list-style-type: none"> ▪ IEC 60529: Degrees of protection provided by enclosures (IP code) ▪ IEC/EN 61010-1: Safety requirements for electrical equipment for measurement, control and laboratory use ▪ IEC 60751: Industrial platinum resistance thermometers ▪ DIN EN 50446: Terminal heads
Material certification	The material certificate 3.1 (according to standard EN 10204) can be requested separately. The "short form" certificate includes a simplified declaration with no enclosures of documents related to the materials used in the construction of the single sensor and guarantees the traceability of the materials through the identification number of the thermometer. The data related to the origin of the materials can subsequently be requested by the client if necessary.
Test report and calibration	The "Factory calibration" is carried out according to an internal procedure in a laboratory of Endress+Hauser accredited by the European Accreditation Organization (EA) to ISO/IEC 17025. A calibration which is performed according to EA guidelines (SIT/Accredia) or (DKD/DakkS) may be requested separately. The calibration is performed on the replaceable insert of the thermometer. In the case of thermometers without a replaceable insert, the entire thermometer - from the process connection to the tip of the thermometer - is calibrated.

Ordering information

Detailed ordering information is available from the following sources:

- In the Product Configurator on the Endress+Hauser website: www.endress.com -> Click "Corporate" -> Select your country -> Click "Products" -> Select the product using the filters and search field -> Open product page -> The "Configure" button to the right of the product image opens the Product Configurator.
- From your Endress+Hauser Sales Center: www.addresses.endress.com









Product Configurator - the tool for individual product configuration

- Up-to-the-minute configuration data
- Depending on the device: Direct input of measuring point-specific information such as measuring range or operating language
- Automatic verification of exclusion criteria
- Automatic creation of the order code and its breakdown in PDF or Excel output format
- Ability to order directly in the Endress+Hauser Online Shop

Accessories

Various accessories, which can be ordered with the device or subsequently from Endress+Hauser, are available for the device. Detailed information on the order code in question is available from your local Endress+Hauser sales center or on the product page of the Endress+Hauser website: www.endress.com.



Communication-specific accessories	Accessories	Description
	Configuration kit TXU10	Configuration kit for PC-programmable transmitter with setup software and interface cable for PC with USB port Order code: TXU10-xx
	Commubox FXA195 HART	For intrinsically safe HART communication with FieldCare via the USB interface.  For details, see "Technical Information" TI00404F
	Commubox FXA291	Connects Endress+Hauser field devices with a CDI interface (= Endress+Hauser Common Data Interface) and the USB port of a computer or laptop.  For details, see "Technical Information" TI00405C
	HART Loop Converter HMX50	Is used to evaluate and convert dynamic HART process variables to analog current signals or limit values.  For details, see "Technical Information" TI00429F and Operating Instructions BA00371F
	Wireless HART adapter SWA70	Is used for the wireless connection of field devices. The WirelessHART adapter can be easily integrated into field devices and existing infrastructures, offers data protection and transmission safety and can be operated in parallel with other wireless networks with minimum cabling complexity.  For details, see Operating Instructions BA061S
	Fieldgate FXA320	Gateway for the remote monitoring of connected 4-20 mA measuring devices via a Web browser.  For details, see "Technical Information" TI00025S and Operating Instructions BA00053S
	Fieldgate FXA520	Gateway for the remote diagnostics and remote configuration of connected HART measuring devices via a Web browser.  For details, see "Technical Information" TI00025S and Operating Instructions BA00051S
	Field Xpert SFX100	Compact, flexible and robust industry handheld terminal for remote configuration and for obtaining measured values via the HART current output (4-20 mA).  For details, see Operating Instructions BA00060S

Service-specific accessories

Accessories	Description
Applicator	Software for selecting and sizing Endress+Hauser measuring devices: <ul style="list-style-type: none"> ▪ Calculation of all the necessary data for identifying the optimum measuring device: e.g. pressure loss, accuracy or process connections. ▪ Graphic illustration of the calculation results Administration, documentation and access to all project-related data and parameters over the entire life cycle of a project. Applicator is available: <ul style="list-style-type: none"> ▪ Via the Internet: https://wapps.endress.com/applicator ▪ On CD-ROM for local PC installation.

Konfigurator ^{+temperature}	<p>Software for selecting and configuring the product depending on the measuring task, supported by graphics. Includes a comprehensive knowledge database and calculation tools:</p> <ul style="list-style-type: none"> ■ For temperature competence ■ Quick and easy design and sizing of temperature measuring points ■ Ideal measuring point design and sizing to suit the processes and needs of a wide range of industries <p>The Konfigurator is available: On request from your Endress+Hauser sales office on a CD-ROM for local PC installation.</p>
W@M	<p>Life cycle management for your plant W@M supports you with a wide range of software applications over the entire process: from planning and procurement, to the installation, commissioning and operation of the measuring devices. All the relevant device information, such as the device status, spare parts and device-specific documentation, is available for every device over the entire life cycle. The application already contains the data of your Endress+Hauser device. Endress+Hauser also takes care of maintaining and updating the data records.</p> <p>W@M is available:</p> <ul style="list-style-type: none"> ■ Via the Internet: www.endress.com/lifecyclemanagement ■ On CD-ROM for local PC installation.
FieldCare	<p>FDT-based plant asset management tool from Endress+Hauser. It can configure all smart field units in your system and helps you manage them. By using the status information, it is also a simple but effective way of checking their status and condition.</p> <p> For details, see Operating Instructions BA00027S and BA00059S</p>

System products

Accessories	Description
Field display unit RIA16	<p>The display unit records the analog measuring signal from the head transmitter and shows this on the display. The LC display shows the current measured value in digital form and as a bar graph indicating a limit value violation. The display unit is looped into the 4 to 20 mA circuit and gets the required energy from there.</p> <p> For details, see the "Technical Information" document TI00144R/09/en</p>
RN221N	<p>Active barrier with power supply for safe separation of 4-20 mA standard signal circuits. Offers bidirectional HART transmission.</p> <p> For details, see "Technical Information" TI00073R and Operating Instructions BA00202R</p>
RNS221	<p>Supply unit for powering two 2-wire measuring devices solely in the non-Ex area. Bidirectional communication is possible via the HART communication jacks.</p> <p> For details, see "Technical Information" TI00081R and Brief Operating Instructions KA00110R</p>

Documentation

Technical Information

- iTEMP Temperature head transmitter
 - TMT180, PC-programmable, single-channel, Pt100 (TI088R/09/en)
 - PCP TMT181, PC-programmable, single-channel, RTD, TC, Ω , mV (TI00070R/09/en)
 - HART® TMT182, single-channel, RTD, TC, Ω , mV (TI078R/09/en)
 - HART® TMT82, two-channel, RTD, TC, Ω , mV (TI01010T/09/en)
 - PROFIBUS® PA TMT84, two-channel, RTD, TC, Ω , mV (TI00138R/09/en)
 - FOUNDATION Fieldbus™ TMT85, two-channel, RTD, TC, Ω , mV (TI00134R/09/en)
- Resistance thermometer insert Omniset TPR100 (TI268t/02/en)

Supplementary ATEX documentation:

- RTD/TC Thermometer Omnigrad TRxx, TCxx, TxCxxx, ATEX II 1GD or II 1/2GD Ex ia IIC T6 to T1 (XA072R/09/a3)
- Omnigrad TRxx, Omniset TPR100, TET10x, TPC100, TEC10x ATEX II 3GD EEx nA (XA00044r/09/a3)
- Inserts Omniset TPR100, TPC100, ATEX/IECEX Ex ia (XA00100T/09/a3)



www.addresses.endress.com
